

NELL DALE & JOHN LEWIS

COMPUTER SCIENCE ILLUMINATED

SEVENTH EDITION



COMPUTER SCIENCE ILLUMINATED

SEVENTH EDITION

NELL DALE
THE UNIVERSITY OF TEXAS AT AUSTIN

JOHN LEWIS
VIRGINIA TECH



JONES & BARTLETT
LEARNING



World Headquarters
Jones & Bartlett Learning
5 Wall Street
Burlington, MA 01803
978-443-5000
info@jblearning.com
www.jblearning.com

Jones & Bartlett Learning books and products are available through most bookstores and online booksellers. To contact Jones & Bartlett Learning directly, call 800-832-0034, fax 978-443-8000, or visit our website, www.jblearning.com.

Substantial discounts on bulk quantities of Jones & Bartlett Learning publications are available to corporations, professional associations, and other qualified organizations. For details and specific discount information, contact the special sales department at Jones & Bartlett Learning via the above contact information or send an email to specialsales@jblearning.com.

Copyright © 2020 by Jones & Bartlett Learning, LLC, an Ascend Learning Company

All rights reserved. No part of the material protected by this copyright may be reproduced or utilized in any form, electronic or mechanical, including photocopying, recording, or by any information storage and retrieval system, without written permission from the copyright owner.

The content, statements, views, and opinions herein are the sole expression of the respective authors and not that of Jones & Bartlett Learning, LLC. Reference herein to any specific commercial product, process, or service by trade name, trademark, manufacturer, or otherwise does not constitute or imply its endorsement or recommendation by Jones & Bartlett Learning, LLC, and such reference shall not be used for advertising or product endorsement purposes. All trademarks displayed are the trademarks of the parties noted herein. *Computer Science Illuminated, Seventh Edition* is an independent publication and has not been authorized, sponsored, or otherwise approved by the owners of the trademarks or service marks referenced in this product.

There may be images in this book that feature models; these models do not necessarily endorse, represent, or participate in the activities represented in the images. Any screenshots in this product are for educational and instructive purposes only. Any individuals and scenarios featured in the case studies throughout this product may be real or fictitious, but are used for instructional purposes only.

15601-0

Production Credits

VP, Product Management: Amanda Martin
Director of Product Management: Laura Pagluica
Product Assistant: Loren-Marie Durr
Director of Production: Jenny L. Corriveau
Project Specialist, Navigate: Rachel DiMaggio
Project Specialist: Alex Schab
Digital Project Specialist: Angela Dooley
Marketing Manager: Michael Sullivan
Product Fulfillment Manager: Wendy Kilborn
Composition: codeMantra U.S. LLC

Cover Design: Kristin E. Parker
Text Design: Kristin E. Parker
Director, Content Services and Licensing: Joanna Gallant
Rights & Media Manager: Shannon Sheehan
Rights & Media Specialist: Thais Miller
Cover Image (Title Page, Part Opener, Chapter Opener):
© Artur Debat/Getty Images; © Alan Dyer/Stocktrek
Images/Getty Images
Printing and Binding: LSC Communications
Cover Printing: LSC Communications

Library of Congress Cataloging-in-Publication Data

Names: Dale, Nell (Nell B.) author. | Lewis, John, 1963- author.
Title: Computer science illuminated / Nell Dale and John Lewis.
Description: Seventh edition. | Burlington, Massachusetts: Jones & Bartlett Learning, [2019] | Includes bibliographical references and index.
Identifiers: LCCN 2018023082 | ISBN 9781284155617 (pbk.)
Subjects: LCSH: Computer science.
Classification: LCC QA76 .D285 2019 | DDC 004—dc23
LC record available at <https://lccn.loc.gov/2018023082>

6048

Printed in the United States of America
22 21 20 19 18 10 9 8 7 6 5 4 3 2 1

© Artur Debat/Getty Images; © Alan Dyer/Stocktrek Images/Getty Images

*To all the students who will use
this book: It is written for you.*

—**Nell Dale**

*To my wife, Sharon, and
our children, Justin, Kayla,
Nathan, and Samantha.*

—**John Lewis**



Nell Dale, The University of Texas at Austin

Well-respected in the field of computer science education, Nell Dale has served on the faculty of The University of Texas at Austin for more than 25 years and has authored over 40 undergraduate computer science textbooks. After receiving her BS in Mathematics and Psychology from the University of Houston, Nell entered The University of Texas at Austin, where she earned her MA in Mathematics and her PhD in Computer Science. Nell has made significant contributions to her discipline through her writing, research, and service. Nell's contributions were recognized in 1996 with the ACM SIGCSE Award for Outstanding Contributions in Computer Science Education and in 2001 with the ACM Karl V. Karlstrom Outstanding Educator Award. She was elected an ACM Fellow in 2010. In 2013, she received the IEEE Taylor L. Booth Education Award. Nell has retired from full-time teaching, giving her more time to write, travel, and play tennis and bridge. She lives in Austin, Texas.

John Lewis, Virginia Tech

John Lewis is a leading educator and author in the field of computer science. He has written a market-leading textbook on Java software and program design. After earning his PhD in Computer Science, John spent 14 years at Villanova University in Pennsylvania. He now teaches computing at Virginia Tech, his alma mater, and works on textbook projects out of his home. He has received numerous teaching awards, including the University Award for Teaching Excellence and the Goff Award for Outstanding Teaching. His professional interests include object-oriented technologies, multimedia, and software engineering. In addition to teaching and writing, John actively participates in the ACM Special Interest Group on Computer Science Education (SIGCSE) and finds time to spend with his family and in his workshop.

BRIEF CONTENTS

© Artur Debat/Getty Images; © Alan Dyer/Stocktrek Images/Getty Images

1 Laying the Groundwork 2

Chapter 1 The Big Picture 3

2 The Information Layer 34

Chapter 2 Binary Values and Number Systems 35

Chapter 3 Data Representation 55

3 The Hardware Layer 92

Chapter 4 Gates and Circuits 93

Chapter 5 Computing Components 121

4 The Programming Layer 150

Chapter 6 Low-Level Programming Languages and Pseudocode 151

Chapter 7 Problem Solving and Algorithms 191

Chapter 8 Abstract Data Types and Subprograms 241

Chapter 9 Object-Oriented Design and High-Level Programming Languages 281

5 The Operating Systems Layer 328

Chapter 10 Operating Systems 329

Chapter 11 File Systems and Directories 361

6 The Applications Layer 386

Chapter 12 Information Systems 387

Chapter 13 Artificial Intelligence 419

Chapter 14 Simulation, Graphics, Gaming, and Other Applications 453

7 The Communications Layer 494

Chapter 15 Networks 495

Chapter 16 The World Wide Web 525

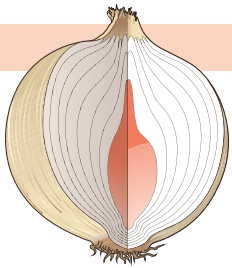
Chapter 17 Computer Security 557

8 In Conclusion 586

Chapter 18 Limitations of Computing 587

CONTENTS

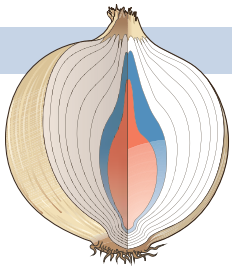
© Amar Debat/Getty Images, © Alan Dyer/Stocktrek Images/Getty Images



1 Laying the Groundwork 2

Chapter 1 The Big Picture 3

- 1.1 Computing Systems 4
 - Layers of a Computing System 4
 - Abstraction 6
- 1.2 The History of Computing 9
 - A Brief History of Computing Hardware 9
 - A Brief History of Computing Software 19
 - Predictions 25
- 1.3 Computing as a Tool and a Discipline 26
 - The Big Ideas of Computing 27
 - Summary 28
 - Ethical Issues: Digital Divide 30
 - Key Terms 31
 - Exercises 31
 - Thought Questions 33



2 The Information Layer 34

Chapter 2 Binary Values and Number Systems 35

- 2.1 Numbers and Computing 36
- 2.2 Positional Notation 36
 - Binary, Octal, and Hexadecimal 38
 - Arithmetic in Other Bases 41
 - Power-of-2 Number Systems 42
 - Converting from Base 10 to Other Bases 44
 - Binary Values and Computers 45
 - Summary 48
 - Ethical Issues: The FISA Court 49
 - Key Terms 49
 - Exercises 50
 - Thought Questions 53

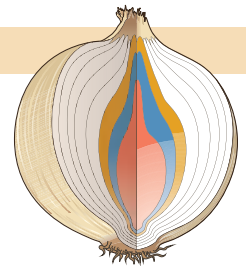
Chapter 3 Data Representation 55

- 3.1 Data and Computers 56
 - Analog and Digital Data 57

- Binary Representations 59
- 3.2** Representing Numeric Data 61
 - Representing Negative Values 61
 - Representing Real Numbers 65
- 3.3** Representing Text 68
 - The ASCII Character Set 69
 - The Unicode Character Set 70
 - Text Compression 71
- 3.4** Representing Audio Data 77
 - Audio Formats 79
 - The MP3 Audio Format 79
- 3.5** Representing Images and Graphics 80
 - Representing Color 80
 - Digitized Images and Graphics 82
 - Vector Representation of Graphics 83
- 3.6** Representing Video 84
 - Video Codecs 84
 - Summary 85
 - Ethical Issues: The Fallout from Snowden's Revelations 86
 - Key Terms 86
 - Exercises 87
 - Thought Questions 91

3 The Hardware Layer 92

- Chapter 4** Gates and Circuits 93
 - 4.1** Computers and Electricity 94
 - 4.2** Gates 96
 - NOT Gate 96
 - AND Gate 97
 - OR Gate 98
 - XOR Gate 98
 - NAND and NOR Gates 99
 - Review of Gate Processing 100
 - Gates with More Inputs 101



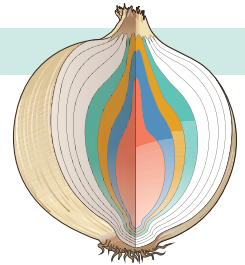
4.3	Constructing Gates	101
	Transistors	102
4.4	Circuits	104
	Combinational Circuits	104
	Adders	108
	Multiplexers	110
4.5	Circuits as Memory	111
4.6	Integrated Circuits	112
4.7	CPU Chips	113
	Summary	113
	Ethical Issues: Codes of Ethics	114
	Key Terms	116
	Exercises	116
	Thought Questions	119
Chapter 5	Computing Components	121
5.1	Individual Computer Components	122
5.2	The Stored-Program Concept	126
	von Neumann Architecture	128
	The Fetch–Execute Cycle	132
	RAM and ROM	134
	Secondary Storage Devices	135
	Touch Screens	139
5.3	Embedded Systems	141
5.4	Parallel Architectures	142
	Parallel Computing	142
	Classes of Parallel Hardware	144
	Summary	145
	Ethical Issues: Is Privacy a Thing of the Past?	146
	Key Terms	146
	Exercises	147
	Thought Questions	149

4 The Programming Layer 150**Chapter 6** Low-Level Programming Languages and Pseudocode 151

- 6.1** Computer Operations 152
- 6.2** Machine Language 152
 - Pep/9: A Virtual Computer 153
 - Input and Output in Pep/9 159
- 6.3** A Program Example 159
 - Pep/9 Simulator 160
 - Another Machine-Language Example 162
- 6.4** Assembly Language 163
 - Pep/9 Assembly Language 164
 - Numeric Data, Branches, and Labels 166
 - Loops in Assembly Language 170
- 6.5** Expressing Algorithms 171
 - Pseudocode Functionality 171
 - Following a Pseudocode Algorithm 175
 - Writing a Pseudocode Algorithm 177
 - Translating a Pseudocode Algorithm 180
- 6.6** Testing 182
 - Summary 183
 - Ethical Issues: Software Piracy 185
 - Key Terms 186
 - Exercises 186
 - Thought Questions 189

Chapter 7 Problem Solving and Algorithms 191

- 7.1** How to Solve Problems 192
 - Ask Questions 193
 - Look for Familiar Things 193
 - Divide and Conquer 194
 - Algorithms 194
 - Computer Problem-Solving Process 196
 - Summary of Methodology 197
 - Testing the Algorithm 198



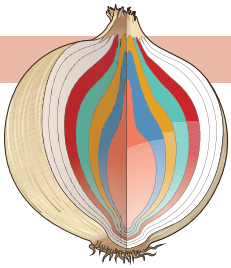
7.2	Algorithms with Simple Variables	199
	An Algorithm with Selection	199
	Algorithms with Repetition	200
7.3	Composite Variables	206
	Arrays	206
	Records	207
7.4	Searching Algorithms	208
	Sequential Search	208
	Sequential Search in a Sorted Array	209
	Binary Search	212
7.5	Sorting	214
	Selection Sort	215
	Bubble Sort	218
	Insertion Sort	220
7.6	Recursive Algorithms	221
	Subprogram Statements	221
	Recursive Factorial	223
	Recursive Binary Search	224
	Quicksort	224
7.7	Important Threads	228
	Information Hiding	228
	Abstraction	229
	Naming Things	230
	Testing	231
	Summary	231
	Ethical Issues: Open-Source Software	232
	Key Terms	234
	Exercises	234
	Thought Questions	239
Chapter 8	Abstract Data Types and Subprograms	241
8.1	What Is an Abstract Data Type?	242
8.2	Stacks	242
8.3	Queues	243
8.4	Lists	244

- 8.5** Trees 247
 - Binary Trees 247
 - Binary Search Trees 249
 - Other Operations 255
- 8.6** Graphs 256
 - Creating a Graph 258
 - Graph Algorithms 259
- 8.7** Subprograms 265
 - Parameter Passing 266
 - Value and Reference Parameters 268
 - Summary 271
 - Ethical Issues: Workplace Monitoring 273
 - Key Terms 274
 - Exercises 274
 - Thought Questions 279
- Chapter 9** Object-Oriented Design and High-Level Programming Languages 281
 - 9.1** Object-Oriented Methodology 282
 - Object Orientation 282
 - Design Methodology 283
 - Example 286
 - 9.2** Translation Process 291
 - Compilers 292
 - Interpreters 292
 - 9.3** Programming Language Paradigms 295
 - Imperative Paradigm 295
 - Declarative Paradigm 296
 - 9.4** Functionality in High-Level Languages 298
 - Boolean Expressions 299
 - Data Typing 301
 - Input/Output Structures 305
 - Control Structures 307
 - 9.5** Functionality of Object-Oriented Languages 313
 - Encapsulation 313
 - Classes 314

Inheritance 316
 Polymorphism 317

9.6 Comparison of Procedural and Object-Oriented Designs 318

Summary 319
 Ethical Issues: Hoaxes and Scams 321
 Key Terms 322
 Exercises 323
 Thought Questions 327



5 The Operating Systems Layer 328

Chapter 10 Operating Systems 329

10.1 Roles of an Operating System 330

Memory, Process, and CPU Management 332
 Batch Processing 333
 Timesharing 334
 Other OS Factors 335

10.2 Memory Management 336

Single Contiguous Memory Management 338
 Partition Memory Management 339
 Paged Memory Management 341

10.3 Process Management 344

The Process States 344
 The Process Control Block 345

10.4 CPU Scheduling 346

First Come, First Served 347
 Shortest Job Next 348
 Round Robin 348

Summary 350
 Ethical Issues: Medical Privacy: HIPAA 352
 Key Terms 353
 Exercises 354
 Thought Questions 359

Chapter 11 File Systems and Directories 361

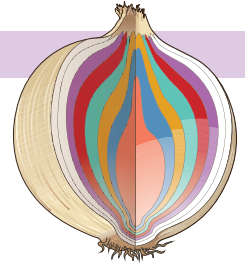
11.1 File Systems 362

Text and Binary Files 362
 File Types 363

- File Operations 365
- File Access 366
- File Protection 367
- 11.2** Directories 368
 - Directory Trees 369
 - Path Names 371
- 11.3** Disk Scheduling 373
 - First-Come, First-Served Disk Scheduling 375
 - Shortest-Seek-Time-First Disk Scheduling 375
 - SCAN Disk Scheduling 376
 - Summary 378
 - Ethical Issues: Privacy: Opt-In or Opt-Out? 380
 - Key Terms 381
 - Exercises 381
 - Thought Questions 385

6 The Applications Layer 386

- Chapter 12** Information Systems 387
 - 12.1** Managing Information 388
 - 12.2** Spreadsheets 389
 - Spreadsheet Formulas 391
 - Circular References 396
 - Spreadsheet Analysis 397
 - 12.3** Database Management Systems 399
 - The Relational Model 399
 - Relationships 403
 - Structured Query Language 404
 - Database Design 405
 - 12.4** E-Commerce 407
 - 12.5** Big Data 408
 - Summary 409
 - Ethical Issues: Politics and the Internet 411
 - Key Terms 413
 - Exercises 413
 - Thought Questions 417



Chapter 13	Artificial Intelligence	419
13.1	Thinking Machines	420
The Turing Test	421	
Aspects of AI	423	
13.2	Knowledge Representation	423
Semantic Networks	425	
Search Trees	427	
13.3	Expert Systems	430
13.4	Neural Networks	432
Biological Neural Networks	432	
Artificial Neural Networks	433	
13.5	Natural-Language Processing	435
Voice Synthesis	437	
Voice Recognition	438	
Natural-Language Comprehension	439	
13.6	Robotics	440
The Sense–Plan–Act Paradigm	441	
Subsumption Architecture	441	
Physical Components	443	
Summary	445	
Ethical Issues: Initial Public Offerings	447	
Key Terms	448	
Exercises	448	
Thought Questions	451	
Chapter 14	Simulation, Graphics, Gaming, and Other Applications	453
14.1	What Is Simulation?	454
Complex Systems	454	
Models	455	
Constructing Models	455	
14.2	Specific Models	457
Queuing Systems	457	
Meteorological Models	461	
Computational Biology	466	

- Other Models 467
- Computing Power Necessary 467
- 14.3** Computer Graphics 468
 - How Light Works 470
 - Object Shape Matters 472
 - Simulating Light 472
 - Modeling Complex Objects 474
 - Getting Things to Move 480
- 14.4** Gaming 482
 - History of Gaming 483
 - Creating the Virtual World 484
 - Game Design and Development 485
 - Game Programming 486
 - Summary 487
 - Ethical Issues: Gaming as an Addiction 489
 - Key Terms 490
 - Exercises 490
 - Thought Questions 493

7 The Communications Layer 494

- Chapter 15** Networks 495
 - 15.1** Networking 496
 - Types of Networks 497
 - Internet Connections 500
 - Packet Switching 502
 - 15.2** Open Systems and Protocols 504
 - Open Systems 504
 - Network Protocols 505
 - TCP/IP 506
 - High-Level Protocols 507
 - MIME Types 508
 - Firewalls 509
 - 15.3** Network Addresses 510
 - Domain Name System 511
 - Who Controls the Internet? 514

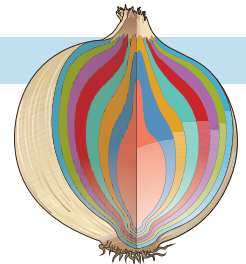


15.4	Cloud Computing	515
15.5	Blockchain	516
	Summary	517
	Ethical Issues: The Effects of Social Networking	519
	Key Terms	520
	Exercises	521
	Thought Questions	523
Chapter 16	The World Wide Web	525
16.1	Spinning the Web	526
	Search Engines	527
	Instant Messaging	528
	Weblogs	529
	Cookies	530
	Web Analytics	530
16.2	HTML and CSS	531
	Basic HTML Elements	535
	Tag Attributes	536
	More About CSS	537
	More HTML5 Elements	540
16.3	Interactive Web Pages	541
	Java Applets	541
	Java Server Pages	542
16.4	XML	543
16.5	Social Network Evolution	547
	Summary	548
	Ethical Issues: Gambling and the Internet	551
	Key Terms	552
	Exercises	552
	Thought Questions	555
Chapter 17	Computer Security	557
17.1	Security at All Levels	558
	Information Security	558

- 17.2** Preventing Unauthorized Access 560
 - Passwords 561
 - CAPTCHA 563
 - Fingerprint Analysis 564
- 17.3** Malicious Code 565
 - Antivirus Software 566
 - Security Attacks 567
- 17.4** Cryptography 569
- 17.5** Protecting Your Information Online 572
 - Corporate Responsibility 574
 - Security and Portable Devices 574
 - WikiLeaks 575
 - Summary 578
 - Ethical Issues: Blogging and Journalism 580
 - Key Terms 581
 - Exercises 582
 - Thought Questions 585

8**In Conclusion 586****Chapter 18** Limitations of Computing 587

- 18.1** Hardware 588
 - Limits on Arithmetic 588
 - Limits on Components 594
 - Limits on Communications 595
- 18.2** Software 596
 - Complexity of Software 596
 - Current Approaches to Software Quality 597
 - Notorious Software Errors 602
- 18.3** Problems 604
 - Comparing Algorithms 605
 - Turing Machines 612
 - Halting Problem 615
 - Classification of Algorithms 617



Summary	619
Ethical Issues: Therac-25: Anatomy of a Disaster	620
Key Terms	621
Exercises	621
Thought Questions	624
Glossary	625
Endnotes	651
Index	661

PREFACE

© Artur Debat/Getty Images; © Alan Dyer/Stocktrek Images/Getty Images

Choice of Topics

In putting together the outline of topics for this CS0 text, we used many sources. We looked at course catalogue descriptions and book outlines, and we administered a questionnaire designed to find out what you, our colleagues, thought should be included in such a course. We asked you and ourselves to do the following:

- Please list four topics that you feel students should master in a CS0 course if this is the only computer science course they will take during their college experience.
- Please list four topics that you would like students entering your CS1 course to have mastered.
- Please list four additional topics that you would like your CS1 students to be familiar with.

The strong consensus that emerged from the intersections of these sources formed the working outline for this book. It serves as a core CS0 text, providing a breadth-first introduction to computing. It is appropriate for use for a course embracing the AP Computer Science Principles curriculum, and alternatively as a companion or lead-in to a programming intensive course.

Rationale for Organization

This book begins with the history of hardware and software, showing how a computer system is like an onion. The processor and its machine language form the heart of the onion, and layers of software and more sophisticated hardware have been added around this heart, layer by layer. At the next layer, higher-level languages such as FORTRAN, Lisp, Pascal, C, C++, and Java were introduced parallel to the ever-increasing exploration of the programming process, using such tools as top-down design and object-oriented design. Over time, our understanding of the role of abstract data types and their implementations matured. The operating system, with its resource-management techniques—including files on ever-larger, faster secondary storage media—developed to surround and manage these programs.

The next layer of the computer system “onion” is composed of sophisticated general-purpose and special-purpose software systems that

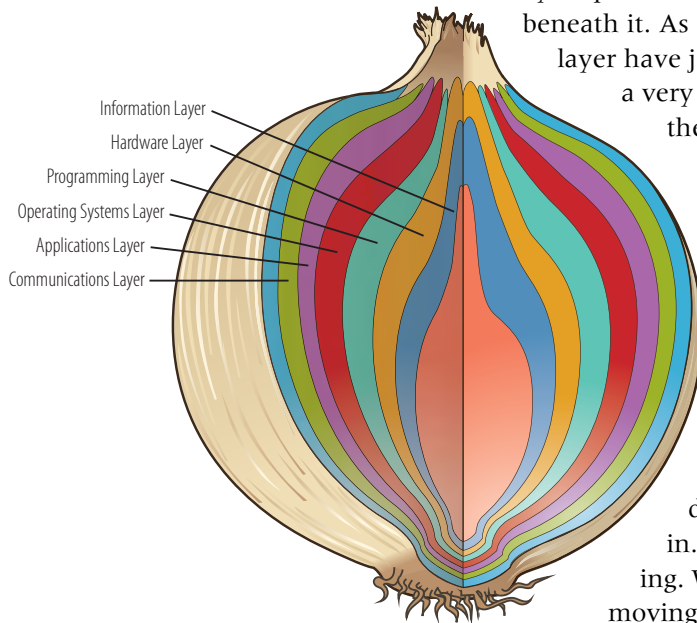
overlay the operating system. Development of these powerful programs was stimulated by theoretical work in computer science, which makes such programs possible. The final layer comprises networks and network software—that is, the tools needed for computers to communicate with one another. The Internet and the World Wide Web put the finishing touches to this layer, and this text culminates with a discussion of security issues affecting our interaction online.

As these layers have grown over the years, the user has become increasingly insulated from the computer system's hardware. Each of these layers provides an abstraction of the computing system beneath it. As each layer has evolved, users of the new layer have joined with users of inner layers to create a very large workforce in the high-tech sector of

the global economy. This book is designed to provide an overview of the layers, introducing the underlying hardware and software technologies, in order to give students an appreciation and understanding of all aspects of computing systems.

Having used history to describe the formation of the onion from the inside out, we were faced with a design choice: We could look at each layer in depth from the inside out or the outside in. The outside-in approach was very tempting. We could peel the layers off one at a time, moving from the most abstract layer to the concrete machine. However, research has shown that

students understand concrete examples more easily than abstract ones, even when the students themselves are abstract thinkers. Thus, we have chosen to begin with the concrete machine and examine the layers in the order in which they were created, trusting that a thorough understanding of one layer makes the transition to the next abstraction easier for the students.



Changes in the Seventh Edition

As always when planning a revision, we asked our colleagues, including many current users of the text, to give us feedback. We appreciate the many thoughtful and insightful responses we received.

A variety of changes have been made throughout the book with the *Seventh Edition*. One includes a conscious effort to improve our coverage of the specific topics described in the AP Computer Science Principles curriculum. This book was already a good match for that approach, but the curriculum provided a wealth of ideas for updated content, both large and small. An overview of the Big Ideas in computing that form the high-level framework of the Principles curriculum is now included in Chapter 1.

Among the other larger changes with this edition are a stronger introduction to cloud computing, an updated example computer specification described in Chapter 5, a discussion of spreadsheet visualization and an introduction to big data in Chapter 12, a discussion of smart speakers such as Amazon Echo and Google Home in Chapter 13, a discussion of blockchain in Chapter 15, and updated security discussions in Chapter 17.

Another big change in the *Seventh Edition* is a complete overhaul of Chapter 6 to update the text and examples to use the Pep/9 machine. Several improvements were made to the underlying system in the upgrade from Pep/8 that help the explanations of programming at the machine-language and assembly levels.

In addition, the special features throughout the book have been completely revised and augmented. The “Ethical Issues” sections at the end of each chapter have been brought up to date, addressing the ever-changing state of those issues. Several additional “Did You Know?” sidebars have been added and many others updated. Finally, the biographical sketches throughout the book have been updated.

As with each edition, the entire text has been reviewed for opportunities to improve the coverage, presentation, and examples used. Updated (and sometimes streamlined) text throughout the book helps to clarify the topics presented.

Synopsis

Chapter 1 lays the groundwork, as described in the “Rationale for This Book’s Organization” section above. **Chapters 2** and **3** step back and examine a layer that is embodied in the physical hardware. We call this the “information layer” because it reflects how data is represented in the computer. Chapter 2 covers the binary number system and its relationship to other number systems such as decimal (the one we humans use on a daily basis). Chapter 3 investigates how we take the myriad types of data we manage—numbers, text, images, audio, and video—and represent them in a computer in binary format.

Chapters 4 and **5** discuss the hardware layer. Computer hardware includes devices such as transistors, gates, and circuits, all of which control the flow of electricity in fundamental ways. This core electronic circuitry gives rise to specialized hardware components like the computer’s central processing unit (CPU) and memory. Chapter 4 covers gates and electronic circuits; Chapter 5 focuses on the hardware components of a computer and how they interact within a von Neumann architecture.

Chapters 6 through **9** examine aspects of the programming layer. Chapter 6 explores the concepts of both machine-language and assembly-language programming using Pep/9, a simulated computer. We discuss the functionality of pseudocode as a way to write algorithms. The concepts of looping and selection are introduced here, expressed in pseudocode, and implemented in Pep/9.

Chapter 7 examines the problem-solving process as it relates to both humans and computers. George Polya’s human problem-solving strategies guide the discussion. Top-down design is presented as a way to design simple algorithms. We choose classic searching and sorting algorithms as the context for the discussion of algorithms. Because algorithms operate on data, we examine ways to structure data so that it can be more efficiently processed. We also introduce subalgorithm (subprogram) statements.

Chapter 8 explores abstract data types and containers: composite structures for which we know only properties or behaviors. Lists, sorted lists, stacks, queues, binary search trees, and graphs are discussed. The section on subalgorithms is expanded to include reference and value parameters and parameter passing.

Chapter 9 covers the concepts of high-level programming languages. Because many prominent high-level languages include functionality associated with object-oriented programming, we detour and first present this design process. Language paradigms and the compilation process are discussed. Pseudocode concepts are illustrated in brief examples from four programming languages: Python, Visual Basic .NET, C++, and Java.

Chapters 10 and **11** cover the operating system layer. Chapter 10 discusses the resource management responsibilities of the operating system and presents some of the basic algorithms used to implement these tasks. Chapter 11 focuses on file systems, including what they are and how they are managed by the operating system.

Chapters 12 through **14** cover the application layer. This layer is made up of the general-purpose and specialized application programs that are available to the public for solving programs. We divide this layer into the sub-disciplines of computer science upon which these programs are based. Chapter 12 examines information systems, Chapter 13 examines artificial intelligence, and Chapter 14 examines simulation, graphics, gaming, and other applications.

Chapters 15 through **17** cover the communication layer. Chapter 15 presents the theoretical and practical aspects of computers communicating with each other. Chapter 16 discusses the World Wide Web and the various technologies involved. Chapter 17 examines computer security and keeping information protected in the modern information age.

Chapters 2 through 17 are about what a computer can do and how. **Chapter 18** concludes the text with a discussion of the inherent limitations of computer hardware and software, including the problems that can and cannot be solved using a computer. We present Big-O notation as a way to talk about the efficiency of algorithms so that the categories of algorithms can be discussed, and we use the halting problem to show that some problems are unsolvable.

The first and last chapters form bookends: Chapter 1 describes what a computing system is and Chapter 18 cautions about what a computing system is not. The chapters between take an in-depth look at the layers that make up a computing system.

Why Not a Language?

Instead of championing a specific programming language such as Java, C++, or something else, we decided to leave the choice to the user. Introductory chapters, formatted in a manner consistent with the design of this book, are available for Java, C++, JavaScript, Visual Basic, .NET, Python, SQL, Ruby, Perl, Alice, and Pascal on the book's website.

If the students have enough knowledge and experience to master the introductory syntax and semantics of a language in addition to the background material in this book, simply have the students download the appropriate chapter. As an alternative, one or all of these chapters can be used to enrich the studies of those who have stronger backgrounds.

Special Features

We have included three special features in this text in order to emphasize the history and breadth of computing as well as the moral obligations that come with new technology.

Biographies

Each chapter includes a short biography of someone who has made a significant contribution to computing as we know it. The people honored in these sections range from those who contributed to the data layer, such as George Boole and Ada Lovelace, to those who have contributed to the communication layer, such as Doug Engelbart and Tim Berners-Lee. These biographies give students a taste of history and introduce them to the men and women who are pioneers in the world of computing.

10.4 CPU Scheduling

349

Steve Jobs

Born in 1955, Steve Jobs is probably best known for founding Apple Computer together with Steve Wozniak and Ronald Wayne in 1976. At the time, most computers were either mainframes (sometimes as large as a small room) or minicomputers (about the size of a refrigerator), often anything but user-friendly, and almost exclusively used by big businesses. Jobs had a vision of a personal computer that would be accessible to everyone. He is often credited with democratizing the computer.

Jobs and Wozniak designed the Apple I in Jobs's bedroom and built it in the garage of his parents' house. Jobs and Wozniak sold their prize possessions (a Volkswagen microbus and a Hewlett-Packard scientific calculator, respectively) to raise the \$1300 capital with which they founded their company. Four years later, Apple went public. At the end of the first day of trading, the company had a market value of \$1.2 billion.

Jobs headed the team that developed the Apple Macintosh (named after the McIntosh apple), perhaps the most famous of the Apple computers. The Macintosh was the first commercially successful computer to be launched with a graphical user interface. After the launch

Having been ousted from the company he founded, Jobs began another computer company, NeXT, which was purchased by Apple in 1996 for \$402 million. Not only did the acquisition bring Jobs back to his original company, but it also made him CEO of Apple. Under his renewed leadership, Apple launched the iMac, which has been described as the "gold standard of desktop computing."

In 1986, Jobs moved into the field of computer-generated animation when he bought a computer graphics company and renamed it *Pixar*. Pixar has produced a number of box office hits, including *A Bug's Life*, *Toy Story*, *Monsters, Inc.*, and *Finding Nemo*.

Jobs, himself a university dropout, gave the 2005 commencement address at Stanford University, in which he imparted the following piece of career advice to the graduates: "You've got to find what you love."

In 2007 Jobs was named the most powerful person in business by *Fortune* magazine, and Governor Arnold Schwarzenegger inducted Jobs into the California Hall of Fame. In August 2011 Jobs resigned as CEO of Apple; he was elected Chairman of the Board. Tim Cook took over as CEO of Apple. After a long career



© Christopher Ho/W Photo

Did You Know

Our second feature (the “Did You Know?” sections indicated by a question mark) comprises sidebars that include interesting tidbits of information from the past, present, and future. They are garnered from history, current events, and the authors’ personal experiences. These little vignettes are designed to amuse, inspire, intrigue, and, of course, educate.

Ethical Issues

Our third feature is an “Ethical Issues” section that is included in each chapter. These sections illustrate the fact that along with the advantages of computing come responsibilities for and consequences of its use. Privacy, hacking, viruses, and free speech are among the topics discussed. Following the exercises in each chapter, a “Thought Questions” section asks stimulating questions about these ethical issues as well as chapter content.

Color and Typography Are Signposts

The layers into which the book is divided are color coded within the text. The opening spread for each chapter shows an image of the onion in which the outermost color corresponds to the current layer. This color is repeated in header bars and section numbers throughout the layer. Each opening spread also visually indicates where the chapter is within the layer and the book.

We have said that the first and last chapters form bookends. Although they are not part of the layers of the computing onion, these chapters are

?

Virtual games and national security

U.S. and British spies have infiltrated the fantasy world of virtual games. A 2008 National Security Agency (NSA) document declared that virtual games provide a “target-rich communication network” that allows intelligence suspects a way to communicate and “hide in plain sight.”⁴



ETHICAL ISSUES

The FISA Court

The United States Foreign Intelligence Surveillance Court is a U.S. federal court that was established under the Foreign Intelligence Surveillance Act of 1978 (FISA). The Court handles requests by federal law enforcement agencies for surveillance warrants against suspected foreign intelligence agents operating inside the United States.⁴

Before 2013, when Edward Snowden leaked that the Court had ordered a subsidiary of Verizon to provide detailed call records to the National Security Agency (NSA), most people had never heard of the FISA Court.

The FISA Court comprises 11 judges who sit for 7-year terms. The Chief Justice of the Supreme Court appoints the judges, without confirmation. An application for an electronic surveillance warrant is made before one of the judges. The court may amend this application before granting the warrant. If the application is denied, the government may not take the same request to another judge. If

the U.S. Attorney General determines that an emergency exists, he or she may authorize the electronic surveillance but must notify a Court judge not more than 72 hours after the authorization. The USA PATRIOT Act of 2001 expanded the time periods during which surveillance may be authorized.⁵

In December 2012, President Obama signed the FISA Amendments Act Reauthorization Act of 2012, which extended Title VII of FISA until December 31, 2017. In January, 2018, President Trump reauthorized it again through 2023.

Title VII of FISA, added by the FISA Amendments Act of 2008, created separate procedures for targeting suspected foreign intelligence agents, including non-U.S. persons and U.S. persons reasonably believed to be outside the United States.⁶

Note that the stated intent of the FISA Court is to protect the United States as well as the rights of U.S. citizens.

color coded like the others. Open the book anywhere and you can immediately tell where you are within the layers of computing.

To visually separate the abstract from the concrete in the programming layer, we use different fonts for algorithms, including identifiers in running text, and program code. You know at a glance whether the discussion is at the logical (algorithmic) level or at the programming-language level. In order to distinguish visually between an address and the contents of an address, we color addresses in orange.

Color is especially useful in Chapter 6, “Low-Level Programming Languages and Pseudocode.” Instructions are color coded to differentiate the parts of an instruction. The operation code is blue, the register designation is clear, and the addressing mode specifier is green. Operands are shaded gray. As in other chapters, addresses are in orange.

Instructor Resources

For the instructor, slides in PowerPoint format, a test bank, and answers to the book’s end-of-chapter exercises are available for free download at <http://go.jblearning.com/CSI7e>.

ACKNOWLEDGMENTS

© Artur Debat/Getty Images; © Alan Dyer/Stocktrek Images/Getty Images

Our adopters have been most helpful during this revision. To those who took the time to respond to our online survey: Thanks to all of you. We are also grateful to the reviewers of the previous editions of the text:

Warren W. Sheaffer, Saint Paul College
Tim Bower, Kansas State University
Terri Grote, St. Louis Community College
Susan Glenn, Gordon State College
Simon Sultana, Fresno Pacific University
Shruti Nagpal, Worcester State University
Sandy Keeter, Seminole State College of Florida
S. Monisha Pulimood, The College of New Jersey
Roy Thelin, Ridge Point High School
Robert Yacobellis, Loyola University Chicago
Richard Croft, Eastern Oregon University
Raymond J. Curts, George Mason University
Mia Moore, Clark Atlanta University
Melissa Stange, Lord Fairfax Community College
Matthew Hayes, Xavier University of Louisiana
Marie Arvi, Salisbury University
Linda Ehley, Alverno College
Keson Khieu, Sierra College
Keith Coates, Drury University
Joon Kim, Brentwood School
Joe Melanson, Corning Painted Post
Joan Lucas, College at Brockport, State University of New York
Jeffrey L. Lehman, Huntington University
Janet Helwig, Dominican University
James Thomas Davis, A. Crawford Mosley High School
James Hicks, Los Angeles Southwest College
Jacquilin Porter, Henry Ford College and Baker College
Homer Sharafi, Northern Virginia Community College
Gil Eckert, Monmouth University
Gary Monnard, St. Ambrose University
David Klein, Hofstra University
David Adams, Grove City College
Christopher League, LIU Brooklyn

Carol Sweeney, Villa Maria Academy High School
Brian Bradshaw, Thiel College
Bill Cole, Sierra College-Rocklin
Aparna Mahadev, Worcester State University
Anna Ursyn, UNC Colorado
Ann Wojnar, Beaumont School

Special thanks to Jeffrey McConnell of Canisius College, who wrote the graphics section in Chapter 14; Herman Tavani of Rivier College, who helped us revise the “Ethical Issues” sections; Richard Spinello of Boston College for his essay on the ethics of blogging; and Paul Toprac, Associate Director of Game Development at The University of Texas at Austin, for his contributions on gaming.

We appreciate and thank our reviewers and colleagues who provided advice and recommendations for the content in this *Seventh Edition*:

Tim Bower, Kansas State University
Brian Bradshaw, Thiel College
Keith Coates, Drury University
Raymond J. Curts, George Mason University
James Thomas Davis, A. Crawford Mosley High School
Gil Eckert, Monmouth University
Susan Glenn, Gordon State College
Terri Grote, St. Louis Community College
Matthew Hayes, Xavier University of Louisiana
Sandy Keeter, Seminole State College of Florida
Keson Khieu, Sierra College
Joon Kim, Brentwood School
David Klein, Hofstra University
Christopher League, LIU Brooklyn
Jeffrey L. Lehman, Huntington University
Joan Lucas, College at Brockport, State University of New York
Joe Melanson, Corning Painted Post
Gary Monnard, St. Ambrose University
Shruti Nagpal, Worcester State University
Jacquilin Porter, Henry Ford College and Baker College
Homer Sharafi, Northern Virginia Community College

Melissa Strange, Lord Fairfax Community College
Simon Sultana, Fresno Pacific University
Carol Sweeney, Villa Maria Academy High School
Roy Thelin, Ridge Point High School
Anna Ursyn, UNC Colorado
Ann Wojnar, Beaumont School

We also thank the many people at Jones & Bartlett Learning who contributed so much, especially Laura Pagluica, Director of Product Management; Loren-Marie Durr, Product Assistant; and Alex Schab, Project Specialist.

I must also thank my tennis buddies for keeping me fit, my bridge buddies for keeping my mind alert, and my family for keeping me grounded.

—ND

I'd like to thank my family for their support.

—JL

SPECIAL FEATURES

© Amar Debat/Getty Images, © Alan Dyer/Stocktrek Images/Getty Images

Interspersed throughout *Computer Science Illuminated, Seventh Edition*, are two special features of note: Ethical Issues and Biographies. A list of each is provided below for immediate access.

ETHICAL ISSUES

- Digital Divide (Chapter 1, p. 30)
- The FISA Court (Chapter 2, p. 49)
- The Fallout from Snowden's Revelations (Chapter 3, p. 86)
- Codes of Ethics (Chapter 4, p. 114)
- Is Privacy a Thing of the Past? (Chapter 5, p. 146)
- Software Piracy (Chapter 6, p. 185)
- Open-Source Software (Chapter 7, p. 232)
- Workplace Monitoring (Chapter 8, p. 273)
- Hoaxes and Scams (Chapter 9, p. 321)
- Medical Privacy: HIPAA (Chapter 10, p. 352)
- Privacy: Opt-In or Opt-Out? (Chapter 11, p. 380)
- Politics and the Internet (Chapter 12, p. 411)
- Initial Public Offerings (Chapter 13, p. 447)
- Gaming as an Addiction (Chapter 14, p. 489)
- The Effects of Social Networking (Chapter 15, p. 519)
- Gambling and the Internet (Chapter 16, p. 551)
- Blogging and Journalism (Chapter 17, p. 580)
- Therac-25: Anatomy of a Disaster (Chapter 18, p. 620)

BIOGRAPHIES

Ada Lovelace, the First Programmer (Chapter 1, p. 14)

Grace Murray Hopper (Chapter 2, p. 46)

Bob Bemer (Chapter 3, p. 72)

George Boole (Chapter 4, p. 95)

John Vincent Atanasoff (Chapter 5, p. 127)

Konrad Zuse (Chapter 6, p. 181)

George Polya (Chapter 7, p. 195)

John von Neumann (Chapter 8, p. 248)

Edsger Dijkstra (Chapter 9, p. 309)

Steve Jobs (Chapter 10, p. 349)

Tony Hoare (Chapter 11, p. 377)

Daniel Bricklin (Chapter 12, p. 395)

Herbert A. Simon (Chapter 13, p. 424)

Ivan Sutherland (Chapter 14, p. 462)

Doug Engelbart (Chapter 15, p. 503)

Tim Berners-Lee (Chapter 16, p. 538)

Mavis Batey (Chapter 17, p. 576)

Alan Turing (Chapter 18, p. 613)

Laying the Groundwork

1 The Big Picture

The Information Layer

- 2 Binary Values and Number Systems
- 3 Data Representation

The Hardware Layer

- 4 Gates and Circuits
- 5 Computing Components

The Programming Layer

- 6 Low-Level Programming Languages and Pseudocode
- 7 Problem Solving and Algorithms
- 8 Abstract Data Types and Subprograms
- 9 Object-Oriented Design and High-Level Programming Languages

The Operating Systems Layer

- 10 Operating Systems
- 11 File Systems and Directories

The Applications Layer

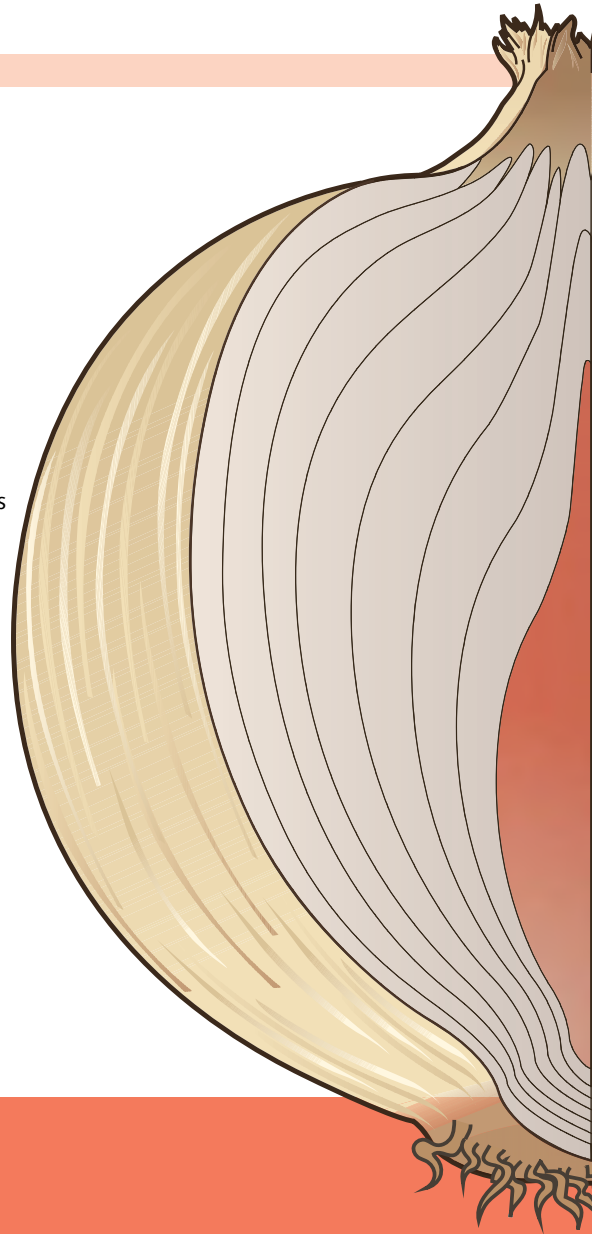
- 12 Information Systems
- 13 Artificial Intelligence
- 14 Simulation, Graphics, Gaming, and Other Applications

The Communications Layer

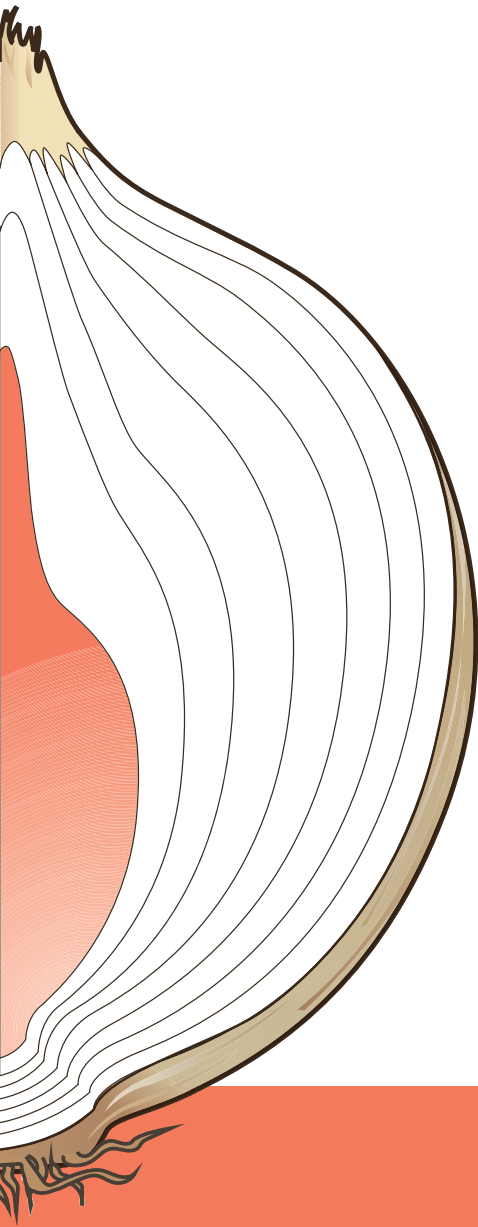
- 15 Networks
- 16 The World Wide Web
- 17 Computer Security

In Conclusion

- 18 Limitations of Computing



LAYING THE GROUNDWORK



1

THE BIG PICTURE

This book is a tour through the world of computing. We explore how computers work—what they do and how they do it, from bottom to top, inside and out. Like an orchestra, a computer system is a collection of many different elements, which combine to form a whole that is far more than the sum of its parts. This chapter provides the big picture, giving an overview of the pieces that we slowly dissect throughout the book and putting those pieces into historical perspective.

Hardware, software, programming, web surfing, and email are probably familiar terms to you. Some of you can define these and many more computer-related terms explicitly, whereas others may have only a vague, intuitive understanding of them. This chapter gets everyone on relatively equal footing by establishing common terminology and creating the platform from which we will dive into our exploration of computing.

GOALS

After studying this chapter, you should be able to:

- describe the layers of a computer system.
- describe the concept of abstraction and its relationship to computing.
- describe the history of computer hardware and software.
- describe the changing role of the computer user.
- distinguish between systems programmers and applications programmers.
- distinguish between computing as a tool and computing as a discipline.

Computing system

Computer hardware, software, and data, which interact to solve problems

Computer hardware

The physical elements of a computing system

Computer software

The programs that provide the instructions that a computer executes

1.1 Computing Systems

In this book we explore various aspects of computing systems. Note that we use the term *computing system*, not just *computer*. A computer is a device. A **computing system**, by contrast, is a dynamic entity, used to solve problems and interact with its environment. A computing system is composed of hardware, software, and the data that they manage. **Computer hardware** is the collection of physical elements that make up the machine and its related pieces: boxes, circuit boards, chips, wires, disk drives, keyboards, monitors, printers, and so on. **Computer software** is the collection of programs that provide the instructions that a computer carries out. And at the very heart of a computer system is the information that it manages. Without data, the hardware and software are essentially useless.

The general goals of this book are threefold:

- To give you a solid, broad understanding of how a computing system works
- To help you develop an appreciation for and understanding of the evolution of modern computing systems
- To give you enough information about computing so that you can decide whether you wish to pursue the subject further

The rest of this section explains how computer systems can be divided into abstract layers and how each layer plays a role. The next section puts the development of computing hardware and software into historical context. This chapter concludes with a discussion about computing as both a tool and a discipline of study.

Layers of a Computing System

A computing system is like an onion, made up of many layers. Each layer plays a specific role in the overall design of the system. These layers are depicted in **FIGURE 1.1** and form the general organization of this book. This is the “big picture” that we will continually return to as we explore different aspects of computing systems.

You rarely, if ever, take a bite out of an onion as you would an apple. Rather, you separate the onion into concentric rings. Likewise, in this book we explore aspects of computing one layer at a time. We peel each layer separately and explore it by itself. Each layer, in itself, is not that complicated. In fact, a computer actually does only very simple tasks—it just does them so blindingly fast that many simple tasks can be combined

to accomplish larger, more complicated tasks. When the various computer layers are all brought together, each playing its own role, amazing things result from the combination of these basic ideas.

Let's discuss each of these layers briefly and identify where in this book these ideas are explored in more detail. We essentially work our way from the inside out, which is sometimes referred to as a *bottom-up approach*.

The innermost layer, information, reflects the way we represent information on a computer. In many ways this is a purely conceptual level. Information on a computer is managed using binary digits, 1 and 0. So to understand computer processing, we must first understand the binary number system and its relationship to other number systems (such as the decimal system, the one humans use on a daily basis). Then we can turn our attention to how we take the myriad types of information we manage—numbers, text, images, audio, and video—and represent them in a binary format. Chapters 2 and 3 explore these issues.

The next layer, hardware, consists of the physical hardware of a computer system. Computer hardware includes devices such as gates and circuits, which control the flow of electricity in fundamental ways. This core electronic circuitry gives rise to specialized hardware components such as the computer's central processing unit (CPU) and memory. Chapters 4 and 5 of the book discuss these topics in detail.

The programming layer deals with software, the instructions used to accomplish computations and manage data. Programs can take many forms, be performed at many levels, and be implemented in many languages. Yet, despite the enormous variety of programming issues, the goal remains the same: to solve problems. Chapters 6 through 9 explore many issues related to programming and the management of data.

Every computer has an operating system (OS) to help manage the computer's resources. Operating systems, such as Windows, Mac OS, or Linux, help us interact with the computer system and manage the way hardware devices, programs, and data interact. Knowing what an operating system does is key to understanding the computer in general. These issues are discussed in Chapters 10 and 11.

The previous (inner) layers focus on making a computer system work. The applications layer, by contrast, focuses on using the computer to solve specific real-world problems. We run application programs to

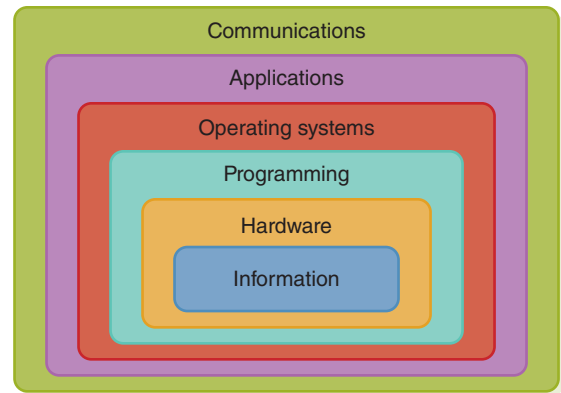


FIGURE 1.1 The layers of a computing system

take advantage of the computer's abilities in other areas, such as helping us design a building or play a game. The spectrum of area-specific computer software tools is far-reaching and involves specific subdisciplines of computing, such as information systems, artificial intelligence, and simulation. Application systems are discussed in Chapters 12, 13, and 14.

Of course, computers no longer exist in isolation on someone's desktop. We use computer technology to communicate, and that communication is a fundamental layer at which computing systems operate. Computers are connected into networks so that they can share information and resources. The Internet evolved into a global network, so there is now almost no place on Earth you can't reach with computing technology. The World Wide Web makes that communication easier; it has revolutionized computer use and made it accessible to the general public. Cloud computing is the idea that our computing needs can be handled by resources at various places on the Internet (in the cloud), rather than on local computers. Chapters 15 and 16 discuss these important issues of computing communication.

The use of computing technology can result in increased security hazards. Some issues of security are dealt with at low levels throughout a computer system. Many of them, though, involve keeping our personal information secure. Chapter 17 discusses several of these issues.

Most of this book focuses on what a computer can do and how it does it. We conclude the book with a discussion of what a computer *cannot* do, or at least cannot do well. Computers have inherent limitations on their ability to represent information, and they are only as good as their programming makes them. Furthermore, it turns out that some problems cannot be solved at all. Chapter 18 examines these limitations of computers.

Sometimes it is easy to get so caught up in the details that we lose perspective on the big picture. Try to keep that in mind as you progress through the information in this book. Each chapter's opening page reminds you of where we are in the various layers of a computing system. The details all contribute a specific part to a larger whole. Take each step in turn and you will be amazed at how well it all falls into place.

Abstraction

The levels of a computing system that we just examined are examples of abstraction. An **abstraction** is a mental model, a way to think about something, that removes or hides complex details. An abstraction includes the information necessary to accomplish our goal, but leaves out information that would unnecessarily complicate matters. When we are dealing with

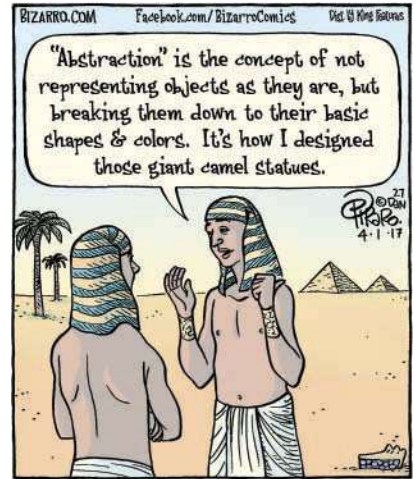
Abstraction A mental model that removes complex details

a computer on one layer, we don't need to be thinking about the details of the other layers. For example, when we are writing a program, we don't have to concern ourselves with how the hardware carries out the instructions. Likewise, when we are running an application program, we don't have to be concerned with how that program was written.

Numerous experiments have shown that a human being can actively manage about seven (plus or minus two, depending on the person) pieces of information in short-term memory at one time. This is called *Miller's Law*, based on the psychologist who first investigated it.¹ Other pieces of information are available to us when we need them, but when we focus on a new piece, something else falls back into secondary status.

This concept is similar to the number of balls a juggler can keep in the air at one time. Human beings can mentally juggle about seven balls at once, and when we pick up a new one, we have to drop another. Seven may seem like a small number, but the key is that each ball can represent an abstraction, or a chunk of information. That is, each ball we are juggling can represent a complex topic as long as we can think about it as one idea.

We rely on abstractions every day of our lives. For example, we don't need to know how a car works to drive one to the store. That is, we don't really need to know how the engine works in detail. We need to know only some basics about how to interact with the car: how the pedals and knobs and steering wheel work. And we don't even have to be thinking about all of those things at the same time. See **FIGURE 1.2**.



Reprinted by permission of Dan Piraro. Visit, <https://bizarro.com/>



FIGURE 1.2 A car engine and the abstraction that allows us to use it

© aospan/Shutterstock; © Syda Productions/Shutterstock

Information hiding

A technique for isolating program pieces by eliminating the ability for one piece to access the information in another

Even if we do know how an engine works, we don't have to think about it while driving. Imagine if, while driving, we had to constantly think about how the spark plugs ignite the fuel that drives the pistons that turn the crankshaft. We'd never get anywhere! A car is much too complicated for us to deal with all at once. All the technical details would be too many balls to juggle at the same time. But once we've abstracted the car down to the way we interact with it, we can deal with it as one entity. The irrelevant details are ignored, at least for the moment.

Information hiding is a concept related to abstraction. A computer programmer often tries to eliminate the need or ability of one part of a program to access information located in another part. This technique keeps the pieces of the program isolated from each other, which reduces errors and makes each piece easier to understand. Abstraction focuses on the external view—the way something behaves and the way we interact with it. Information hiding is a design feature that gives rise to the abstractions that make something easier to work with. Information hiding and abstraction are two sides of the same coin.

Abstract art, as the term implies, is another example of abstraction. An abstract painting represents something but doesn't get bogged down in the details of reality. Consider the painting shown in [FIGURE 1.3](#), entitled *Nude Descending a Staircase*. You can see only the basic hint of the woman and the staircase, because the artist is not interested in the details of exactly how the woman or the staircase looks. Those details are irrelevant to the effect the artist is trying to create. In fact, the realistic details would get in the way of the issues that the artist thinks are important.

Abstraction is the key to computing. The layers of a computing system embody the idea of abstraction. And abstractions keep appearing within individual layers in various ways as well. In fact, abstraction can be seen throughout the entire evolution of computing systems, which we explore in the next section.



FIGURE 1.3 Marcel Duchamp discussing his abstract painting *Nude Descending a Staircase*

© CBS/Landov

1.2 The History of Computing

The historical foundation of computing goes a long way toward explaining why computing systems today are designed as they are. Think of this section as a story whose characters and events have led to the place we are now and form the foundation of the exciting future to come. We examine the history of computing hardware and software separately because each has its own impact on how computing systems evolved into the layered model we use as the outline for this book.

This history is written as a narrative, with no intent to formally define the concepts discussed. In subsequent chapters, we return to these concepts and explore them in more detail.

A Brief History of Computing Hardware

The devices that assist humans in various forms of computation have their roots in the ancient past and have continued to evolve until the present day. Let's take a brief tour through the history of computing hardware.

Early History

Many people believe that Stonehenge, the famous collection of rock monoliths in Great Britain, is an early form of a calendar or astrological calculator. The *abacus*, which appeared in the sixteenth century BC, was developed as an instrument to record numeric values and on which a human can perform basic arithmetic.

In the middle of the seventeenth century, Blaise Pascal, a French mathematician, built and sold gear-driven mechanical machines, which performed whole-number addition and subtraction. Later in the seventeenth century, a German mathematician, Gottfried Wilhelm von Leibniz, built the first mechanical device designed to do all four whole-number operations: addition, subtraction, multiplication, and division. Unfortunately, the state of mechanical gears and levers at that time was such that the Leibniz machine was not very reliable.

In the late eighteenth century, Joseph Jacquard developed what became known as *Jacquard's loom*, used for weaving cloth. The loom used a series of cards with holes punched in them to specify the use of specific colored thread and therefore dictate the design that was woven into the cloth. Although not a computing device, Jacquard's loom was the first to make use of what later became an important form of input: the punched card.

Beyond all dreams



"Who can foresee the consequences of such an invention? The Analytical Engine weaves algebraic patterns just as the Jacquard loom weaves flowers and leaves. The engine might compose elaborate and scientific pieces of music of any degree of complexity or extent."

—Ada, Countess of Lovelace, 1843²

© Artur Debat/Getty Images; © Alan Dyer/Stocktrek Images/Getty Images

Stonehenge Is Still a Mystical Place

Stonehenge, a Neolithic stone structure that rises majestically out of the Salisbury Plain in England, has fascinated humans for centuries. It is believed that Stonehenge was erected over several centuries beginning in about 2180 BCE. Its purpose is still a mystery, although theories abound. At the summer solstice, the rising sun appears behind one of the main stones, giving the illusion that the sun is balancing on the stone. This has led to the early theory that Stonehenge was a temple. Another theory, first suggested in the middle of the twentieth century, is that Stonehenge could have been

used as an astronomical calendar, marking lunar and solar alignments. Yet a third theory is that

Stonehenge was used to predict eclipses. Later research showed that Stonehenge was also used as a cemetery.³ Human remains, from about 3000 BCE until 2500 BCE when the first large stones were raised, have been found. Regardless of why it was built, there is a mystical quality about the place that defies explanation.



venecacolab/Stock/Thinkstock

It wasn't until the nineteenth century that the next major step was taken in computing, this time by a British mathematician. Charles Babbage designed what he called his *analytical engine*. His design was too complex for him to build with the technology of his day, so it was never implemented. His vision, however, included many of the important components of today's computers. Babbage's design was the first to include a memory so that intermediate values did not have to be reentered. His design also included the input of both numbers and mechanical steps, making use of punched cards similar to those used in Jacquard's loom.

Ada Augusta, Countess of Lovelace, was a romantic figure in the history of computing. Ada, the daughter of Lord Byron (the English poet), was a skilled mathematician. She became interested in Babbage's work on the analytical engine and extended his ideas (as well as correcting some of his errors). Ada is credited with being the first programmer. The concept of the loop—a series of instructions that repeat—is attributed to her. The programming language *Ada*, used largely by the U.S. Department of Defense for many years, is named for her.

During the later part of the nineteenth century and the beginning of the twentieth century, computing advances were made rapidly. William Burroughs produced and sold a mechanical adding machine. Dr. Herman Hollerith developed the first electro-mechanical tabulator, which read information from a punched card. His device revolutionized the census

taken every ten years in the United States. Hollerith later formed a company known today as IBM.

In 1936, a theoretical development took place that had nothing to do with hardware per se but profoundly influenced the field of computer science. Alan M. Turing, another British mathematician, invented an abstract mathematical model called a *Turing machine*, laying the foundation for a major area of computing theory. The most prestigious award given in computer science (equivalent to the Fields Medal in mathematics or a Nobel Prize in other sciences) is the Turing Award, named for Alan Turing. The 2014 movie *The Imitation Game* is based on his life. Analysis of the capabilities of Turing machines is a part of the theoretical studies of all computer science students.

In the mid to late 1930s, work on building a computing machine continued around the world. In 1937, George Stibitz constructed a 1-bit binary adder, a device that adds binary digits, using relays (see Chapter 4). Later that year, Claude E. Shannon published a paper about implementing symbolic logic using relays. In 1938, Konrad Zuse built the first mechanical binary programmable computer. A biography of Konrad Zuse is presented in Chapter 6.

By the outbreak of World War II, several general-purpose computers were under design and construction. In London in 1943, Thomas Flowers built the Colossus, shown in [FIGURE 1.4](#) and considered by many to be the first all-programmable electronic digital computer. In 1944, the IBM Automatic Sequence Controlled Calculator was given to Harvard; it was subsequently known as the *Harvard Mark I*. The ENIAC, pictured in [FIGURE 1.5](#), was unveiled in 1946. John von Neumann, who had served as a consultant on the ENIAC project, started work on another machine known as *EDVAC*, which was completed in 1950. In 1951, the first commercial computer, UNIVAC I, was delivered to the U.S. Bureau of the Census. The UNIVAC I was the first computer used to predict the outcome of a presidential election.⁴

The early history that began with the abacus ended with the delivery of the UNIVAC I. With the building of that machine, the dream of a device that could rapidly manipulate numbers was realized. Some experts predicted at that time that a small number of computers would be able

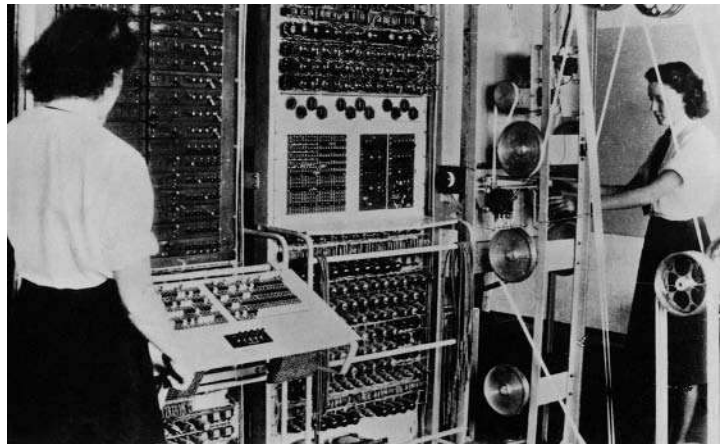


FIGURE 1.4 The Colossus, the first all-programmable digital computer

© Pictorial Press Ltd/Alamy Stock Photo Images.

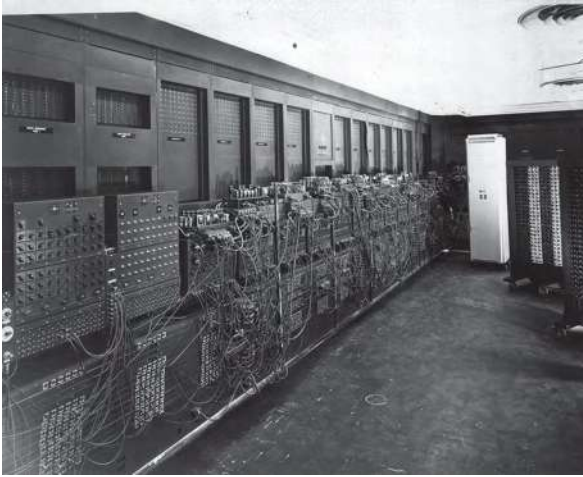


FIGURE 1.5 The ENIAC, a World War II-era computer
Courtesy of U.S. Army.

to handle the computational needs of mankind. What they didn't realize was that the ability to perform fast calculations on large amounts of data would radically change the very nature of fields such as mathematics, physics, engineering, and economics. That is, computers made those experts' assessments of what needed to be calculated entirely invalid.⁵

After 1951, the story becomes one of the ever-expanding use of computers to solve problems in all areas. From that point, the search has focused not only on building faster, bigger devices, but also on developing tools that allow us to use these devices more productively.

© Artur Debat/Getty Images, © Alan Dyer/Stocktrek Images/Getty Images

Counting Precedes Writing

Before humans used writing to count objects, they used three-dimensional tokens of various kinds. For example, around 7500 BCE, farmers made counters of clay in a dozen shapes to help keep track of their goods. A cone stood for a small measure of grain, a sphere for a large measure of grain, and a cylinder for an animal. Four small measures of grain were represented by four cones. Approximately 8000 of these tokens have been found from Palestine, Anatolia, Syria, Mesopotamia, and Iran.

Approximately 3500 BCE, after the rise of the city-states, administrators started using clay balls as envelopes to hold the tokens. Some of these envelopes bore impressions of the tokens they contained. The next step occurred between 3300 and 3200 BCE, when record keepers started just using the impression of the tokens on clay balls, dispensing with the tokens themselves.

Thus it took approximately 4000 years to reduce three-dimensional tokens to written signs.

Around 3100 BCE, styluses were used to draw the tokens rather than impressing the tokens on the tables. This change led to the breaking of the one-to-one correspondence between symbol and object. Ten jars of oil were represented by a jar of oil and a symbol for ten. New signs were not created to express abstract numbers, but old signs took on new meaning. For example, the cone sign, formerly representing a small measure of grain, became the symbol for "1," and the sphere (a large measure of grain) came to mean "10." Now 33 jars of oil could be represented by $10 + 10 + 10 + 1 + 1 + 1$ and the symbol for "oil."

Once abstract numerals were created, the signs for goods and the signs for numbers could evolve in different ways. Thus writing was derived from counting.⁶

The history of computing hardware from this point on is categorized into several “generations” based on the technology they employed.

First Generation (1951–1959)

Commercial computers in the first generation (from approximately 1951 to 1959) were built using *vacuum tubes* to store information. A vacuum tube, shown in [FIGURE 1.6](#), generated a great deal of heat and was not very reliable. The machines that used them required heavy-duty air conditioning and frequent maintenance. They also required large, specially built rooms.

The primary memory device of this first generation of computers was a *magnetic drum* that rotated under a read/write head. When the memory cell being accessed rotated under the read/write head, the data was written to or read from that place.

The input device used by these computers was a card reader that read the holes punched in an IBM card (a descendant of the Hollerith card). The output device was either a punched card or a line printer. By the end of this generation, *magnetic tape drives* had been developed that were much faster than card readers. Magnetic tapes are sequential storage devices, meaning that the data on the tape must be accessed one after another in a linear fashion.

Storage devices external to the computer memory are called *auxiliary storage devices*. The magnetic tape was the first of these devices. Collectively, input devices, output devices, and auxiliary storage devices became known as *peripheral devices*.

Second Generation (1959–1965)

The advent of the *transistor* (for which John Bardeen, Walter H. Brattain, and William B. Shockley won a Nobel Prize) ushered in the second generation of commercial computers. The transistor replaced the vacuum tube as the main component in the hardware. The transistor, as shown in [FIGURE 1.7](#), was smaller, faster, more durable, and cheaper.

The second generation also witnessed the advent of immediate-access memory. When accessing information from a drum, the CPU had to wait for the proper place to rotate under the read/write head. The second generation used memory made from *magnetic cores*, tiny doughnut-shaped devices, each capable of storing one bit of information. These cores were strung together with wires to form cells, and cells were combined into a memory unit. Because the device was motionless and was accessed electronically, information was available instantly.



FIGURE 1.6 A vacuum tube
© SPbPhoto/Shutterstock

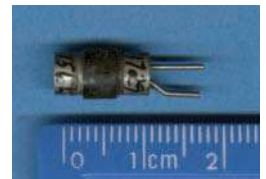


FIGURE 1.7 A transistor, which replaced the vacuum tube
Courtesy of Dr. Andrew Wylie.

© Artur Debat/Getty Images; © Alan Dyer/Stocktrek Images/Getty Images

Ada Lovelace, the First Programmer⁷

On December 10, 1815, a daughter—Augusta Ada Byron—was born to Anna Isabella (Annabella) Byron and George Gordon, Lord Byron. At that time in England, Byron’s fame derived not only from his poetry but also from his wild and scandalous behavior. The marriage was strained from the beginning, and Annabella left Byron shortly after Ada’s birth. By April of 1816, the two had separated and Byron left England, never to return. Throughout the rest of his life he regretted that he was unable to see his daughter. Before he died in Greece, at age 36, he exclaimed,

*Oh my poor dear child! My dear Ada!
My God, could I but have seen her!*

Annabella gave Ada her first instruction in mathematics, and it soon became clear that Ada was gifted in the subject. Ada received further training from Augustus DeMorgan, today famous for one of the basic theorems of Boolean algebra. By age eight, Ada had demonstrated an interest in mechanical devices and was building detailed model boats.

When she was 18, Ada visited the Mechanics Institute to hear Dr. Dionysius Lardner’s lectures on the *Difference Engine*, a mechanical calculating machine being built by Charles Babbage. She became so interested in the device that she arranged to be introduced to Babbage. It was said that, upon seeing Babbage’s machine, Ada was the only person in the room to understand immediately how it worked and to recognize its significance. Ada and Charles Babbage became lifelong friends. She worked with him, helping to document his designs, translating writings about his work, and developing

programs for his machines. Ada today is recognized as the first computer programmer in history.

When Babbage designed his Analytical Engine, Ada saw that it could go beyond arithmetic computations and become a general manipulator of symbols, thus having far-reaching capabilities. She even suggested that such a device eventually could be programmed with rules of harmony and composition so that it could produce “scientific” music. In effect, Ada foresaw the field of artificial intelligence more than 150 years ago.

In 1842, Babbage gave a series of lectures in Turin, Italy, on his Analytical Engine. One of the attendees was Luigi Menabrea, who was so impressed that he wrote an account of Babbage’s lectures. At age 27, Ada decided to translate the account into English, with the intent to add a few of her own notes about the machine. In the end, her notes were twice as long as the original material, and the document, “The Sketch of the Analytical Engine,” became the definitive work on the subject.

It is obvious from Ada’s letters that her “notes” were entirely her own and that Babbage was acting as a sometimes unappreciated editor. At one point, Ada wrote to him,

I am much annoyed at your having altered my Note. You know I am always willing to make any required alterations myself, but that I cannot endure another person to meddle with my sentences.



© Artur Debat/Getty Images; © Alan Dyer/Stocktrek Images/Getty Images

Ada Lovelace (continued)

Ada gained the title “Countess of Lovelace” when she married Lord William Lovelace. The couple had three children, whose upbringing was left to Ada’s mother while Ada pursued her work in mathematics. Her husband was supportive of her work, but for a woman of that day such behavior was considered almost as scandalous as some of her father’s exploits.

Ada died in 1852, just one year before a working Difference Engine was built in Sweden from one of Babbage’s designs. Like her father, Ada lived only to age 36, and even though they led very different lives, she undoubtedly admired him and took inspiration from his unconventional and rebellious nature. In the end, Ada asked to be buried beside him at the family’s estate.

The *magnetic disk*, a new auxiliary storage device, was also developed during the second computer hardware generation. The magnetic disk is faster than magnetic tape because each data item can be accessed directly by referring to its location on the disk. Unlike a tape, which cannot access a piece of data without accessing everything on the tape that comes before it, a disk is organized so that each piece of data has its own location identifier, called an *address*. The read/write heads of a magnetic disk can be sent directly to the specific location on the disk where the desired information is stored.

Third Generation (1965–1971)

In the second generation, transistors and other components for the computer were assembled by hand on printed *circuit boards*. The third generation was characterized by *integrated circuits* (ICs), solid pieces of silicon that contained the transistors, other components, and their connections. Integrated circuits were much smaller, cheaper, faster, and more reliable than printed circuit boards. Gordon Moore, one of the co-founders of Intel, noted that from the time of the invention of the IC, the number of circuits that could be placed on a single integrated circuit was doubling each year. This observation became known as *Moore’s law*.⁸

Transistors also were used for memory construction, where each transistor represented one bit of information. Integrated-circuit technology allowed memory boards to be built using transistors. Auxiliary storage devices were still needed because transistor memory was *volatile*; that is, the information went away when the power was turned off.

The *terminal*, an input/output device with a keyboard and screen, was introduced during this generation. The keyboard gave the user direct access to the computer, and the screen provided an immediate response.

Fourth Generation (1971–?)

Large-scale integration characterizes the fourth generation. From several thousand transistors on a silicon chip in the early 1970s, we had moved to a whole microcomputer on a chip by the middle of this decade. Main memory devices are still made almost exclusively out of chip technology. Over the previous 40 years, each generation of computer hardware had become more powerful in a smaller package at lower cost. Moore's law was modified to say that chip density was doubling every 18 months.

By the late 1970s, the phrase *personal computer* (PC) had entered the vocabulary. Microcomputers had become so cheap that almost anyone could have one, and a generation of kids grew up playing Pac-Man.

The fourth generation found some new names entering the commercial market. Apple, Tandy/Radio Shack, Atari, Commodore, and Sun joined the big companies of earlier generations—IBM, Remington Rand, NCR, DEC (Digital Equipment Corporation), Hewlett-Packard, Control Data, and Burroughs. The best-known success story of the personal computer revolution is that of Apple. Steve Wozniak, an engineer, and Steve Jobs, a high school student, created a personal computer kit and marketed it out of a garage. This was the beginning of Apple Computer, a multibillion-dollar company.

The IBM PC was introduced in 1981 and was soon followed by compatible machines manufactured by many other companies. For example, Dell and Compaq were successful in making PCs that were compatible with IBM PCs. Apple introduced its very popular Macintosh microcomputer line in 1984.

In the mid-1980s, larger, more powerful machines were created; they were referred to as *workstations*. Workstations were generally meant for business, not personal, use. The idea was for each employee to have his or her own workstation on the desktop. These workstations were connected by cables, or *networked*, so that they could interact with one another. Workstations were made more powerful by the introduction of the RISC (reduced-instruction-set computer) architecture. Each computer was designed to understand a set of instructions, called its *machine language*. Conventional machines such as the IBM 370/168 had an instruction set containing more than 200 instructions. Instructions were fast and memory access was slow, so specialized instructions made sense. As memory access got increasingly

?

Scientists build first nanotube computer

Scientists are examining the possibility of using carbon nanotubes, seamless cylinders of ultrapure carbon, as a basis for future computers. As electrical conduction speeds of conventional silicon transistors begin to reach the limits of the technology, the search is on for replacements that are faster than silicon.

faster, using a reduced set of instructions became attractive. Sun Microsystems introduced a workstation with a RISC chip in 1987. Its enduring popularity proved the feasibility of the RISC chip. These workstations were often called *UNIX workstations* because they used the UNIX operating system.

Because computers are still being made using circuit boards, we cannot mark the end of this generation. However, several things have occurred that so dramatically affected how we use machines that they certainly have ushered in a new era. Moore's law was once again restated in the following form: "Computers will either double in power at the same price or halve in cost for the same power every 18 months."⁹

Parallel Computing

Although computers that use a single primary processing unit continue to flourish, radically new machine architectures began appearing in the late 1980s. Computers that use these *parallel architectures* rely on a set of interconnected central processing units.

One class of parallel machines is organized so that the processors all share the same memory unit. In another class of machines, each central processor has its own local memory and communicates with the others over a very fast internal network.

Parallel architectures offer several ways to increase the speed of execution. For example, a given step in a program can be separated into multiple pieces, and those pieces can be executed simultaneously on several individual processors. These machines are called *SIMD* (single-instruction, multiple-data-stream) computers. A second class of machines can work on different parts of a program simultaneously. These machines are called *MIMD* (multiple-instruction, multiple-data-stream) computers.

The potential of hundreds or even thousands of processors combined in one machine is enormous, and the challenge of programming for such machines is equally daunting. Software designed for parallel machines is different from software designed for sequential machines. Programmers have to rethink the ways in which they approach problem solving and programming to exploit parallelism.

Networking

In the 1980s, the concept of a large machine with many users gave way to a network of smaller machines connected so that they can share resources such as printers, software, and data. *Ethernet*, invented by Robert Metcalfe and David Boggs in 1973, used a cheap coaxial cable to connect the

From a garage to the Fortune 500

Boyhood friends Steve Jobs and Steve Wozniak sold their Volkswagen van and programmable calculator, respectively, to raise the money to finance their new computer company. Their first sale was 50 Apple I's, the computer that they had designed and built in a garage. In six short years Apple was listed in the Fortune 500.

**Jobs and Wozniak can't give it away**

"So we went to Atari and said, 'Hey, we've got this amazing thing, even built with some of your parts, and what do you think about funding us? Or we'll give it to you. We just want to do it. Pay our salary, we'll come work for you.' And they said, 'No.' So then we went to Hewlett-Packard, and they said, 'Hey, we don't need you. You haven't got through college yet.'"¹⁰

machines and a set of protocols to allow the machines to communicate with one another. By 1979, DEC, Intel, and Xerox joined to establish Ethernet as a standard.

Workstations were designed for networking, but networking personal computers didn't become practical until a more advanced Intel chip was introduced in 1985. By 1989, Novell's Netware connected PCs together with a *file server*, a computer with generous mass storage and good input/output capability. Placing data and office automation software on the server rather than each PC having its own copy allowed for a measure of central control while giving each machine a measure of autonomy. Workstations or personal computers networked together became known as *LANs* (local area networks).

The *Internet* as we know it today is descended from the ARPANET, a government-sponsored network begun in the late 1960s, which originally consisted of 11 nodes concentrated mainly in the Los Angeles and Boston areas. Like ARPANET and LANs, the Internet uses *packet switching*, a way for messages to share lines. The Internet, however, is made up of many different networks across the world that communicate by using a common protocol, TCP/IP (Transmission Control Protocol/Internet Protocol).

Paul E. Ceruzzi, in *A History of Modern Computing*, comments on the relationship between Ethernet and the Internet:

If the Internet of the 1990s became the Information Superhighway, then Ethernet became the equally important network of local roads to feed it. As a descendent of ARPA research, the global networks we now call the Internet came into existence before the local Ethernet was invented at Xerox. But Ethernet transformed the nature of office and personal computing before the Internet had a significant effect.¹¹

Cloud Computing

Some of the most recent changes in the overall management and use of computing hardware are based on the increasing reliance on *cloud computing*, which is the use of computer resources on the Internet instead of relying on devices at your physical location. The computing hardware is somewhere "in the cloud" instead of on your desktop or even in your building.

Hardware problems make computing difficult, especially for businesses and other large-scale endeavors. People trying to solve problems don't want to have additional problems related to the maintenance of computers and the need to upgrade to more advanced technology as it becomes available.

As networking became more available, businesses would increasingly rely on data centers to support their computing efforts. A *data center* is generally a third-party solution—a separate business providing computing hardware that another business would use. The personnel at the data center set up and configure the machines needed by the business.

The use of a data center offloaded a big part of the challenges of managing the necessary computing infrastructure, but the process could still be painful because of the communication necessary between the business and the data center. It would often take several days to set up a new computer (a *server*) needed by the business.

Eventually, the idea of a data center evolved into the concept of cloud computing, in which a business could “spin up” a new server in a matter of minutes using some commands through a web interface. The process is so much more streamlined now that many businesses don’t even consider owning and managing their own computing hardware.

Cloud computing is discussed further in Chapter 15.

A Brief History of Computing Software

The hardware of a computer does nothing until it is directed to do so by the computer’s software. The manner in which software evolved is crucial to understanding how software works in a modern computing system.

First-Generation Software (1951–1959)

The first programs were written using *machine language*, the instructions built into the electrical circuitry of a particular computer. Even the small task of adding two numbers together used three instructions written in *binary* (1s and 0s), and the programmer had to remember which combination of binary digits meant what. Programmers using machine language had to be very good with numbers and very detail oriented. It’s not surprising that the first programmers were mathematicians and engineers. It’s also not surprising that programming in machine language was both time-consuming and prone to errors.

Because writing in machine code is so tedious, some programmers took the time to develop tools to help with the programming process. Programmers began writing programs in *assembly language*, which used mnemonic codes to represent each machine-language instruction.

Because every program that is executed on a computer eventually must be in the form of the computer’s machine language, the developers of assembly language also created software *translators* to translate programs written in assembly language into machine code. A program

Computer History Museum

The first computer museum opened in 1979, located in the corporate headquarters of Digital Equipment Corporation (DEC) in Marlborough, Massachusetts. After several incarnations, in 2005 the Computer History Museum moved into a permanent home in Mountain View, California, in the heart of Silicon Valley.¹²

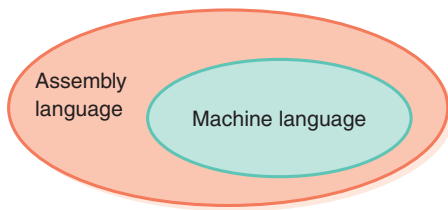


FIGURE 1.8 Language layers in the first generation

called an *assembler* reads each of the program's instructions in mnemonic form and translates it into the machine-language equivalent. These mnemonics are abbreviated and sometimes difficult to read, but they are much easier to use than long strings of binary digits. Assembly language was the first step toward the languages we use today to program computers.

The programmers who wrote these tools to make programming easier for others were the first *systems programmers*. So, even in first-generation software, there was the division between those programmers who wrote tools and those programmers who used the tools. The assembly language acted as a buffer between the programmer and the machine hardware. See [FIGURE 1.8](#). Sometimes, when efficient code is essential, programs today may be written in assembly language. Chapter 6 explores an example of machine code and a corresponding assembly language in detail.

Second-Generation Software (1959–1965)

As hardware became more powerful, more powerful tools were needed to use it effectively. Assembly languages certainly presented a step in the right direction, but the programmer still was forced to think in terms of individual machine instructions. The second generation saw more powerful languages developed. These *high-level languages* allowed the programmer to write instructions using more English-like statements.

Two of the languages developed during the second generation include FORTRAN (a language designed for numerical applications) and COBOL (a language designed for business applications). FORTRAN and COBOL developed quite differently. FORTRAN started out as a simple language and grew as additional features were added to it over the years. In contrast, COBOL was designed first and then implemented. It has changed little over time.

Another language that was designed during this period is Lisp. Lisp differs markedly from FORTRAN and COBOL and was not widely accepted. It was used mainly in artificial intelligence applications and research. A dialect of Lisp called *Scheme* is one of the languages used today for programming modern artificial intelligence systems.

The introduction of high-level languages provided a vehicle for running the same program on more than one computer. As with assembly

language, a program written in a high-level language has to be translated into machine instructions to be executed. Such a translator is called a *compiler*, and it also checks to ensure that the syntax of the high-level language is being followed correctly. A program written in FORTRAN or COBOL wasn't tied to a particular type of computer. It could run on any machine that had an appropriate compiler.

At the end of the second generation, the role of the systems programmer was becoming more well-defined. Systems programmers wrote tools like assemblers and compilers; those people who used the tools to write programs were called *applications programmers*. The applications programmer was becoming even more insulated from the computer hardware as the software surrounding the hardware became more sophisticated. See [FIGURE 1.9](#).

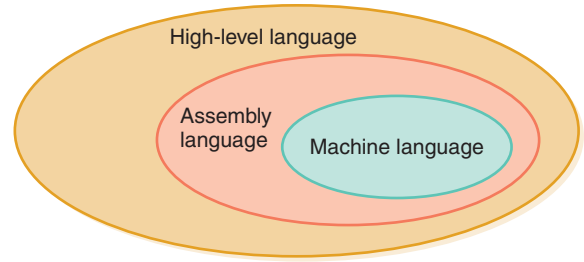


FIGURE 1.9 Language layers in the second generation

Third-Generation Software (1965–1971)

During the third generation of commercial computers, it became apparent that the human was slowing down the computing process. Computers were sitting idle while waiting for the computer operator to prepare the next job. The solution was to put the computer resources under the control of the computer—that is, to write a program that would determine which programs were run when. This kind of program was the first *operating system*.

During the first two computer software generations, utility programs had been written to handle often-needed tasks. *Loaders* loaded programs into memory and *linkers* linked pieces of large programs together. In the third generation, these utility programs were refined and put under the direction of the operating system. This group of utility programs, the operating system, and the language translators (assemblers and compilers) became known as *systems software*.

The introduction of computer terminals as input/output devices gave users ready access to computers, and advances in systems software gave machines the ability to work much faster. However, inputting and outputting data from keyboards and screens was a slow process, much slower than carrying out instructions in memory. The problem was how to make better use of the machine's greater capabilities and speed. The solution was *time sharing*—many different users, each at a terminal, communicating

with a single computer all at the same time. Controlling this process was an operating system that organized and scheduled the different jobs.

For the user, time sharing is much like having his or her own machine. Each user is assigned a small slice of central processing time and then is put on hold while another user is serviced. Users generally aren't even aware that there are other users. However, if too many people try to use the system at the same time, there can be a noticeable wait for a job to be completed.

As part of the third generation, general-purpose application programs also were being written. One example was the Statistical Package for the Social Sciences (SPSS), which was written in FORTRAN. SPSS had a special language that allowed the user, who was often not a programmer, to describe some data and the statistics to be computed on that data.

At the beginning of the computer era, the computer user and the programmer were the same person. By the end of the first generation, programmers had emerged who wrote tools for other programmers to use, giving rise to the distinction between systems programmers and applications programmers. However, the programmer was still the user. In the third generation, systems programmers were writing software for nonprogrammers to use. For the first time, there were computer users who were not programmers in the traditional sense.

The separation between the user and the hardware was growing wider. The hardware had become an even smaller part of the picture. A computer system—a combination of hardware, software, and the data managed by them—had emerged. See [FIGURE 1.10](#). Occasionally programmers

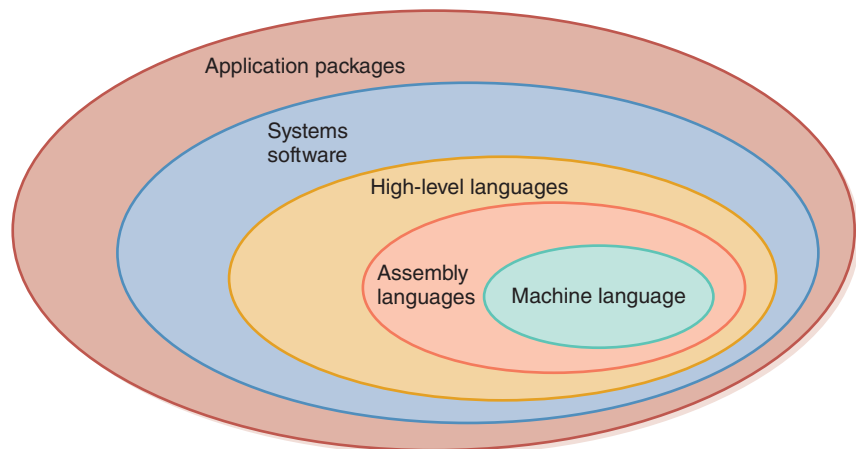


FIGURE 1.10 The layers of software surrounding the hardware continue to grow

still needed to access the computer at lower levels, but the tools available at higher levels changed the situation greatly.

Fourth Generation (1971–1989)

The 1970s saw the introduction of better programming techniques called *structured programming*, a logical, disciplined approach to programming. The languages Pascal and Modula-2 were built on the principles of structured programming. BASIC, a language introduced for third-generation machines, was refined and upgraded to more structured versions. C, a language that allows the user to intersperse assembly-language statements in a high-level program, was also introduced. C++, a structured language that allows the user access to low-level statements as well, became the language of choice in the industry.

Better and more powerful operating systems were being developed, too. UNIX, developed at AT&T™ as a research tool, has become standard in many university settings. PC-DOS, developed for the IBM PC, and MS-DOS, developed for PC compatibles, became standards for personal computers. Apple capitalized on research done at Xerox PARC by incorporating a mouse and point-and-click graphical interface into the operating system for the Macintosh, which ushered in an important change to computer–user interaction on personal computers.

High-quality, reasonably priced applications software packages became available at neighborhood stores. These programs allow the user with no computer experience to perform a specific task. Three types of application software introduced during this period are still crucial to computer use today: *spreadsheets*, *word processors*, and *database management systems*. Lotus 1-2-3 was the first commercially successful spreadsheet that allowed a novice user to enter and analyze all kinds of data. WordPerfect was one of the first word processors, and dBase IV was a system that let the user store, organize, and retrieve data.

Fifth Generation (1990–Present)

The fifth generation is notable for three major events: the rise of Microsoft® as a dominant player in computer software, object-oriented design and programming, and the World Wide Web.

Microsoft’s Windows operating system emerged as a major force in the PC market during this period. Although WordPerfect continued to improve, Microsoft Word became the most used word processing program. In the mid-1990s, word processors, spreadsheet programs, database

From computers to books

Former Microsoft executive John Wood left his job to start a nonprofit that builds schools and libraries in developing countries. He said, “Education is the ticket out of poverty, and it produces better family health and better treatment of women. Every day, 250 million kids worldwide wake up with no school to go to. Two-thirds of them are girls.” By 2018, Room to Read had distributed 20.6 million books and trained more than 10,000 teachers.^{13,14,26}

programs, and other application programs were bundled together into super packages called *office suites*.

Object-oriented design became the design of choice for large programming projects. Whereas structured design is based on a hierarchy of tasks, object-oriented design is based on a hierarchy of data objects. Java™, a language designed by Sun Microsystems for object-oriented programming, began to rival C++.

In 1990, Tim Berners-Lee, a British researcher at the CERN physics lab in Geneva, Switzerland, created a set of technical rules for what he hoped would be a universal Internet document center called the *World Wide Web*. Along with these rules, he created HTML, a language for formatting documents, and a rudimentary, text-only *browser*, a program that allows a user to access information from websites worldwide. In 1993, Marc Andreessen and Eric Bina released Mosaic, the first graphics-capable browser. To quote *Newsweek*: “Mosaic just may have been the most important computer application ever.”¹⁶

At this point, there were two giants in the browser market: Netscape Navigator (derived from Mosaic) and Microsoft’s Internet Explorer (IE). Microsoft bundled IE with its Windows operating system, which made IE the winner in the browser wars. This bundling led to a monopoly lawsuit filed by the U.S. government, the 2001 settlement of which required Microsoft to be more open with its competitors. Netscape’s future became uncertain after America Online purchased it in 1998, and it was eventually discontinued. Microsoft eventually replaced Internet Explorer with a browser called *Edge*.

Firefox, a web browser that retained some of the flavor of Mosaic, was released in 2004. Around the same time, Apple released its Safari browser. In 2008, Google announced its browser called *Chrome*. All of these now claim their share of the browser market.

Although the Internet had been around for decades, the World Wide Web made it easy to use the Internet to share information around the world. User-generated and user-edited content became the norm. Online blogging allowed anyone to become an author or a critic. Social networking has revolutionized how we interact with other people. Websites such as the online encyclopedia Wikipedia provide rich content that anyone can add to and edit.

The fifth generation must be characterized most of all by the changing profile of the user. The first user was the programmer who wrote programs to solve specific problems—his or her own or someone else’s. Then the systems programmer emerged, who wrote more and more complex tools for other programmers. By the early 1970s, applications programmers

were using these complex tools to write applications programs for non-programmers to use. With the advent of the personal computer, computer games, educational programs, and user-friendly software packages, many people became computer users. With the birth and expansion of the World Wide Web, web surfing has become the recreation of choice, so even more people have become computer users. The user is a first-grade child learning to read, a teenager downloading music, a college student writing a paper, a homemaker planning a budget, and a banker looking up a customer's loan record. The user is all of us.

In our brief history of hardware and software, we have focused our attention on traditional computers and computing systems. Paralleling this history is the growing use of integrated circuits, or *chips*, to run or regulate everything from toasters to cars to intensive care monitors to satellites. Such computing technology is called an *embedded system*. Although these chips are not actually computers in the sense that we are going to study in this book, they are certainly a product of the technology revolution of the past 55 years.

Predictions

We end this brief history of computing with a few predictions about computers that didn't come true:¹⁶⁻¹⁸

"I think there is a world market for maybe five computers." — Thomas Watson, chair of IBM, 1943.

"Where . . . the ENIAC is equipped with 18,000 vacuum tubes and weighs 30 tons, computers in the future may have only 1,000 vacuum tubes and weigh only 1.5 tons." —*Popular Mechanics*, 1949.

"I have traveled the length and breadth of this country and talked with the best people, and I can assure you that data processing is a fad that won't last out the year." —The editor in charge of business books for Prentice Hall, 1957.

"But what . . . is it good for?" —Engineer at the Advanced Computing Systems division of IBM, commenting on the microchip, 1968.

"There is no reason anyone would want a computer in their home." —Ken Olsen, president, chairman, and founder of Digital Equipment Corporation, 1977.

“\$100 million is way too much to pay for Microsoft.” —IBM, 1982.

“I predict the Internet . . . will go spectacularly supernova and in 1996 catastrophically collapse.” —Bob Metcalfe, 3Com founder and inventor, 1995.

“Folks, the Mac platform is through—totally.” —John C. Dvorak, *PC Magazine*, 1998.

1.3 Computing as a Tool and a Discipline

In the previous section on the history of computer software, we highlighted the ever-changing role of the user. At the end of the first generation, users were split into two groups: systems programmers, who developed tools to make programming easier, and applications programmers, who used those tools. Later, applications programmers built large domain-specific programs such as statistical packages, word processors, spreadsheets, intelligent browsers, virtual environments, and medical diagnosis applications on top of the traditional language tools. These application programs were, in turn, used by practitioners with no computer background.

So who is using the computer as a tool? Everyone, except for those people who are creating the tools for others. For these toolmakers, either computing is a discipline (low-level tools) or the discipline of computing has made their tools possible (applications built upon applications).

A *discipline* is defined as a field of study. Peter Denning defines the discipline of computer science as “the body of knowledge and practices used by computing professionals in their work. . . . This discipline is also called computer science and engineering, computing, and informatics.”¹⁹ He continues, “The body of knowledge of computing is frequently described as the systematic study of algorithmic processes that describe and transform information: their theory, analysis, design, efficiency, implementation, and application. The fundamental question underlying all of computing is, *What can be (efficiently) automated?*”

Denning states that each practitioner must be skilled in four areas:

- *Algorithmic thinking*, in which one is able to express problems in terms of step-by-step procedures to solve them
- *Representation*, in which one is able to store data in a way that it can be processed efficiently
- *Programming*, in which one is able to combine algorithmic thinking and representation into computer software
- *Design*, in which the software serves a useful purpose

1.3 Computing as a Tool and a Discipline

A debate has long raged about whether computing is a mathematical discipline, a scientific discipline, or an engineering discipline. The reality is that it has aspects of all three. Computing certainly has strong roots in mathematical logic. The theorems of Turing tell us that certain problems cannot be solved, Boolean algebra describes computer circuits, and numerical analysis plays an important role in scientific computing. Scientific disciplines apply a rigorous, analytical process for testing hypotheses. The natural sciences (such as biology, physics, and chemistry) exist to “fill in the instruction book that God forgot to leave us.”²⁰ But the scientific method can be applied to any organized investigation. Computer scientists test hypotheses related to various aspects of computing. When we design and build larger and more complex computing systems, we use techniques from engineering.

The Big Ideas of Computing

The AP Computer Science Principles curriculum lists seven big ideas that are essential to understanding computing.²¹ They are summarized in

TABLE 1.1

When you think about creativity, you might think about artists. You might not think of a computer as a device that promotes creativity, but it

TABLE

1.1 Big Ideas in Computing

Creativity	Computing has changed the way humans can be creative, including the creation of video, animation, infographics, and audio.
Abstraction	Abstraction is the mechanism used to model the world and facilitate communication among humans and machines.
Data and information	Crucial to computing is the management and interpretation of data and information, leading to the creation of knowledge.
Algorithms	Algorithms allow us to develop and express solutions to problems.
Programming	Of course, computing involves programming, which allows us to implement the solutions to problems.
The Internet	Not only does the Internet provide a mechanism for communicating and sharing resources among people and machines, it also has become the means by which computing is accomplished in many situations.
Global impact	Computing enables innovation, which has potential benefits and harmful effects in various contexts.



Computers go to college

The first departments of computer science were established in 1962 at Purdue and Stanford Universities. The first PhD in computer science was awarded by the University of Pennsylvania in 1965. The first curriculum effort in computer science was published in 1968.²²

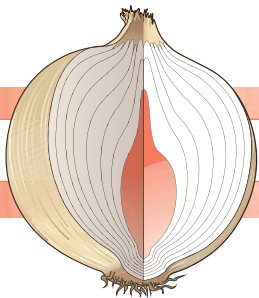
certainly is. The artifacts created using a computer are still the result of a human being's ingenuity. Presentations, images, audio, video, web pages, and programs are all brought about by human acts of creation. We use software tools to do so, just as a sculptor uses a chisel, but the end product is created by the human's efforts, not the tool.

Even the process of writing a program, often considered a core computing activity, is a creative effort. The purpose of a program depends on the goals of the programmer and the end user (the person who runs the program). A program might be created to satisfy personal curiosity to solve a world-changing problem, or it might be used to develop insight into data. Often, the results of running a program can have an effect on a large number of people, and change organizations and even entire societies.

Despite its old-fashioned roots, the process of programming, and the resulting product, does not have to be a stale, boring thing, made only for crunching numbers. Programs may use various forms of input and output, including visual (text, graphics), audible (sound effects, music, human speech), or tactile (touch screens, vibrating controllers, and virtual reality gloves).

The process of creation using a computer involves a variety of techniques and tools, many of which we discuss throughout this text. Some you'll be familiar with; others will likely be new to you. Many involve applying old ideas in new ways.

In this text we explore, at an introductory level, all of these big ideas to varying degrees. This text does not aim to make you a better computer user, although it should undoubtedly have that side effect. Instead, we want you to walk away with a thorough knowledge of how computing systems work, where they are now, and where they may go in the future.



© Artur Debat/Getty Images, © Alan Dyer/Stocktrek Images/Getty Images

SUMMARY

This book is a broad study of computer systems, including the hardware that makes up the devices, the software programs executed by the machine, and the data managed and manipulated by both. Computing systems can be divided into layers, and our organization of this book follows those layers from the inside out.

The history of computing reveals the roots from which modern computing systems grew. This history spans four generations, each characterized

by the components used to build the hardware and the software tools developed to allow the programmer to make more productive use of the hardware. These tools have formed layers of software around the hardware.

Throughout the rest of this book, we examine the different layers that make up a computing system, beginning with the information layer and ending with the communication layer. Our goal is to give you an appreciation and understanding of all aspects of computing systems.

You may go on to study computer science in depth and contribute to the future of computing systems. Or you may go on to be an application specialist within other disciplines, using the computer as a tool. Whatever your future holds, given how prevalent computing systems are, a fundamental understanding of how they work is imperative.



ETHICAL ISSUES

Digital Divide

The term *digital divide* has come to represent the disparity between Information Age haves and have nots. The ICT Development Index (IDI) is based on a set of indicators that measure issues related to information and communication technologies. It allows countries to be compared in terms of their population's access to computers and the Internet, among other tech-related measurements. In 2017, the United States ranked in the middle of the top 30 countries on this scale, with Iceland, South Korea, and Switzerland topping the list.²³

Although this gap is narrowing, it is still of social concern. As groups, rural communities, minority households, low-income families, and people with disabilities do not have the same levels of Internet access as more advantaged people. In educational settings, Web connections and the quantity and quality of computers vary greatly across demographic regions. Programs such as the federally supported E-Rate Program, established in 1996 and funded by fees charged to companies that provide interstate and/or international telecommunications services, respond to these inequalities by providing financial discounts to schools and libraries in need.

In 2005, Nicholas Negroponte, in collaboration with MIT, launched the One

Laptop per Child (OLPC) program. Working from the philosophy that every child—even those in the most remote regions of the world—should have access to a computer, OLPC set out to produce a low-cost laptop for children who otherwise could not afford one. OLPC designed a basic laptop that sold for less than \$200 at a time when the cheapest laptops cost over \$1000. By 2015, more than three million XO laptops had been distributed worldwide.²⁴

The digital divide encompasses an additional challenge that developing nations must face. Without the necessary telecommunication infrastructures to support Internet access, emerging countries are at a serious disadvantage. This is reflected in statistics that show how Internet access varies throughout the world. The ICT Development Index is lowest for countries throughout Africa and the Middle East.

With the advent of smartphones, computer usage and Internet access no longer parallel each other. You no longer need a computer to be an Internet user.

A thought to ponder: Those without Internet access do not know what is happening around the world, and the world has no access to what they are thinking. They are invisible to the rest of the world, and the rest of the world is invisible to them.

KEY TERMS

Abstraction
Computer hardware

Computer software
Computing system

EXERCISES

For Exercises 1–10, choose from the following list of people.

- A. Leibniz
- B. Pascal
- C. Babbage
- D. Lovelace
- E. Hollerith
- F. Byron
- G. Turing
- H. Jacquard

1. What French mathematician built and sold the first gear-driven mechanical machine that did addition and subtraction?
2. Who built the first mechanical machine that did addition, subtraction, multiplication, and division?
3. Who designed the first mechanical machine that included memory?
4. Who was considered the first programmer?
5. Who proposed that a punched card be used for counting the census?
6. Who edited Babbage's work?

7. Who was Ada Lovelace's father?
8. Who would have been mentioned in the book the *Code Breakers*?
9. Who developed the concept of punched holes used in weaving cloth?
10. Who is associated with IBM?

For Exercises 11–23, match the hardware listed to the appropriate generation.

- A. First
 - B. Second
 - C. Third
 - D. Fourth
 - E. Fifth
11. Circuit boards
 12. Transistor
 13. Magnetic core memory
 14. Card input/output
 15. Parallel computing
 16. Magnetic drum
 17. Magnetic tape drives
 18. Integrated circuits
 19. Personal computer
 20. Vacuum tube
 21. Large-scale integration

EXERCISES (CONTINUED)

- 22. Magnetic disk
- 23. Networking

For Exercises 24–38, match the software or software concepts listed to the appropriate generation.

- A. First
 - B. Second
 - C. Third
 - D. Fourth
 - E. Fifth
- 24. Assemblers
 - 25. FORTRAN
 - 26. Operating systems
 - 27. Structured programming
 - 28. Time sharing
 - 29. HTML (for the Web)
 - 30. Loaders
 - 31. Spreadsheets
 - 32. Word processors
 - 33. Lisp
 - 34. PC-DOS
 - 35. Loaders/linkers bundled into an operating system
 - 36. Java
 - 37. SPSS
 - 38. C++

Exercises 39–59 are short-answer questions.

- 39. What do we mean by the statement that “the 1980s and 1990s must be characterized by the changing profile of the *user*”?
- 40. Why was Mosaic important?
- 41. Discuss the browser wars.
- 42. Describe how the Web changed after 2002.
- 43. Of the predictions listed in this chapter on page 25 and 26, which do you consider the biggest error in judgment? Explain.
- 44. Name the four areas in which the practitioner must be skilled.
- 45. Distinguish between computing as a tool and computing as a discipline.
- 46. Is computing a mathematical discipline, a scientific discipline, or an engineering discipline? Explain.
- 47. Distinguish between systems areas and applications areas in computing as a discipline.
- 48. Define the word *abstraction* and relate it to the drawing in Figure 1.2.
- 49. What is cloud computing?
- 50. Define the word *protocol* and explain how it is used in computing.
- 51. Distinguish between machine language and assembly language.
- 52. Distinguish between assembly language and high-level languages.
- 53. FORTRAN and COBOL were two high-level languages defined during the second generation of computer software. Compare and contrast these languages in terms of their history and their purpose.

EXERCISES (CONTINUED)

54. Distinguish between an assembler and a compiler.
55. Distinguish between a systems programmer and an applications programmer.
56. What was the rationale behind the development of operating systems?
57. What constitutes systems software?
58. What do the following pieces of software do?
 - a. Loader
 - b. Linker
 - c. Editor
59. How was the program SPSS different from the programs that came before it?

THOUGHT QUESTIONS

1. Identify five abstractions in your school environment. Indicate which details are hidden by the abstraction and how the abstraction helps manage complexity.
2. Discuss the role of *abstraction* in the history of computer software.
3. Which big ideas in Table 1.1 do you think are the most important? Why?
4. Do you know anyone today who does not have Internet access?

Laying the Groundwork

- 1 The Big Picture

The Information Layer

- 2 Binary Values and Number Systems
- 3 Data Representation

The Hardware Layer

- 4 Gates and Circuits
- 5 Computing Components

The Programming Layer

- 6 Low-Level Programming Languages and Pseudocode
- 7 Problem Solving and Algorithms
- 8 Abstract Data Types and Subprograms
- 9 Object-Oriented Design and High-Level Programming Languages

The Operating Systems Layer

- 10 Operating Systems
- 11 File Systems and Directories

The Applications Layer

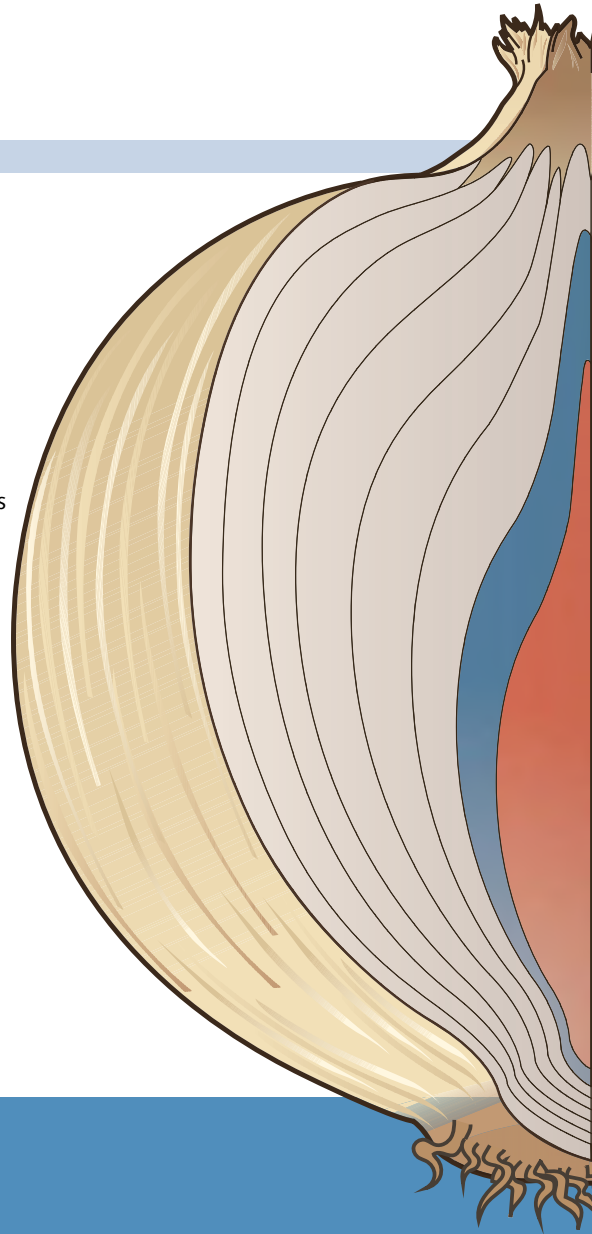
- 12 Information Systems
- 13 Artificial Intelligence
- 14 Simulation, Graphics, Gaming, and Other Applications

The Communications Layer

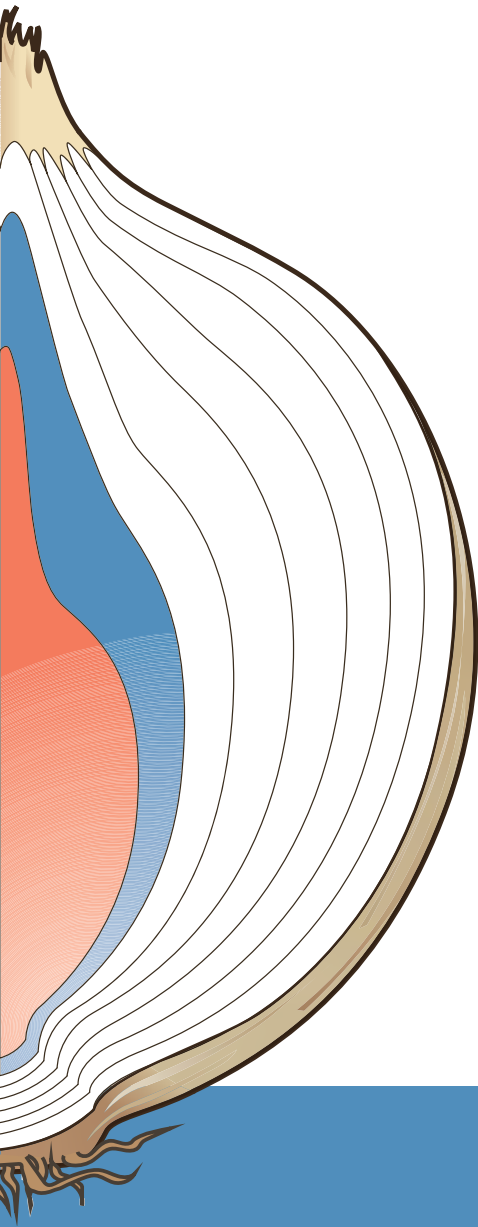
- 15 Networks
- 16 The World Wide Web
- 17 Computer Security

In Conclusion

- 18 Limitations of Computing



THE INFORMATION LAYER



2

BINARY VALUES AND NUMBER SYSTEMS

Now that we've covered some history and common terminology in Chapter 1, our exploration of computing technology can begin in earnest. This chapter describes binary values—the way in which computer hardware represents and manages information. This chapter also puts binary values in the context of all number systems, reminding us of grade school concepts that we now take for granted. You probably already know many of the concepts about binary numbers described in this chapter, but you might not realize that you know them! The rules of all number systems are the same; it's just a matter of going back to those underlying concepts and applying them in a new base. By making sure we have an understanding of binary values, we pave the way to understanding how computing systems use the binary number system to accomplish their tasks.

GOALS

After studying this chapter, you should be able to:

- distinguish among categories of numbers.
- describe positional notation.
- convert numbers in other bases to base 10.
- convert base-10 numbers to numbers in other bases.
- describe the relationship between bases 2, 8, and 16.
- explain the importance to computing of bases that are powers of 2.

Number A unit of an abstract mathematical system subject to the laws of arithmetic

Natural number The number 0 and any number obtained by repeatedly adding 1 to it

Negative number A value less than 0, with a sign opposite to its positive counterpart

Integer A natural number, a negative of a natural number, or zero

Rational number An integer or the quotient of two integers (division by zero excluded)

2.1 Numbers and Computing

Numbers are crucial to computing. In addition to using a computer to execute numeric computations, all types of information that we store and manage using a computer are ultimately stored as numbers. At the lowest level, computers store all information using just the digits 0 and 1. So to begin our exploration of computers, we need to first begin by exploring numbers.

First, let's recall that numbers can be classified into all sorts of categories. There are natural numbers, negative numbers, rational numbers, irrational numbers, and many others that are important in mathematics. Only some of these are crucial to the understanding of computing. Let's review the relevant category definitions briefly.

First, let's define the general concept of a number: A **number** is a unit belonging to an abstract mathematical system and is subject to specified laws of succession, addition, and multiplication. That is, a number is a representation of a value, and certain arithmetic operations can be consistently applied to such values.

Now let's separate numbers into categories. A **natural number** is the number 0 or any number obtained by repeatedly adding 1 to this number. Natural numbers are the ones we use in counting. A **negative number** is less than zero and is opposite in sign to a positive number. An **integer** is any of the natural numbers or any of the negatives of these numbers. A **rational number** is an integer or the quotient of two integers—that is, any value that can be expressed as a fraction.

In this chapter, we focus on natural numbers and the ways that they are represented in various number systems. As part of our discussion, we establish how all number systems relate to each other. In Chapter 3, we examine the computer representation of negative and rational numbers, as well as how we use numbers to represent other forms of data such as characters and images.

Some of the material in this chapter may already be familiar to you. Certainly some of the underlying ideas should be. You probably take for granted some basic principles of numbers and arithmetic because you've become so used to them. Part of our goal in this chapter is to remind you of those underlying principles and to show you that they apply to all number systems. Then the idea that a computer uses binary values—that is, 1s and 0s—to represent information should be less mysterious.

2.2 Positional Notation

How many ones are there in 943? That is, how many actual things does the number 943 represent? Well, in grade school terms, you might say there are

9 hundreds plus 4 tens plus 3 ones. Or, said another way, there are 900 ones plus 40 ones plus 3 ones. So how many ones are there in 754? 700 ones plus 50 ones plus 4 ones. Right? Well, maybe. The answer depends on the *base* of the number system you are using. This answer is correct in the base-10, or decimal, number system, which is the number system humans use every day. But that answer is not correct in other number systems.

The **base** of a number system specifies the number of digits used in the system. The digits always begin with 0 and continue through one less than the base. For example, there are 2 digits in base 2: 0 and 1. There are 8 digits in base 8: 0 through 7. There are 10 digits in base 10: 0 through 9. The base also determines what the positions of digits mean. When you add 1 to the last digit in the number system, you have a carry to the digit position to the left.

Numbers are written using **positional notation**. The rightmost digit represents its value multiplied by the base to the zeroth power. The digit to the left of that one represents its value multiplied by the base to the first power. The next digit represents its value multiplied by the base to the second power. The next digit represents its value multiplied by the base to the third power, and so on. You are so familiar with positional notation that you probably don't think about it. We used it instinctively to calculate the number of ones in 943.

$$\begin{array}{r} 9 * 10^2 = 9 * 100 = 900 \\ + 4 * 10^1 = 4 * 10 = 40 \\ + 3 * 10^0 = 3 * 1 = \underline{3} \\ \hline 943 \end{array}$$

A more formal way of defining positional notation is to say that the value is represented as a polynomial in the base of the number system. But what is a polynomial? A polynomial is a sum of two or more algebraic terms, each of which consists of a constant multiplied by one or more variables raised to a nonnegative integral power. When defining positional notation, the variable is the base of the number system. Thus 943 is represented as a polynomial as follows, with x acting as the base:

$$9 * x^2 + 4 * x^1 + 3 * x^0$$

Let's express this idea formally. If a number in the base- R number system has n digits, it is represented as follows, where d_i represents the digit in the i th position in the number:

$$d_n * R^{n-1} + d_{n-1} * R^{n-2} + \dots + d_2 * R + d_1$$

Look complicated? Let's look at a concrete example: 63578 in base 10. Here n is 5 (the number has five digits), and R is 10 (the base). The formula

Base The foundational value of a number system, which dictates the number of digits and the value of digit positions

Positional notation A system of expressing numbers in which the digits are arranged in succession, the position of each digit has a place value, and the number is equal to the sum of the products of each digit by its place value¹

The importance of zero

?

Positional notation is possible only because of the concept of zero. Zero was the fundamental concept at the intersection of all branches of modern mathematics. As Georges Ifrah noted in his book *The Universal History of Computing*: "To sum up, the vital discovery of zero gave the human mind an extraordinarily powerful potential. No other human creation has exercised such an influence on the development of mankind's intelligence."²

says that the fifth digit (last digit on the left) is multiplied by the base to the fourth power; the fourth digit is multiplied by the base to the third power; the third digit is multiplied by the base to the second power; the second digit is multiplied by the base to the first power; and the first digit is not multiplied by anything.

$$6 * 10^4 + 3 * 10^3 + 5 * 10^2 + 7 * 10^1 + 8$$

In the previous calculation, we assumed that the number base is 10. This is a logical assumption because our number system *is* base 10. However, there is no reason why the number 943 couldn't represent a value in base 13. If so, to determine the number of ones, we would have to convert it to base 10.

$$\begin{array}{r} 9 * 13^2 = 9 * 169 = 1521 \\ + 4 * 13^1 = 4 * 13 = 52 \\ + 3 * 13^0 = 3 * 1 = \underline{3} \\ \hline 1576 \end{array}$$

Therefore, 943 in base 13 is equal to 1576 in base 10. Keep in mind that these two numbers have an equivalent value. That is, both represent the same number of things. If one bag contains 943 (base 13) beans and a second bag contains 1576 (base 10) beans, then both bags contain the exact same number of beans. Number systems just allow us to represent values in various ways.

Note that in base 10, the rightmost digit is the “ones” position. In base 13, the rightmost digit is also the “ones” position. In fact, this is true for any base, because anything raised to the power 0 is 1.

Why would anyone want to represent values in base 13? It isn't done very often, granted, but it is another example that demonstrates how all number systems work. For example, a computing technique called *hashing* takes numbers and scrambles them, and one way to scramble numbers is to interpret them in a different base.

Other bases, such as base 2 (binary), are particularly important in computer processing. Let's explore these bases in more detail.

Binary, Octal, and Hexadecimal

The base-2 (binary) number system is particularly important in computing. It is also helpful to be familiar with number systems that are powers of 2, such as base 8 (octal) and base 16 (hexadecimal). Recall that the base value specifies the number of digits in the number system. Base 10 has ten digits (0–9), base 2 has two digits (0–1), and base 8 has eight digits (0–7).

Therefore, the number 943 could not represent a value in any base less than base 10, because the digit 9 doesn't exist in those bases. It is, however, a valid number in base 10 or any base higher than that. Likewise, the number 2074 is a valid number in base 8 or higher, but it simply does not exist (because it uses the digit 7) in any base lower than that.

What are the digits in bases higher than 10? We need symbols to represent the digits that correspond to the decimal values 10 and beyond. In bases higher than 10, we use letters as digits. We use the letter A to represent the number 10, B to represent 11, C to represent 12, and so forth. Therefore, the 16 digits in base 16 are:

0, 1, 2, 3, 4, 5, 6, 7, 8, 9, A, B, C, D, E, F

Let's look at values in octal, hexadecimal, and binary to see what they represent in base 10. For example, let's calculate the decimal equivalent of 754 in octal (base 8). As before, we just expand the number in its polynomial form and add up the numbers.

$$\begin{array}{r} 7 * 8^2 = 7 * 64 = 448 \\ + 5 * 8^1 = 5 * 8 = 40 \\ + 4 * 8^0 = 4 * 1 = \underline{4} \\ \hline 492 \end{array}$$

Let's convert the hexadecimal number ABC to decimal:

$$\begin{array}{r} A * 16^2 = 10 * 256 = 2560 \\ + B * 16^1 = 11 * 16 = 176 \\ + C * 16^0 = 12 * 1 = \underline{12} \\ \hline 2748 \end{array}$$

Note that we perform the exact same calculation to convert the number to base 10. We just use a base value of 16 this time, and we have to remember what the letter digits represent. After a little practice you won't find the use of letters as digits that strange.

Finally, let's convert a binary (base-2) number 1010110 to decimal. Once again, we perform the same steps—only the base value changes:

$$\begin{array}{r} 1 * 2^6 = 1 * 64 = 64 \\ + 0 * 2^5 = 0 * 32 = 0 \\ + 1 * 2^4 = 1 * 16 = 16 \\ + 0 * 2^3 = 0 * 8 = 0 \\ + 1 * 2^2 = 1 * 4 = 4 \\ + 1 * 2^1 = 1 * 2 = 2 \\ + 0 * 2^0 = 0 * 1 = \underline{0} \\ \hline 86 \end{array}$$

Largest Prime Number ?

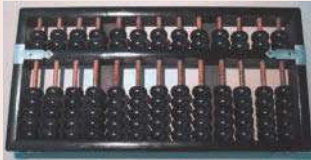
The largest prime number ever discovered (as of June 2018) is one less than the number 2 raised to the 77,232,917th power. It has 23,249,425 digits.⁷

This latest prime number was discovered by the Great Internet Mersenne Prime Search (GIMPS) project, which is a collaborative effort of volunteers who use free software to conduct the search.

Euclid proved that there is no largest prime number, so the search continues.

The Abacus

In our brief history of computing in Chapter 1, we mentioned the abacus as an early computing device. More specifically, the abacus is a device that uses positional notation to represent a decimal number. The beads in any one column represent the digit in that column. All columns combined represent a complete number.



Courtesy of Theresa DiDonato

The beads above the middle bar represent units of 5 and the beads below the bar each represent 1. Beads pushed away from the middle bar do not contribute to the number. The following diagram shows the number 27,091 represented on an abacus:



Courtesy of Theresa DiDonato

The user performs calculations by moving the beads in specific ways to reflect the basic arithmetic operations of addition, subtraction, multiplication, and division.

Though ancient, the abacus is still used today in some Asian cultures. In stores, a checkout clerk might use an abacus instead of an electronic cash register. Although lacking some of the advantages of electronic devices, the abacus is more than sufficient for the kinds of calculations needed for basic business transactions. Skilled users of an abacus can rival anyone with a calculator in terms of both speed and accuracy.

Children in these cultures learn rote operations on the abacus, much as you were drilled in your multiplication tables. To perform an operation on a number, the user executes a series of movements using only the thumb, pointing finger, and middle finger of one hand. These movements correspond to individual digits and depend on the operation being performed. For example, to add the digit 7 to the digit 5 already showing on the abacus, the user clears the five marker (pushes it to the top), pushes 2 onto the bar from below, and increments 1 in the next column. Though this move corresponds to the basic addition operation we do on paper, the abacus user is not thinking about the mathematics. The user is conditioned to execute a specific movement when specific digits are encountered for a specific operation. When the calculation is complete, the user reads the result as shown on the abacus.

Recall that the digits in any number system go up to one less than the base value. To represent the base value in any base, you need two digits. A 0 in the rightmost position and a 1 in the second position represent the value of the base itself. Thus 10 is ten in base 10, 10 is eight in base 8,

Bi-quinary Number Representation

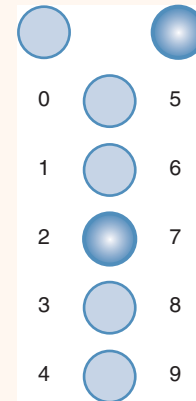
The console of the IBM 650, a popular commercial computer in the late 1950s, allowed the operator to read the contents of memory using the bi-quinary system. This number representation system uses seven lights to represent the 10 decimal digits.



Courtesy of IBM Corporate Archives, © International Business Machines Corporation

Each digit is represented by two lights, one of the top two and one of the bottom five. If the upper-left light is on, the five other lights represent 0, 1, 2, 3, and 4, respectively, from top to bottom. If the upper-right light is on, the five

other lights represent 5, 6, 7, 8, and 9. The following configuration represents the number 7:



The IBM 650 was called “the Ford Tri-Motor of computers”: Like the Ford Tri-Motor, old IBM 650s were shipped to Latin America, where they enjoyed an extended life.

and 10 is sixteen in base 16. Think about it. The consistency of number systems is actually quite elegant.

Addition and subtraction of numbers in other bases are performed exactly like they are on decimal numbers.

Arithmetic in Other Bases

Recall the basic idea of arithmetic in decimal: $0 + 1$ is 1, $1 + 1$ is 2, $2 + 1$ is 3, and so on. Things get interesting when you try to add two numbers whose sum is equal to or larger than the base value—for example, $1 + 9$. Because there isn’t a symbol for 10, we reuse the same digits and rely on position. The rightmost digit reverts to 0, and there is a carry into the next position to the left. Thus $1 + 9$ equals 10 in base 10.

The rules of binary arithmetic are analogous, but we run out of digits much sooner. That is, $0 + 1$ is 1, and $1 + 1$ is 0 with a carry. Then the same

Chapter 2: Binary Values and Number Systems

rule is applied to every column in a larger number, and the process continues until we have no more digits to add. The example below adds the binary values 101110 and 11011. The carry value is marked above each column in color.

$$\begin{array}{r}
 11111 \quad \leftarrow \text{carry} \\
 101110 \\
 + \quad \underline{11011} \\
 \hline
 1001001
 \end{array}$$

We can convince ourselves that this answer is correct by converting both operands to base 10, adding them, and comparing the result: 101110 is 46, 11011 is 27, and the sum is 73. Of course, 1001001 is 73 in base 10.

The subtraction facts that you learned in grade school were that $9 - 1$ is 8, $8 - 1$ is 7, and so on, until you try to subtract a larger digit from a smaller one, such as $0 - 1$. To accomplish this feat, you have to “borrow one” from the next left digit of the number from which you are subtracting. More precisely, you borrow one power of the base. So, in base 10, when you borrow, you borrow 10. The same logic applies to binary subtraction. Every time you borrow in a binary subtraction, you borrow 2. Here are two examples with the borrowed values marked above.

$$\begin{array}{r}
 1 \\
 0\cancel{1}2 \quad \leftarrow \text{borrow} \\
 111001 \\
 - \quad \underline{110} \\
 \hline
 110011
 \end{array}
 \qquad
 \begin{array}{r}
 02 \\
 \cancel{0}2 \quad \leftarrow \text{borrow} \\
 111101 \\
 - \quad \underline{110} \\
 \hline
 110111
 \end{array}$$

Once again, you can check the calculation by converting all values to base 10 and subtracting to see if the answers correspond.

Power-of-2 Number Systems

Binary and octal numbers share a very special relationship: Given a number in binary, you can read it off in octal; given a number in octal, you can read it off in binary. For example, take the octal number 754. If you replace each digit with the binary representation of that digit, you have 754 in binary. That is, 7 in octal is 111 in binary, 5 in octal is 101 in binary, and 4 in octal is 100 in binary, so 754 in octal is 111101100 in binary.

To facilitate this type of conversion, the table below shows counting in binary from 0 through 10 with their octal and decimal equivalents.

BINARY	OCTAL	DECIMAL
0	0	0
1	1	1
10	2	2
11	3	3
100	4	4
101	5	5
110	6	6
111	7	7
1000	10	8
1001	11	9
1010	12	10

To convert from binary to octal, you start at the rightmost binary digit and mark the digits in groups of threes. Then you convert each group of three to its octal value.

$$\begin{array}{ccc} \underline{111} & \underline{101} & \underline{100} \\ 7 & 5 & 4 \end{array}$$

Let's convert the binary number 1010110 to octal, and then convert that octal value to decimal. The answer should be the equivalent of 1010110 in decimal, or 86.

$$\begin{array}{ccc} \underline{1} & \underline{010} & \underline{110} \\ 1 & 2 & 6 \end{array}$$

$$\begin{array}{r} 1 * 8^2 = 1 * 64 = 64 \\ + 2 * 8^1 = 2 * 8 = 16 \\ + 6 * 8^0 = 6 * 1 = \underline{6} \\ \hline 86 \end{array}$$

The reason that binary can be immediately converted to octal and octal to binary is that 8 is a power of 2. There is a similar relationship between binary and hexadecimal. Every hexadecimal digit can be represented in four binary digits. Let's take the binary number 1010110

Can you count to three?

Not instinctively! Cognitive psychologists have demonstrated that preschool children do not identify more than three sets: a set of one object, two objects, and three or more objects (also called *many*). Until some two centuries ago, numerous languages had only two or three number words: words for *single*, *pair*, and *many*. We still have such words in English: *gang*, *pile*, *bunch*, *flock*, *herd*, *school*, *fleet*, *pride*, *pack*, and *gaggle*.³

Chapter 2: Binary Values and Number Systems

and convert it to hexadecimal by marking the digits from right to left in groups of four.

$$\begin{array}{r} \underline{101} \quad \underline{0110} \\ 5 \quad \quad 6 \end{array}$$

$$\begin{array}{r} 5 * 16^1 = 5 * 16 = 80 \\ + 6 * 16^0 = 6 * 1 = \underline{6} \\ 86 \end{array}$$

Now let's convert ABC in hexadecimal to binary. It takes four binary digits to represent each hex digit. A in hexadecimal is 10 in decimal and therefore is 1010 in binary. Likewise, B in hexadecimal is 1011 in binary, and C in hexadecimal is 1100 in binary. Therefore, ABC in hexadecimal is 101010111100 in binary.

Rather than confirming that 101010111100 is 2748 in decimal directly, let's mark it off in octal and convert the octal.

$$\begin{array}{r} \underline{101} \quad \underline{010} \quad \underline{111} \quad \underline{100} \\ 5 \quad \quad 2 \quad \quad 7 \quad \quad 4 \end{array}$$

Thus 5274 in octal is 2748 in decimal.

In the next section, we show how to convert base-10 numbers to the equivalent number in another base.

Converting from Base 10 to Other Bases

The rules for converting base-10 numbers involve dividing by the base into which you are converting the number. From this division, you get a quotient and a remainder. The remainder becomes the next digit in the new number (going from right to left), and the quotient replaces the number to be converted. The process continues until the quotient is zero. Let's write the rules in a different form.

© Artur Debat/Getty Images, © Alan Dyer/Stocktrek Images/Getty Images

WHILE (the quotient is not zero)

 Divide the decimal number by the new base

 Make the remainder the next digit to the left in the answer

 Replace the decimal number with the quotient

These rules form an *algorithm* for converting from base 10 to another base. An algorithm is a logical sequence of steps that solves a problem.

We have much more to say about algorithms in later chapters. Here we show one way of describing an algorithm and then apply it to perform the conversions.

The first line of the algorithm tells us to repeat the next three lines until the quotient from our division becomes zero. Let's convert the decimal number 2748 to hexadecimal. As we've seen in previous examples, the answer should be ABC.

$$\begin{array}{r}
 171 \quad \leftarrow \text{quotient} \\
 16 \overline{)2748} \\
 \underline{16} \\
 114 \\
 \underline{112} \\
 28 \\
 \underline{16} \\
 12 \quad \leftarrow \text{remainder}
 \end{array}$$

The remainder (12) is the first digit in the hexadecimal answer, represented by the digit C. So the answer so far is C. Since the quotient is not zero, we divide it (171) by the new base.

$$\begin{array}{r}
 10 \quad \leftarrow \text{quotient} \\
 16 \overline{)171} \\
 \underline{16} \\
 11 \quad \leftarrow \text{remainder}
 \end{array}$$

The remainder (11) is the next digit to the left in the answer, which is represented by the digit B. Now the answer so far is BC. Since the quotient is not zero, we divide it (10) by the new base.

$$\begin{array}{r}
 0 \quad \leftarrow \text{quotient} \\
 16 \overline{)10} \\
 \underline{0} \\
 10 \quad \leftarrow \text{remainder}
 \end{array}$$

The remainder (10) is the next digit to the left in the answer, which is represented by the digit A. Now the answer is ABC. The quotient is zero, so we are finished, and the final answer is ABC.

Binary Values and Computers

Although some of the early computers were decimal machines, modern computers are binary machines. That is, numbers within the computer are represented in binary form. In fact, all information is somehow

© Artur Debat/Getty Images; © Alan Dyer/Stocktrek Images/Getty Images

Grace Murray Hopper

From 1943 until her death on New Year's Day in 1992, Admiral Grace Murray Hopper was intimately involved with computing. In 1991, she was awarded the National Medal of Technology “for her pioneering accomplishments in the development of computer programming languages that simplified computer technology and opened the door to a significantly larger universe of users.”

Admiral Hopper was born Grace Brewster Murray in New York City on December 9, 1906. She attended Vassar and received a PhD in mathematics from Yale. For the next 10 years, she taught mathematics at Vassar.

In 1943, Admiral Hopper joined the U.S. Navy and was assigned to the Bureau of Ordnance Computation Project at Harvard University as a programmer on the Mark I. After the war, she remained at Harvard as a faculty member and continued work on the Navy's Mark II and Mark III computers. She loved to tell the story of how, while she was working on the Mark II, one of the operators discovered the first computer “bug”—a moth caught in one of the relays. In 1949, she joined Eckert-Mauchly Computer Corporation and worked on the UNIVAC I.

Admiral Hopper had a working compiler in 1952, a time when the conventional wisdom was that computers could do only arithmetic. Although not on the committee that designed the computer language COBOL, she was active in its design, implementation, and use. COBOL (which stands for *Common Business-Oriented Language*) was developed in the early 1960s.

Admiral Hopper retired from the Navy in 1966, only to be recalled within a year to

full-time active duty. Her mission was to oversee the Navy's efforts to maintain uniformity in programming languages. Rear Admiral Hopper was considered the mother of computerized data automation in the Navy. She served with the Naval Data Automation Command until she retired again in 1986 with the rank of Rear Admiral.

Admiral Hopper loved young people and enjoyed giving talks on college and university campuses. She often handed out colored wires, which she called *nanoseconds* because they were cut to a length of about one foot—the distance that light travels in a nanosecond (billionth of a second). Her advice to the young was, “You manage things, you lead people. We went overboard on management and forgot about the leadership.”

During her lifetime, Admiral Hopper received honorary degrees from more than 40 colleges and universities. She was honored by her peers on several occasions, including the Contributors to Computer Science Education Award given by the Special Interest Group for Computer Science Education (SIGCSE), which is part of the ACM (Association for Computing Machinery). Nell Dale, when notifying Admiral Hopper of the SIGCSE award, asked of which of her many accomplishments she was most proud. She answered, “All the young people I have trained over the years.”

Today, the Grace Hopper Celebration is an annual gathering of women technologists.



© Cynthia Johnson/Getty Images

represented using binary values. The reason is that each storage location within a computer contains either a low-voltage signal or a high-voltage signal. Because each location can have only one of two states, it is logical to equate those states to 0 and 1. A low-voltage signal is equated with a 0, and a high-voltage signal is equated with a 1. In fact, you can forget about voltages and think of each storage location as containing either a 0 or a 1. Note that a storage location cannot be empty: It must contain either a 0 or a 1.

Each storage unit is called a **binary digit**, or **bit** for short. Bits are grouped together into **bytes** (8 bits), and bytes are grouped together into units called **words**. The number of bits in a word is known as the *word length* of the computer. For example, IBM 370 architecture in the late 1970s had half words (2 bytes or 16 bits), full words (4 bytes), and double words (8 bytes). Modern computers are often 32-bit machines or 64-bit machines.

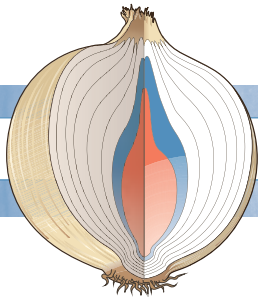
We have much more to explore about the relationship between computers and binary numbers. In the next chapter, we examine many kinds of data and see how they are represented in a computer. In Chapter 4, we see how to control electrical signals that represent binary values. In Chapter 6, we see how binary numbers are used to represent program commands that the computer executes.

Binary digit A digit in the binary number system; a 0 or a 1

Bit Binary digit

Byte Eight binary digits

Word A group of one or more bytes; the number of bits in a word is the word length of the computer



© Artur Debat/Getty Images; © Alan Dyer/Stocktrek Images/Getty Images

SUMMARY

Numbers are written using positional notation, in which the digits are arranged in succession, the position of each digit has a place value, and the number is equal to the sum of the products of each digit by its place value. The place values are powers of the base of the number system. Thus, in the decimal number system, the place values are powers of 10; in the binary number system, the place values are powers of 2.

Arithmetic can be performed on numbers in any base represented in positional notation. The same operational rules apply to other bases as they do to base 10. Adding 1 to the largest digit in the base causes a carry into the next position.

Base 2, base 8, and base 16 are all related because these bases are powers of 2. This relationship provides a quick way to convert between numbers in these bases. Computer hardware is designed using numbers in base 2. A low-voltage signal is equated with 0, and a high-voltage signal is equated with 1.



ETHICAL ISSUES

The FISA Court

The United States Foreign Intelligence Surveillance Court is a U.S. federal court that was established under the Foreign Intelligence Surveillance Act of 1978 (FISA). The Court handles requests by federal law enforcement agencies for surveillance warrants against suspected foreign intelligence agents operating inside the United States.⁴

Before 2013, when Edward Snowden leaked that the Court had ordered a subsidiary of Verizon to provide detailed call records to the National Security Agency (NSA), most people had never heard of the FISA Court.

The FISA Court comprises 11 judges who sit for 7-year terms. The Chief Justice of the Supreme Court appoints the judges, without confirmation. An application for an electronic surveillance warrant is made before one of the judges. The court may amend this application before granting the warrant. If the application is denied, the government may not take the same request to another judge. If

the U.S. Attorney General determines that an emergency exists, he or she may authorize the electronic surveillance but must notify a Court judge not more than 72 hours after the authorization. The USA PATRIOT Act of 2001 expanded the time periods during which surveillance may be authorized.⁵

In December 2012, President Obama signed the FISA Amendments Act Reauthorization Act of 2012, which extended Title VII of FISA until December 31, 2017. In January, 2018, President Trump reauthorized it again through 2023.

Title VII of FISA, added by the FISA Amendments Act of 2008, created separate procedures for targeting suspected foreign intelligence agents, including non-U.S. persons and U.S. persons reasonably believed to be outside the United States.⁶

Note that the stated intent of the FISA Court is to protect the United States as well as the rights of U.S. citizens.

© Artur Debat/Getty Images; © Alan Dyer/Stocktrek Images/Getty Images

KEY TERMS

Base
Binary digit
Bit
Byte
Integer
Natural number

Negative number
Number
Positional notation
Rational number
Word

EXERCISES

For Exercises 1–5, match the following numbers with their definition.

- A. Number
 - B. Natural number
 - C. Integer number
 - D. Negative number
 - E. Rational number
1. A unit of an abstract mathematical system subject to the laws of arithmetic
 2. A natural number, a negative of a natural number, or zero
 3. The number zero and any number obtained by repeatedly adding one to it
 4. An integer or the quotient of two integers (division by zero excluded)
 5. A value less than zero, with a sign opposite to its positive counterpart

For Exercises 6–11, match the solution with the problem.

- A. 10001100
 - B. 10011110
 - C. 1101010
 - D. 1100000
 - E. 1010001
 - F. 1111000
6. $1110011 + 11001$ (binary addition)
 7. $1010101 + 10101$ (binary addition)
 8. $1111111 + 11111$ (binary addition)
 9. $1111111 - 111$ (binary subtraction)
 10. $1100111 - 111$ (binary subtraction)
 11. $1010110 - 101$ (binary subtraction)

For Exercises 12–17, mark the answers true or false as follows:

- A. True
 - B. False
12. Binary numbers are important in computing because a binary number can be converted into every other base.
 13. Binary numbers can be read off in hexadecimal but not in octal.
 14. Starting from left to right, every grouping of four binary digits can be read as one hexadecimal digit.
 15. A byte is made up of six binary digits.
 16. Two hexadecimal digits cannot be stored in one byte.
 17. Reading octal digits off as binary produces the same result whether read from right to left or from left to right.

Exercises 18–47 are problems or short-answer questions.

18. Distinguish between a natural number and a negative number.
19. Distinguish between a natural number and a rational number.
20. Label the following numbers as natural, negative, or rational.
 - a. 1.333333
 - b. $-1/3$
 - c. 1066
 - d. $2/5$
 - e. 6.2
 - f. π (pi)

EXERCISES (CONTINUED)

21. How many ones are there in 891 if it is a number in each of the following bases?
 - a. Base 10
 - b. Base 8
 - c. Base 12
 - d. Base 13
 - e. Base 16
22. Express 891 as a polynomial in each of the bases in Exercise 21.
23. Convert the following numbers from the base shown to base 10.
 - a. 111 (base 2)
 - b. 777 (base 8)
 - c. FEC (base 16)
 - d. 777 (base 16)
 - e. 111 (base 8)
24. Explain how base 2 and base 8 are related.
25. Explain how base 8 and base 16 are related.
26. Expand the table on page 43 to include the decimals from 11 through 16.
27. Expand the table in Exercise 26 to include hexadecimal numbers.
28. Convert the following binary numbers to octal.
 - a. 111110110
 - b. 1000001
 - c. 10000010
 - d. 1100010
29. Convert the following binary numbers to hexadecimal.
 - a. 10101001
 - b. 11100111
 - c. 01101110
 - d. 01111111
30. Convert the following hexadecimal numbers to octal.
 - a. A9
 - b. E7
 - c. 6E
31. Convert the following octal numbers to hexadecimal.
 - a. 777
 - b. 605
 - c. 443
 - d. 521
 - e. 1
32. Convert the following decimal numbers to octal.
 - a. 901
 - b. 321
 - c. 1492
 - d. 1066
 - e. 2001
33. Convert the following decimal numbers to binary.
 - a. 45
 - b. 69
 - c. 1066
 - d. 99
 - e. 1

EXERCISES (CONTINUED)

34. Convert the following decimal numbers to hexadecimal.
 - a. 1066
 - b. 1939
 - c. 1
 - d. 998
 - e. 43
35. If you were going to represent numbers in base 18, which symbols might you use to represent the decimal numbers 10 through 17 other than letters?
36. Convert the following decimal numbers to base 18 using the symbols you suggested in Exercise 35.
 - a. 1066
 - b. 99099
 - c. 1
37. Perform the following octal additions.
 - a. $770 + 665$
 - b. $101 + 707$
 - c. $202 + 667$
38. Perform the following hexadecimal additions.
 - a. $19AB6 + 43$
 - b. $AE9 + F$
 - c. $1066 + ABCD$
39. Perform the following octal subtractions.
 - a. $1066 - 776$
 - b. $1234 - 765$
 - c. $7766 - 5544$
40. Perform the following hexadecimal subtractions.
 - a. $ABC - 111$
 - b. $9988 - AB$
 - c. $A9F8 - 1492$
41. Why are binary numbers important in computing?
42. How many bits does a byte contain?
43. How many bytes are there in a 64-bit machine?
44. Why do microprocessors such as pagers have only 8-bit words?
45. Why is it important to study how to manipulate fixed-size numbers?
46. How many ones are there in the number AB98 in base 13?
47. Describe how a bi-quinary number representation works.

THOUGHT QUESTIONS

1. Exercise 20 asked you to classify π as one of the options. π does not belong in any of the categories named; π (and e) are transcendental numbers. Look up *transcendental numbers* in the dictionary or in an old math book and give the definition in your own words.
2. Complex numbers are another category of numbers that are not discussed in this chapter. Look up *complex numbers* in a dictionary or an old math book and give the definition in your own words.
3. Many everyday occurrences can be represented as a binary bit. For example, a door is open or closed, the stove is on or off, and the dog is asleep or awake. Could relationships be represented as a binary value? Discuss the question, giving examples.
4. Had you heard of the FISA Court before reading this chapter? Do you now have a better understanding of what it is?

Laying the Groundwork

- 1 The Big Picture

The Information Layer

- 2 Binary Values and Number Systems
- 3 Data Representation

The Hardware Layer

- 4 Gates and Circuits
- 5 Computing Components

The Programming Layer

- 6 Low-Level Programming Languages and Pseudocode
- 7 Problem Solving and Algorithms
- 8 Abstract Data Types and Subprograms
- 9 Object-Oriented Design and High-Level Programming Languages

The Operating Systems Layer

- 10 Operating Systems
- 11 File Systems and Directories

The Applications Layer

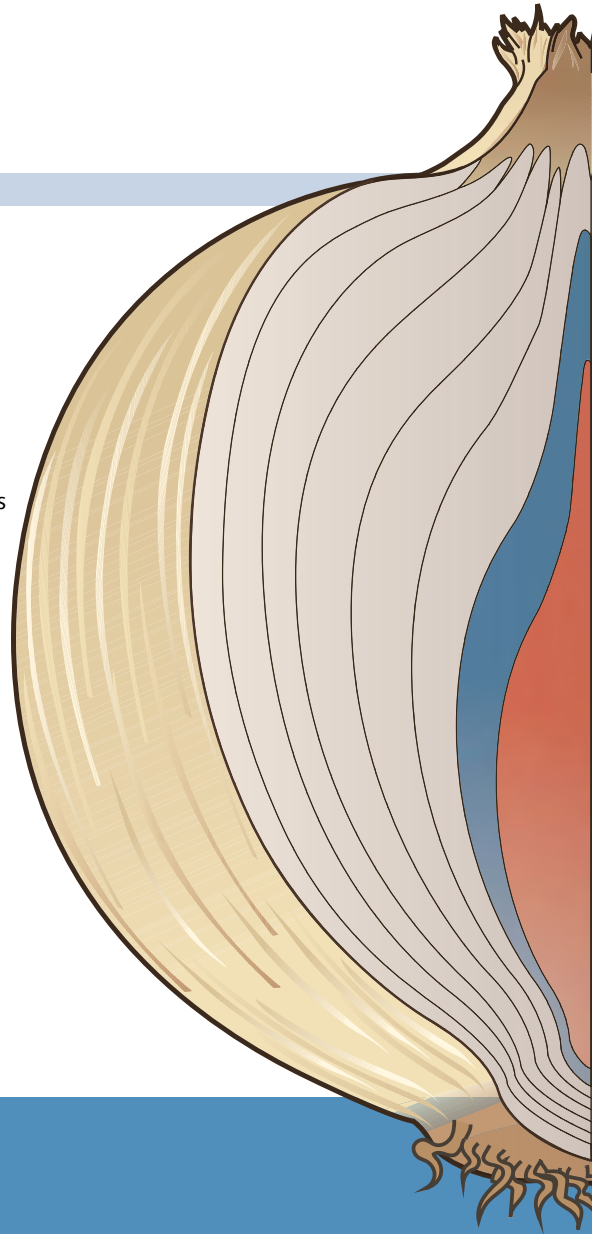
- 12 Information Systems
- 13 Artificial Intelligence
- 14 Simulation, Graphics, Gaming, and Other Applications

The Communications Layer

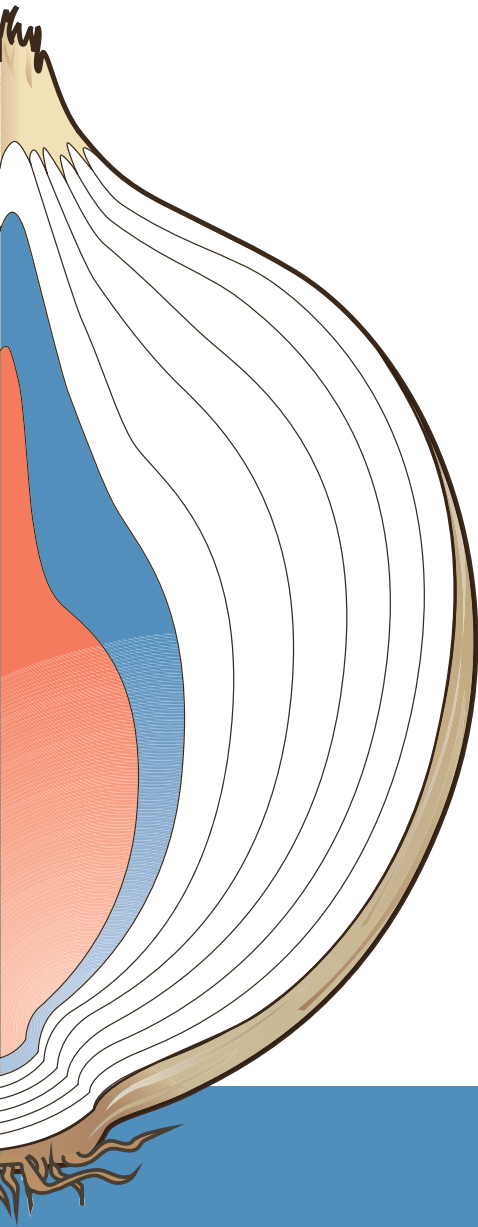
- 15 Networks
- 16 The World Wide Web
- 17 Computer Security

In Conclusion

- 18 Limitations of Computing



THE INFORMATION LAYER



3

DATA REPRESENTATION

When you go on a trip, you might make use of a road map—either the old-fashioned, fold-out kind or an electronic version presented by a navigation system. Whatever form it takes, the map is not the land over which you travel, but rather a *representation* of that land. The map has captured some of the information needed to accomplish the goal of getting from one place to another.

Likewise, the data we need to store and manage on a computer must be represented in a way that captures the essence of the information we care about, and it must do so in a form convenient for computer processing. Building on the fundamental concepts of the binary number system established in Chapter 2, this chapter explores how we represent and store the various kinds of data a computer manages.

GOALS

After studying this chapter, you should be able to:

- distinguish between analog and digital data.
- explain data compression and calculate compression ratios.
- explain the binary formats for negative and floating-point values.
- describe the characteristics of the ASCII and Unicode character sets.
- perform various types of text compression.
- explain the nature of sound and its representation.
- explain how RGB values define a color.
- distinguish between raster and vector graphics.
- explain temporal and spatial video compression.

3.1 Data and Computers

Without data, computers would be useless. Every task a computer undertakes deals with managing data in some way. Therefore, our need to represent and organize data in appropriate ways is paramount.

Let's start by distinguishing the terms *data* and *information*. Although these terms are often used interchangeably, making the distinction is sometimes useful, especially in computing. **Data** is basic values or facts, whereas **information** is data that has been organized and/or processed in a way that is useful in solving some kind of problem. Data can be unstructured and lack context. Information helps us answer questions (it "informs"). This distinction, of course, is relative to the needs of the user, but it captures the essence of the role that computers play in helping us solve problems.

In this chapter, we focus on representing different types of data. In later chapters, we discuss the various ways to organize data so as to solve particular types of problems.

In the not-so-distant past, computers dealt almost exclusively with numeric and textual data. Today, however, computers are truly **multimedia** devices, dealing with a vast array of information categories. Computers store, present, and help us modify many different types of data:

- Numbers
- Text
- Audio
- Images and graphics
- Video

Ultimately, all of this data is stored as binary digits. Each document, picture, and sound bite is somehow represented as strings of 1s and 0s. This chapter explores each of these types of data in turn and discusses the basic ideas behind the ways in which we represent these types of data on a computer.

We can't discuss data representation without also talking about **data compression**—reducing the amount of space needed to store a piece of data. In the past, we needed to keep data small because of storage limitations. Today, computer storage is relatively cheap—but now we have an even more pressing reason to shrink our data: the need to share it with others. The Web and its underlying networks have inherent **bandwidth** restrictions that define the maximum number of bits or bytes that can be transmitted from one place to another in a fixed amount of time. In particular, today's emphasis on streaming video (video played as it is downloaded from the Web) motivates the need for efficient representation of data.

Data Basic values or facts

Information Data that has been organized or processed in a useful manner

Multimedia Several different media types

Data compression Reducing the amount of space needed to store a piece of data

Bandwidth The number of bits or bytes that can be transmitted from one place to another in a fixed amount of time

The **compression ratio** gives an indication of how much compression occurs. The compression ratio is the size of the compressed data divided by the size of the original data. The values could be in bits or characters (or whatever is appropriate), as long as both values measure the same thing. The ratio should result in a number between 0 and 1. The closer the ratio is to zero, the tighter the compression.

A data compression technique can be **lossless**, which means the data can be retrieved without losing any of the original information, or it can be **lossy**, in which case some information is lost in the process of compaction. Although we never want to lose information, in some cases this loss is acceptable. When dealing with data representation and compression, we always face a tradeoff between accuracy and size.

Analog and Digital Data

The natural world, for the most part, is continuous and infinite. A number line is continuous, with values growing infinitely large and small. That is, you can always come up with a number that is larger or smaller than any given number. Likewise, the numeric space between two integers is infinite. For instance, any number can be divided in half. But the world is not just infinite in a mathematical sense. The spectrum of colors is a continuous rainbow of infinite shades. Objects in the real world move through continuous and infinite space. Theoretically, you could always close the distance between you and a wall by half, and you would never actually reach the wall.

Computers, by contrast, are finite. Computer memory and other hardware devices have only so much room to store and manipulate a certain amount of data. We always fail in our attempt to represent an infinite world on a finite machine. The goal, then, is to represent enough of the world to satisfy our computational needs and our senses of sight and sound. We want to make our representations good enough to get the job done, whatever that job might be.

Data can be represented in one of two ways: analog or digital. **Analog data** is a continuous representation, analogous to the actual information it represents. **Digital data** is a discrete representation, breaking the information up into separate elements.

A mercury thermometer is an analog device. The mercury rises in a continuous flow in the tube in direct proportion to the temperature. We calibrate and mark the tube so that we can read the current temperature, usually as an integer such as 75 degrees Fahrenheit. However, the

Compression ratio

The size of the compressed data divided by the size of the uncompressed data

Lossless compression

A data compression technique in which there is no loss of information

Lossy compression

A data compression technique in which there is loss of information

Analog data

A continuous representation of data

Digital data

A discrete representation of data

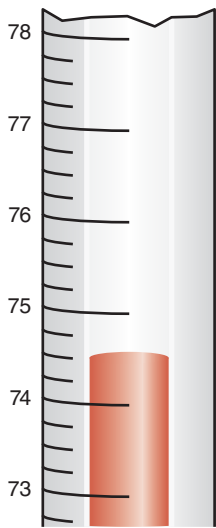


FIGURE 3.1 A mercury thermometer continually rises in direct proportion to the temperature

mercury in such a thermometer is actually rising in a continuous manner between degrees. At some point in time, the temperature is actually 74.568 degrees Fahrenheit, and the mercury is accurately indicating that, even if our markings are not detailed enough to note such small changes. See **FIGURE 3.1**.

Analog data is directly proportional to the continuous, infinite world around us. Computers, therefore, cannot work well with analog data. Instead, we **digitize** data by breaking it into pieces and representing those pieces separately. Each of the representations discussed in this chapter takes a continuous entity and separates it into discrete elements. Those discrete elements are then individually represented using binary digits.

But why do we use the binary system? We know from Chapter 2 that binary is just one of many equivalent number systems. Couldn't we use, say, the decimal number system, with which we are already more familiar? We could. In fact, it's been done. Computers have been built that are based on other number systems. However, modern computers are designed to use and manage binary values because the devices that store and manage the data are far less expensive and far more reliable if they have to represent only one of two possible values.

Also, electronic signals are far easier to maintain if they transfer only binary data. An analog signal continually fluctuates up and down in voltage, but a digital signal has only a high or low state, corresponding to the two binary digits. See **FIGURE 3.2**.

All electronic signals (both analog and digital) degrade as they move down a line. That is, the voltage of the signal fluctuates due to environmental effects. The trouble is that as soon as an analog signal degrades, information is lost. Because any voltage level within the range is valid, it's impossible to know what the original signal state was or even that it changed at all.

Digital signals, by contrast, jump sharply between two extremes—a behavior referred to as **pulse-code modulation** (PCM). A digital signal can become degraded by quite a bit before any information is lost, because any voltage value above a certain threshold is considered a high value, and any value below that threshold is considered a low value. Periodically, a digital signal is **relocked** to regain its original shape. As long as it

Digitize The act of breaking information down into discrete pieces

Pulse-code modulation Variation in a signal that jumps sharply between two extremes

Relock The act of reasserting an original digital signal before too much degradation occurs



FIGURE 3.2 An analog signal and a digital signal

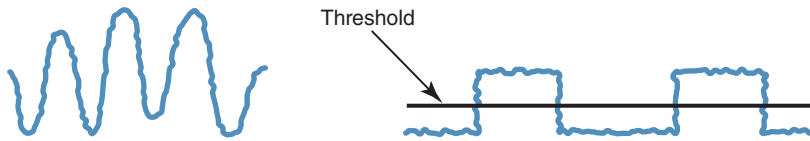


FIGURE 3.3 Degradation of analog and digital signals

is relocked before too much degradation occurs, no information is lost.

FIGURE 3.3 shows the degradation effects of analog and digital signals.

Binary Representations

As we investigate the details of representing particular types of data, it's important to remember the inherent nature of using binary. One bit can be either 0 or 1. There are no other possibilities. Therefore, one bit can represent only two things. For example, if we wanted to classify a food as being either sweet or sour, we would need only one bit to do it. We could say that if the bit is 0, the food is sweet, and if the bit is 1, the food is sour. But if we want to have additional classifications (such as spicy), one bit is not sufficient.

To represent more than two things, we need multiple bits. Two bits can represent four things because four combinations of 0 and 1 can be made from two bits: 00, 01, 10, and 11. For instance, if we want to represent which of four possible gears a car is in (park, drive, reverse, or neutral), we need only two bits: Park could be represented by 00, drive by 01, reverse by 10, and neutral by 11. The actual mapping between bit combinations and the thing each combination represents is sometimes irrelevant (00 could be used to represent reverse, if you prefer), although sometimes the mapping can be meaningful and important, as we discuss in later sections of this chapter.

If we want to represent more than four things, we need more than two bits. For example, three bits can represent eight things because eight combinations of 0 and 1 can be made from three bits. Likewise, four bits can represent 16 things, five bits can represent 32 things, and so on. See **FIGURE 3.4**. In the figure, note that the bit combinations are simply counting in binary as you move down a column.

In general, n bits can represent 2^n things because 2^n combinations of 0 and 1 can be made from n bits. Every time we increase the number of available bits by 1, we double the number of things we can represent.

Let's turn the question around. How many bits do you need to represent, say, 25 unique things? Well, four bits wouldn't be enough because

Chapter 3: Data Representation

1 Bit	2 Bits	3 Bits	4 Bits	5 Bits
0	00	000	0000	00000
1	01	001	0001	00001
	10	010	0010	00010
	11	011	0011	00011
		100	0100	00100
		101	0101	00101
		110	0110	00110
		111	0111	00111
			1000	01000
			1001	01001
			1010	01010
			1011	01011
			1100	01100
			1101	01101
			1110	01110
			1111	01111
				10000
				10001
				10010
				10011
				10100
				10101
				10110
				10111
				11000
				11001
				11010
				11011
				11100
				11101
				11110
				11111

FIGURE 3.4 Bit combinations

four bits can represent only 16 things. We would have to use at least five bits, which would allow us to represent 32 things. Given that we need to represent only 25 things, some of the bit combinations would not have a valid interpretation.

Keep in mind that even though we may technically need only a certain minimum number of bits to represent a set of items, we may allocate more than that for the storage of data. There is a minimum number of bits that a computer architecture can address and move around at one time, and it is usually a power of 2, such as 8, 16, or 32 bits. Therefore, the minimum amount of storage given to any type of data is allocated in multiples of that value.

3.2 Representing Numeric Data

Numeric values are the most prevalent type of data used in a computer system. Unlike with other types of data, there may seem to be no need to come up with a clever mapping between binary codes and numeric data. Because binary is a number system, a natural relationship exists between the numeric data and the binary values that we store to represent them. This is true, in general, for positive integer data. The basic issues regarding integer conversions were covered in Chapter 2 in the general discussion of the binary system and its equivalence to other bases. However, we have other issues regarding the representation of numeric data to consider at this point. Integers are just the beginning in terms of numeric data. This section discusses the representation of negative and noninteger values.

Representing Negative Values

Aren't negative numbers just numbers with a minus sign in front? Perhaps. That is certainly one valid way to think about them. Let's explore the issue of negative numbers and discuss appropriate ways to represent them on a computer.

Signed-Magnitude Representation

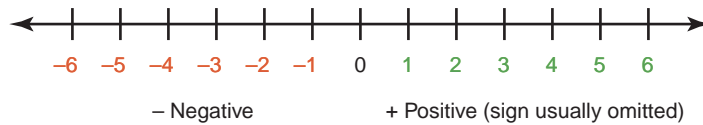
You have used the **signed-magnitude representation** of numbers since you first learned about negative numbers in grade school. In the traditional decimal system, a sign (+ or -) is placed before a number's value, although the positive sign is often assumed. The sign represents the ordering, and the digits represent the magnitude of the number. The classic number line

Signed-magnitude representation

Number representation in which the sign represents the ordering of the number (negative and positive) and the value represents the magnitude

Chapter 3: Data Representation

looks something like this, in which a negative sign means that the number is to the left of zero and the positive number is to the right of zero:



Performing addition and subtraction with signed integer numbers can be described as moving a certain number of units in one direction or another. To add two numbers, you find the first number on the scale and move in the direction of the sign of the second as many units as specified. Subtraction is done in a similar way, moving along the number line as dictated by the sign and the operation. In grade school, you soon graduated to doing addition and subtraction without using the number line.

There is a problem with the signed-magnitude representation: There are two representations of zero—plus zero and minus zero. The idea of a negative zero doesn't necessarily bother us; we just ignore it. However, two representations of zero within a computer can cause unnecessary complexity, so other representations of negative numbers are used. Let's examine another alternative.

Fixed-Sized Numbers

If we allow only a fixed number of values, we can represent numbers as just integer values, where half of them represent negative numbers. The sign is determined by the magnitude of the number. For example, if the maximum number of decimal digits we can represent is two, we can let 1 through 49 be the positive numbers 1 through 49 and let 50 through 99 represent the negative numbers -50 through -1 . Let's take the number line and number the negative values on the top according to this scheme:



To perform addition within this scheme, you just add the numbers together and discard any carry. Adding positive numbers should be okay. Let's try adding a positive number and a negative number, a negative number and a positive number, and two negative numbers. These are shown in the

following table in signed-magnitude and in this scheme (the carries are discarded):

Signed-Magnitude	New Scheme
$\begin{array}{r} 5 \\ + - 6 \\ \hline - 1 \end{array}$	$\begin{array}{r} 5 \\ + 94 \\ \hline 99 \end{array}$
$\begin{array}{r} - 4 \\ + 6 \\ \hline 2 \end{array}$	$\begin{array}{r} 96 \\ + 6 \\ \hline 2 \end{array}$
$\begin{array}{r} - 2 \\ + - 4 \\ \hline - 6 \end{array}$	$\begin{array}{r} 98 \\ + 96 \\ \hline 94 \end{array}$

What about subtraction, using this scheme for representing negative numbers? The key is in the relationship between addition and subtraction: $A - B = A + (-B)$. We can subtract one number from another by adding the negative of the second to the first:

Signed-Magnitude	New Scheme	Add Negative
$\begin{array}{r} - 5 \\ - 3 \\ \hline - 8 \end{array}$	$\begin{array}{r} 95 \\ - 3 \\ \hline \end{array}$	$\begin{array}{r} 95 \\ + 97 \\ \hline 92 \end{array}$

In this example, we have assumed a fixed size of 100 values and kept our numbers small enough to use the number line to calculate the negative representation of a number. However, you can also use a formula to compute the negative representation:

Negative(I) = $10^k - I$, where k is the number of digits

Let's apply this formula to -3 in our two-digit representation:

$$-(3) = 10^2 - 3 = 97$$

What about a three-digit representation?

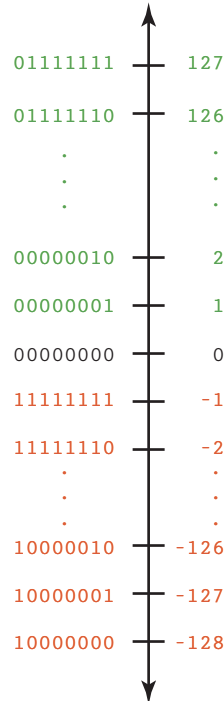
$$-(3) = 10^3 - 3 = 997$$

This representation of negative numbers is called the **ten's complement**. Although humans tend to think in terms of sign and magnitude to represent numbers, the complement strategy is actually easier in some ways when it comes to electronic calculations. Because we store everything in a modern computer in binary, we use the binary equivalent of the ten's complement, called the *two's complement*.

Ten's complement
A representation of negative numbers such that the negative of I is 10 raised to k minus I

Two's Complement

Let's assume that a number must be represented in eight bits: seven for the number and one for the sign. To more easily look at long binary numbers, we make the number line vertical:



Would the ten's complement formula work with the 10 replaced by 2? That is, could we compute the negative binary representation of a number using the formula $\text{negative}(I) = 2^k - I$? Let's try it and see:

$$-(2) = 2^8 - 2 = 256 - 2 = 254$$

Decimal 254 is 11111110 in binary, which corresponds to the value -2 in the number line above. The leftmost bit, the *sign bit*, indicates whether the number is negative or positive. If the leftmost bit is 0, the number is positive; if it is 1, the number is negative. Thus, $-(2)$ is 11111110.

There is an easier way to calculate the two's complement: invert the bits and add 1. That is, take the positive value and change all the 1 bits to 0 and all the 0 bits to 1, and then add 1.

$$\begin{array}{rcl}
 +2 & = & 00000010 \\
 \text{invert} & & 11111101 \\
 \text{add 1} & & \underline{00000001} \\
 -2 & = & 11111110
 \end{array}$$

Addition and subtraction are accomplished the same way as in ten's complement arithmetic:

$$\begin{array}{r} -127 \quad 10000001 \\ + \quad 1 \quad 00000001 \\ \hline -126 \quad 10000010 \end{array}$$

With this representation, the leftmost bit in a negative number is always a 1. Therefore, you can tell immediately whether a binary number in two's complement is negative or positive.

Number Overflow

Overflow occurs when the value that we compute cannot fit into the number of bits we have allocated for the result. For example, if each value is stored using eight bits, adding 127 to 3 would produce an overflow:

$$\begin{array}{r} 01111111 \\ + 00000011 \\ \hline 10000010 \end{array}$$

In our scheme, 10000010 represents -126 , not $+130$. If we were not representing negative numbers, however, the result would be correct.

Overflow is a classic example of the type of problems we encounter by mapping an infinite world onto a finite machine. No matter how many bits we allocate for a number, there is always the potential need to represent a number that doesn't fit. How overflow problems are handled varies by computer hardware and by the differences in programming languages.

Overflow A situation where a calculated value cannot fit into the number of digits reserved for it

Representing Real Numbers

In computing, we call all noninteger values (that can be represented) *real* values. For our purposes here, we define a real number as a value with a potential fractional part. That is, real numbers have a whole part and a fractional part, either of which may be zero. For example, some real numbers in base 10 are 104.32, 0.999999, 357.0, and 3.14159.

As we explored in Chapter 2, the digits represent values according to their position, and those position values are relative to the base. To the left of the decimal point, in base 10, we have the ones position, the tens position, the hundreds position, and so forth. These position values come from raising the base value to increasing powers (moving from the decimal point to the left). The positions to the right of the decimal point work the same way, except that the powers are negative. So the positions to the

Radix point The dot that separates the whole part from the fractional part in a real number in any base

Floating point A representation of a real number that keeps track of the sign, mantissa, and exponent

right of the decimal point are the tenths position (10^{-1} or one tenth), the hundredths position (10^{-2} or one hundredth), and so forth.

In binary, the same rules apply but the base value is 2. Since we are not working in base 10, the decimal point is referred to as a **radix point**, a term that can be used in any base. The positions to the right of the radix point in binary are the halves position (2^{-1} or one half), the quarters position (2^{-2} or one quarter), and so forth.

How do we represent a real value in a computer? We store the value as an integer and include information showing where the radix point is. That is, any real value can be described by three properties: the sign (positive or negative; the mantissa, which is made up of the digits in the value with the radix point assumed to be to the right; and the exponent, which determines how the radix point is shifted relative to the mantissa. A real value in base 10 can, therefore, be defined by the following formula:

$$\text{sign} * \text{mantissa} * 10^{\text{exp}}$$

The representation is called **floating point** because the number of digits is fixed but the radix point floats. When a value is in floating-point form, a positive exponent shifts the decimal point to the right, and a negative exponent shifts the decimal point to the left.

Let's look at how to convert a real number expressed in our usual decimal notation into floating-point notation. As an example, consider the number 148.69. The sign is positive, and two digits appear to the right of the decimal point. Thus the exponent is -2 , giving us $14869 * 10^{-2}$.

TABLE 3.1 shows other examples. For the sake of this discussion, we assume that only five digits can be represented.

How do we convert a value in floating-point form back into decimal notation? The exponent on the base tells us how many positions

to move the radix point. If the exponent is negative, we move the radix point to the left. If the exponent is positive, we move the radix point to the right. Apply this scheme to the floating-point values in Table 3.1.

Notice that in the last example in Table 3.1, we lose information. Because we are storing only five digits to represent the significant digits (the mantissa), the whole part of the value is not accurately represented in floating-point notation.

TABLE

3.1 Values in decimal notation and floating-point notation (five digits)

Real Value	Floating-Point Value
12001.00	$12001 * 10^0$
-120.01	$-12001 * 10^{-2}$
0.12000	$12000 * 10^{-5}$
-123.10	$-12310 * 10^{-2}$
155555000.00	$15555 * 10^4$

Likewise, a binary floating-point value is defined by the following formula:

$$\text{sign} * \text{mantissa} * 2^{\text{exp}}$$

Note that only the base value has changed. Of course, in this scheme the mantissa would contain only binary digits. To store a floating-point number in binary on a computer, we can store the three values that define it. For example, according to one common standard, if we devote 64 bits to the storage of a floating-point value, we use 1 bit for the sign, 11 bits for the exponent, and 52 bits for the mantissa. Internally, this format is taken into account whenever the value is used in a calculation or is displayed.

But how do we get the correct value for the mantissa if the value is not a whole number? In Chapter 2, we discussed how to change a natural number from one base to another. Here we have shown how real numbers are represented in a computer, using decimal examples. We know that all values are represented in binary in the computer. How do we change the fractional part of a decimal value to binary?

To convert a whole value from base 10 to another base, we divide by the new base, recording the remainder as the next digit to the left in the result and continuing to divide the quotient by the new base until the quotient becomes zero. Converting the fractional part is similar, but we *multiply* by the new base rather than dividing. The carry from the multiplication becomes the next digit to the right in the answer. The fractional part of the result is then multiplied by the new base. The process continues until the fractional part of the result is zero. Let's convert .75 to binary.

$$.75 * 2 = 1.50$$

$$.50 * 2 = 1.00$$

Thus, .75 in decimal is .11 in binary. Let's try another example.

$$.435 * 2 = 0.870$$

$$.870 * 2 = 1.740$$

$$.740 * 2 = 1.480$$

$$.480 * 2 = 0.960$$

$$.960 * 2 = 1.920$$

$$.920 * 2 = 1.840$$

...

Thus, .435 is 011011 . . . in binary. Will the fractional part ever become zero? Keep multiplying it out and see.

Now let's go through the entire conversion process by converting 20.25 in decimal to binary. First we convert 20.

$$\begin{array}{r} 10 \\ 2 \overline{)20} \\ \underline{20} \\ 0 \end{array}$$

$$\begin{array}{r} 5 \\ 2 \overline{)10} \\ \underline{10} \\ 0 \end{array}$$

$$\begin{array}{r} 2 \\ 2 \overline{)5} \\ \underline{4} \\ 1 \end{array}$$

$$\begin{array}{r} 1 \\ 2 \overline{)2} \\ \underline{2} \\ 0 \end{array}$$

$$\begin{array}{r} 0 \\ 2 \overline{)1} \\ \underline{0} \\ 1 \end{array}$$

20 in binary is 10100. Now we convert the fractional part:

$$.25 * 2 = 0.50$$

$$.50 * 2 = 1.00$$

Thus 20.25 in decimal is 10100.01 in binary.

Scientific notation is a term with which you may already be familiar, so we mention it here. Scientific notation is a form of floating-point representation in which the decimal point is kept to the right of the leftmost digit. That is, there is one whole number. In many programming languages, if you print out a large real value without specifying how to print it, the value is printed in scientific notation. Because exponents could not be printed in early machines, an "E" was used instead. For example, "12001.32708" would be written as "1.200132708E+4" in scientific notation.

Scientific notation An alternative floating-point representation

3.3 Representing Text

A text document can be decomposed into paragraphs, sentences, words, and ultimately individual characters. To represent a text document in digital form, we simply need to be able to represent every possible character

that may appear. The document is the continuous (analog) entity, and the separate characters are the discrete (digital) elements that we need to represent and store in computer memory.

At this point, we should distinguish between the basic idea of representing text and the more involved concept of word processing. When we create a document in a word processing program such as Microsoft® Word, we can specify all kinds of formatting: fonts, margins, tabs, color, and so on. Such programs also let us add art, equations, and other elements. This extra information is stored along with the rest of the text so that the document can be displayed and printed the way you want it. The core issue, however, is the way we represent the characters themselves; therefore, those techniques remain our focus at this point.

There are a finite number of characters to represent. The general approach for representing characters is to list all of them and then assign a binary string to each character. For example, to store a particular letter, we store the appropriate bit string.

So which characters do we need to represent? The English language includes 26 letters. But uppercase and lowercase letters have to be treated separately, so that's really 52 unique characters. Punctuation characters also have to be represented, as do the numeric digits (the actual characters '0', '1', through '9'). Even the space character must have a representation. And what about languages other than English? The list of characters we may want to represent starts to grow quickly once you begin to think about it. Keep in mind that, as we discussed earlier in this chapter, the number of unique things (characters, in this case) we want to represent determines how many bits we'll need to represent any one of them.

A **character set** is simply a list of characters and the codes used to represent each one. Several character sets have been used over the years, though a few have dominated. By agreeing to use a particular character set, computer manufacturers have made the processing of text data easier. We explore two character sets in the following sections: ASCII and Unicode.

The ASCII Character Set

ASCII stands for *American Standard Code for Information Interchange*. The ASCII character set originally used seven bits to represent each character, allowing for 128 unique characters. The eighth bit in each character byte was originally used as a *check bit*, which helped ensure proper data transmission. Later ASCII evolved so that all eight bits were used to represent a character. This eight-bit version is formally called the *Latin-1 Extended ASCII character set*. The extended ASCII set allows for 256

Character set A list of the characters and the codes used to represent each one

Character set maze

?

In 1960, an article in *Communications of the ACM* reported on a survey of character sets in use. Sixty distinct sets were described. Nine character sets, with differences in both content and ordering, were used in IBM's line of computers alone.¹

Left Digit(s)	Right Digit	ASCII									
		0	1	2	3	4	5	6	7	8	9
0		NUL	SOH	STX	ETX	EOT	ENQ	ACK	BEL	BS	HT
1		LF	VT	FF	CR	SO	SI	DLE	DC1	DC2	DC3
2		DC4	NAK	SYN	ETB	CAN	EM	SUB	ESC	FS	GS
3		RS	US	□	!	“	#	\$	%	&	'
4		()	*	+	,	-	.	/	0	1
5		2	3	4	5	6	7	8	9	:	;
6		<	=	>	?	@	A	B	C	D	E
7		F	G	H	I	J	K	L	M	N	O
8		P	Q	R	S	T	U	V	W	X	Y
9		Z	[\]	^	_	`	a	b	c
10		d	e	f	g	h	i	j	k	l	m
11		n	o	p	q	r	s	t	u	v	w
12		x	y	z	{		}	~	DEL		

FIGURE 3.5 The ASCII character set

characters and includes accented letters as well as several other special symbols. [FIGURE 3.5](#) shows the ASCII character set.

The codes in [Figure 3.5](#) are expressed as decimal numbers, but these values get translated to their binary equivalent for storage in the computer. Note that the ASCII characters have a distinct order based on the codes used to store them. Each character has a relative position (before or after) every other character. This property is helpful in several different ways. For example, note that both the uppercase and lowercase letters are in order. Therefore, we can use the character codes to help us put a list of words into alphabetical order.

The first 32 characters in the ASCII character chart do not have a simple character representation that you could print to the screen. These characters are reserved for special purposes, such as carriage return and tab. They are usually interpreted in special ways by whatever program is processing the data.

The Unicode Character Set

The extended version of the ASCII character set provides 256 characters, which is enough for English but not enough for international use. This limitation gave rise to the Unicode character set, which has a much stronger international influence.

The goal of the people who created Unicode is nothing less than to represent every character in every language used in the entire world, including all of the Asian ideograms. It also represents many special-purpose characters such as scientific symbols.

The Unicode character set is used by many programming languages and computer systems today. In general, the encoding uses 16 bits per character, but is flexible so that it can use more space per character if needed to represent additional characters. [FIGURE 3.6](#) shows a few characters from the non-ASCII portion of the Unicode character set.

For consistency, Unicode was designed to be a superset of ASCII. That is, the first 256 characters in the Unicode character set correspond exactly to the extended ASCII character set, including the codes used to represent them. Therefore, programs that assume ASCII values are unaffected even if the underlying system embraces the Unicode approach.

Text Compression

Alphabetic information (text) is a fundamental type of data. Therefore, it is important that we find ways to store and transmit text efficiently between one computer and another. The following sections examine three types of text compression:

- Keyword encoding
- Run-length encoding
- Huffman encoding

As we discuss later in this chapter, some of the ideas underlying these text compression techniques come into play when dealing with other types of data as well.

Keyword Encoding

Consider how often you use words such as “the,” “and,” “which,” “that,” and “what.” If these words took up less space (that is, had fewer characters), our documents would shrink in size. Even though the savings for

Code (Hex)	Character	Source
0041	A	English (Latin)
042F	Я	Russian (Cyrillic)
0E09	฿	Thai
13EA	Ꮖ	Cherokee
211E	℞	Letterlike symbols
21CC	⇌	Arrows
282F	⠆	Braille
345F	低	Chinese/Japanese/ Korean (common)

FIGURE 3.6 A few characters in the Unicode character set

Blood Type Confusion

It's said that Type O blood was actually named Type 0 (as in “zero”) blood initially, because of the lack of glycoproteins in its red blood cells. At some early point it was misread and is now and forever referred to as Type “Oh” blood. So essentially you could call that a typo!

The distinction between the letter O and the digit 0, as well as the distinction between an l (lowercase L) and the digit 1, has always been a challenge in computing, especially for programmers. Some character fonts make the distinction between these characters clearer than others, which helps minimize the confusion.

© Artur Debat/Getty Images; © Alan Dyer/Stocktrek Images/Getty Images

Bob Bemer

Bob Bemer became a fixture in computing circles in 1945. His résumé reads like a list of the most influential computing companies of the past half-century. He worked for Douglas Aircraft, RKO Radio Pictures, the Rand Corporation, Lockheed Aircraft, Marquardt Aircraft, Lockheed Missiles and Space, IBM, Univac Division of Sperry Rand, Bull General Electric (Paris), GTE, Honeywell, and finally his own software company, Bob Bemer Software.

The predominance of aircraft manufacturers on Bemer's résumé is not surprising because he studied mathematics and held a Certificate in Aeronautical Engineering from Curtiss-Wright Technical Institute (1941). In the early days of computing, aircraft manufacturers were pioneers in using computers in industry.

During his career, Bemer was active in programming language development. He developed FORTRANSIT, an early FORTRAN compiler. He was actively involved in the development of the COBOL language and the CODASYL language, an early approach to database modeling and management. In addition, he was responsible for authorizing funding for the development of SIMULA, a simulation language that introduced many object-oriented features.

However, Bemer is best known for his work on the ASCII computer code, which is the standard internal code for 8-bit PCs today. Early on, Bemer recognized that if computers were going to communicate with one another, they needed a standard code for transmitting textual information. Bemer made and

published a survey of more than 60 different computer codes, thus demonstrating a need for a standard code. He created the program of work for the standards committee, forced the U.S. standard code to correspond to the international code, wrote the bulk of the articles published about the code, and pushed for a formal registry of ASCII-alternate symbol and control sets to accommodate other languages.

Perhaps Bemer's most important contribution is the concept of an escape character. The escape character alerts the system processing the characters that the character(s) following the escape character change the standard meaning of the characters to follow.

The first version of a 16-bit code called *Unicode* was published in October 1991. Two factors drove the need for an enlarged code: 16-bit computer architecture was becoming popular, and the expansion of the Internet and the World Wide Web drove the need for a code that could directly include the world's alphabets. ASCII, however, has not gone away; it remains a subset of Unicode.

In May 2003, Bemer received the IEEE Computer Society's Computer Pioneer Award "for meeting the world's needs for variant character sets and other symbols, via ASCII, ASCII-alternate sets, and escape sequences."

Bob Bemer died on June 22, 2004, at his home on Possum Kingdom Lake in Texas.²



each word would be small, they are used so often in a typical document that the combined savings would add up quickly.

One fairly straightforward method of text compression is **keyword encoding**, in which frequently used words are replaced with a single character. To decompress the document, you reverse the process: You replace the single characters with the appropriate full word.

For example, suppose we used the following chart to encode a few words:

WORD	SYMBOL
as	^
the	~
and	+
that	\$
must	&
well	%
these	#

Let's encode the following paragraph:

The human body is composed of many independent systems, such as the circulatory system, the respiratory system, and the reproductive system. Not only must all systems work independently, but they must interact and cooperate as well. Overall health is a function of the well-being of separate systems, as well as how these separate systems work in concert.

The encoded paragraph is:

The human body is composed of many independent systems, such ^ ~ circulatory system, ~ respiratory system, + ~ reproductive system. Not only & each system work independently, but they & interact + cooperate ^ %. Overall health is a function of ~ %-being of separate systems, ^ % ^ how # separate systems work in concert.

There are a total of 352 characters in the original paragraph, including spaces and punctuation. The encoded paragraph contains 317 characters, resulting in a savings of 35 characters. The compression ratio for this example is 317/352 or approximately 0.9.

There are several limitations to keyword encoding. First, note that the characters we use to encode the keywords cannot be part of the original

Keyword encoding Replacing a frequently used word with a single character

Expensive night

If you stayed at a Holiday Inn, Holiday Inn Express, or Crowne Plaza hotel and checked out between October 24 and 26, 2002, you were likely to have been one of 26,000 people who were charged 100 times what they owed, such as \$6,500 to \$21,000 per night. A credit-processing error resulted in the decimal points being dropped.

text. If, for example, the ‘\$’ were part of the original paragraph, the resulting encoding would be ambiguous. We wouldn’t know whether ‘\$’ represented the word “that” or if it was the actual dollar-sign character. This limits the number of words we can encode as well as the nature of the text that we are encoding.

Also, note that the word “The” in the example is not encoded by the ‘~’ character because the word “The” and the word “the” contain different letters. Remember, the uppercase and lowercase versions of the same letter are different characters when it comes to storing them on a computer. We would have to use a separate symbol for “The” if we wanted to encode it—or employ a more sophisticated substitution scheme.

Finally, note that we would not gain anything by encoding words such as “a” and “I” because that would simply be replacing one character for another. The longer the word, the more compression we get per word. Unfortunately, the most frequently used words are often short. Of course, some documents use certain words more frequently than others depending on the subject matter. For example, we would have realized some nice savings if we had chosen to encode the word “system” in our example, but it might not be worth encoding in a general situation.

An extension of keyword encoding is to replace specific patterns of text with special characters. The encoded patterns are generally not complete words, but rather parts of words such as common prefixes and suffixes—“ex,” “ing,” and “tion,” for instance. An advantage of this approach is that patterns being encoded generally appear more often than whole words (because they occur in many different words). A disadvantage is that they are generally short patterns and, therefore, the replacement savings per word is small.

Run-Length Encoding

In some situations, a single character may be repeated over and over again in a long sequence. This type of repetition doesn’t generally take place in English text, but often occurs in large data streams, such as DNA sequences. A text compression technique called **run-length encoding** capitalizes on these situations. Run-length encoding is sometimes called *recurrence coding*.

In run-length encoding, a sequence of repeated characters is replaced by a *flag character*, followed by the repeated character, followed by a single digit that indicates how many times the character is repeated. For example, consider the following string of seven repeated ‘A’ characters:

AAAAAAA

Run-length encoding

Replacing a long series of a repeated character with a count of the repetition

If we use the ‘*’ character as our flag, this string would be encoded as

```
*A7
```

The flag character indicates that the series of three characters (including the flag) should be decoded into the appropriate repetitious string. All other text is treated regularly. Therefore, the encoded string

```
*n5*x9ccc*h6 some other text *k8eee
```

would be decoded into the following original text:

```
nnnnnxxxxxxxxccchhhhhh some other text kkkkkkkkeee
```

The original text contains 51 characters and the encoded string contains 35 characters, giving us a compression ratio in this example of 35/51, or approximately 0.68.

In this example the three repeated ‘c’ characters and the three repeated ‘e’ characters are not encoded. Because it takes three characters to encode a repetition sequence, it is not worth it to encode strings of two or three. In fact, in the case of two repeated characters, encoding would actually make the string longer!

Given that we are using one character for the repetition count, it seems that we can’t encode repetition lengths greater than nine. But keep in mind that each character is represented by a series of bits based on some character set. For example, the character ‘5’ is represented as ASCII value 53, which in an eight-bit binary string is 00110101. So, instead of interpreting the count character as an ASCII digit, we could interpret it as a binary number. We can then have repetition counts between 0 and 255, or even between 4 and 259, because runs of three or less are not represented.

Huffman Encoding

Another text compression technique, called **Huffman encoding**, is named after its creator, Dr. David Huffman. Why should the character “X,” which is seldom used in text, take up the same number of bits as the blank, which is used very frequently? Huffman codes address this question by using variable-length bit strings to represent each character. That is, a few characters may be represented by five bits, another few by six bits, yet another few by seven bits, and so forth. This approach is contrary to the idea of a character set, in which each character is represented by a fixed-length bit string (such as 8 or 16).

The idea behind this approach is that if we use only a few bits to represent characters that appear often and reserve longer bit strings for

Huffman encoding

Using a variable-length binary string to represent a character so that frequently used characters have short codes

Chapter 3: Data Representation

characters that don't appear often, the overall size of the document being represented is small.

For example, suppose we use the following Huffman encoding to represent a few characters:

Huffman Code	Character
00	A
01	E
100	L
110	O
111	R
1010	B
1011	D

Then the word "DOORBELL" would be encoded in binary as

1011110110111101001100100

If we used a fixed-size bit string to represent each character (say, 8 bits), then the binary form of the original string would be 8 characters times 8 bits, or 64 bits. The Huffman encoding for that string is 25 bits long, giving a compression ratio of 25/64, or approximately 0.39.

What about the decoding process? When we use character sets, we just take the bits in chunks of 8 or 16 bits to see what character the chunk represents. In Huffman encoding, with its variable-length codes, it seems as if we might get confused when trying to decode a string because we don't know how many bits we should include for each character. In fact, that potential source of confusion has been eliminated by the way the codes are created.

An important characteristic of any Huffman encoding is that no bit string used to represent a character is the prefix of any other bit string used to represent a character. Therefore, as we scan from left to right across a bit string, when we find a string that corresponds to a character, that must be the character it represents. It can't be part of a larger bit string.

For example, if the bit string

1010110001111011

is created with the previous table, it must be decoded into the word "BOARD." There is no other possibility.

So how is a particular set of Huffman codes created? The details of that process are a bit beyond the scope of this book, but let's discuss the underlying issue. Because Huffman codes use the shortest bit strings for the most common characters, we start with a table that lists the frequency of the characters we want to encode. Frequencies may come from counting characters in a particular document (352 E's, 248 S's, and so on) or from counting characters in a sample of text from a particular content area. A frequency table may also come from a general idea of how frequently letters occur in a particular language such as English. Using those values, we can construct a structure from which the binary codes can be read. The way the structure is created ensures that the most frequently used characters get the shortest bit strings.

3.4 Representing Audio Data

We perceive sound when a series of air compressions vibrate a membrane in our ear, which sends signals to our brain. Thus a sound is defined in nature by the wave of air that interacts with our eardrum. See [FIGURE 3.7](#). To represent a sound, we must somehow represent the appropriate sound wave.

A stereo sends an electrical signal to a speaker to produce sound. This signal is an analog representation of the sound wave. The voltage in the

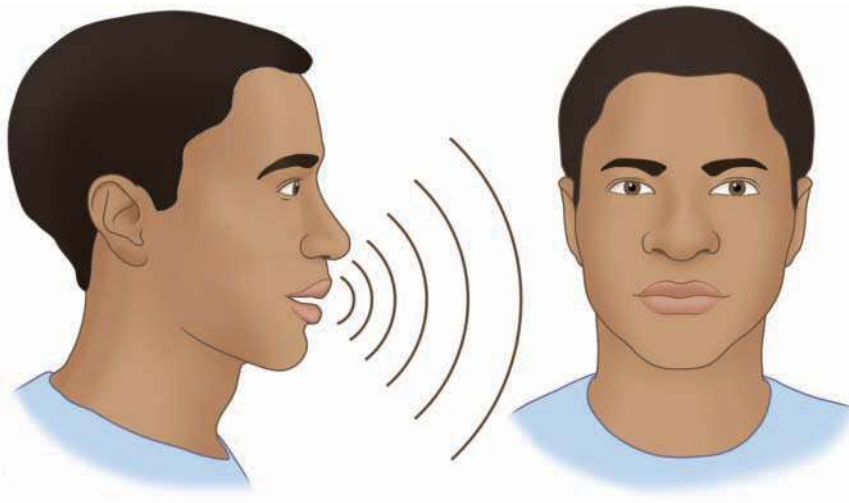


FIGURE 3.7 A sound wave vibrates our eardrums

signal varies in direct proportion to the sound wave. The speaker receives the signal and causes a membrane to vibrate, which in turn vibrates the air (creating a sound wave), which in turn vibrates the eardrum. The created sound wave should ideally be identical to the one that was captured initially, or at least good enough to please the listener.

To represent audio data on a computer, we must digitize the sound wave, somehow breaking it into discrete, manageable pieces. One way to accomplish this task is to actually digitize the analog representation of the sound. That is, we can take the electric signal that represents the sound wave and represent it as a series of discrete numeric values.

An analog signal varies in voltage continuously. To digitize the signal, we periodically measure the voltage of the signal and record the appropriate numeric value. This process is called *sampling*. Instead of a continuous signal, we end up with a series of numbers representing distinct voltage levels.

To reproduce the sound, we use the stored voltage values to create a new continuous electronic signal. The assumption is that the voltage levels in the original signal changed evenly between one stored voltage value and the next. If we take enough samples in a short period of time, that assumption is reasonable. But certainly the process of sampling can lose information, as shown in **FIGURE 3.8**.

In general, a sampling rate of around 40,000 times per second is enough to create a reasonable sound reproduction. If the sampling rate is much lower than that, the human ear begins to hear distortions. A higher sampling rate produces better-quality sound, but after a certain point the extra data is irrelevant because the human ear can't hear the difference. The overall result is affected by many factors, including the quality of the equipment, the type of sound, and the human listener.

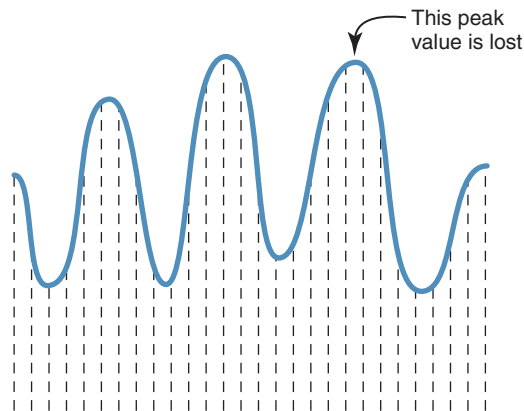


FIGURE 3.8 Sampling an audio signal

A vinyl record album is an analog representation of the sound wave. The needle of a record player (turntable) rides in the spiral groove of the album. The sides of this groove are not smooth—they vary in ways that are analogous to the sound wave they represent. The movement of the needle as it passes through the groove is converted into voltage to represent the sound.

In contrast, a compact disk (CD) stores audio information digitally. On the surface of the CD are microscopic pits that represent binary digits. A low-intensity laser is pointed at the disk. The laser light reflects strongly if the surface is smooth and reflects poorly if the surface is pitted. A receptor analyzes the reflection and produces the appropriate string of binary data, which represents the numeric voltage values that were stored when the signal was digitized. The signal is reproduced and sent to the speaker. See [FIGURE 3.9](#).

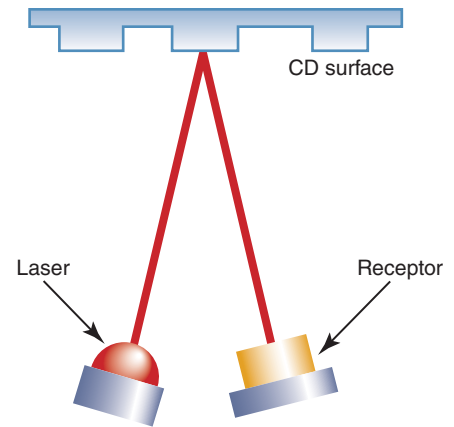


FIGURE 3.9 A CD player reading binary data

Audio Formats

Over the past few years, several formats for audio data have become popular, including WAV, AU, AIFF, VQF, and MP3. All of these formats are based on the storage of voltage values sampled from analog signals, but all recognize the details of the data in different ways and all use various compression techniques to one extent or another.

Currently, the dominant format for compressing audio data is MP3. The popularity of MP3 resulted mostly because it offered a stronger compression ratio than other formats available at the time. Other formats may prove more efficient in the future, but for now MP3 is the general favorite. In mid-1999, the term “MP3” was searched for more than any other term, and it is still going strong today. Let’s look at the details of the MP3 format a little more closely.

The MP3 Audio Format

MP3 is short for *MPEG-2, audio layer 3 file*. MPEG is an acronym for the *Moving Picture Experts Group*, which is an international committee that develops standards for digital audio and video compression.

MP3 employs both lossy and lossless compression. First, it analyzes the frequency spread and compares it to mathematical models of human psychoacoustics (the study of the interrelation between the ear and the brain). Then, it discards information that can’t be heard by humans.

Japan phone-answering competition

For more than fifty years, office workers across Japan have competed for the title of Japan’s best phone answerer. Women dominate the competition, using the high-pitched voices preferred by many Japanese businessmen. They are judged on their manners and business etiquette as well as their voices. How do you think modern computerized voices used on phone calls would compare?

Finally, the bit stream is compressed using a form of Huffman encoding to achieve additional compression.

Many software tools are available on the Web to help you create MP3 files. These tools generally require that the recording be stored in some other common format, such as WAV, before that data is converted into MP3 format, significantly reducing the file size.

A variety of MP3 players interpret and play MP3 files. An MP3 player can be purely software for an existing computer, or it can be a dedicated hardware device that stores and plays the files, such as the popular Apple iPod. Most MP3 players allow users to organize their files in several different ways and to display corresponding information and graphics during playback.

3.5 Representing Images and Graphics

Images such as photographs and graphics such as line drawings have common issues when it comes to their representation and compression. We first look at the general idea of representing color, then turn to the various techniques for digitizing and representing visual information.

Representing Color

Color is our perception of the various frequencies of light that reach the retinas of our eyes. Our retinas have three types of color photoreceptor cone cells that respond to different sets of frequencies. These photoreceptor categories correspond to the colors red, green, and blue. All other colors perceptible by the human eye can be made by combining various amounts of these three colors.

In a computer, color is often expressed as an RGB (red-green-blue) value, which is actually three numbers that indicate the relative contribution of each of these three primary colors. If each number in the triple is given on a scale of 0 to 255, then 0 means no contribution of that color and 255 means full contribution of that color. For example, an RGB value of (255, 255, 0) maximizes the contribution of red and green and minimizes the contribution of blue, which results in a bright yellow.

The concept of RGB values gives rise to a three-dimensional *color space*. **FIGURE 3.10** shows one way to display such a color space.

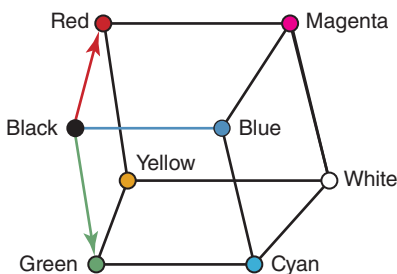


FIGURE 3.10 A three-dimensional color space

The amount of data that is used to represent a color is called the *color depth*. It is usually expressed in terms of the number of bits that are used to represent the color. *High color* indicates a 16-bit color depth. With this scheme, 5 bits are used for each number in an RGB value and the extra bit is sometimes used to represent transparency. *True color* indicates a 24-bit color depth. With this scheme, each number in an RGB value gets 8 bits, which gives the range of 0 to 255 for each. This results in the ability to represent more than 16.7 million unique colors.

The following chart shows a few true color RGB values and the colors they represent:

RGB VALUE			
Red	Green	Blue	Color
0	0	0	black
255	255	255	white
255	255	0	yellow
255	130	255	pink
146	81	0	brown
157	95	82	purple
140	0	0	maroon

The 24-bit true color values provide more colors than the human eye can distinguish. Furthermore, the monitors that display colors are restricted to a particular color depth. In older hardware in which monitor colors are reduced to, say, 256 colors, any color that is specified by a program is mapped into the closest color in the palette of colors that the hardware is capable of displaying. [FIGURE 3.11](#) shows such a restricted color

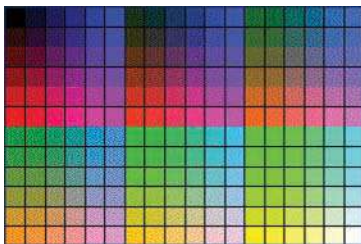


FIGURE 3.11 A restricted color palette

palette. When there are significant differences between the colors desired and the colors that can be displayed, the results are usually unsatisfactory. Thankfully, most modern monitors provide enough color range to greatly reduce these problems.

Digitized Images and Graphics

A photograph is an analog representation of an image. It is continuous across its surface, with shades of one color blending into another. Digitizing a picture is the act of representing it as a collection of individual dots called **pixels**, a term that stands for *picture elements*. Each pixel is composed of a single color. The number of pixels used to represent a picture is called the **resolution**. If enough pixels are used (high resolution) and are then presented in the proper order side by side, the human eye can be fooled into thinking it's viewing a continuous picture. **FIGURE 3.12** shows a digitized picture, with a small portion of it magnified to show the individual pixels.

The storage of image information on a pixel-by-pixel basis is called a **raster-graphics format**. Several popular raster-graphics file formats are currently in use, including bitmap (BMP), GIF, and JPEG.

A *bitmap file* is one of the most straightforward graphic representations. In addition to a few administrative details, a bitmap file contains the pixel color values of the image from left to right and from top to bottom. A bitmap file supports 24-bit true color, although usually the color depth can be specified to reduce the file size. Such a file may be compressed using run-length encoding.

Pixels Individual dots used to represent a picture; stands for *picture elements*

Resolution The number of pixels used to represent a picture

Raster-graphics format Storing image information pixel by pixel

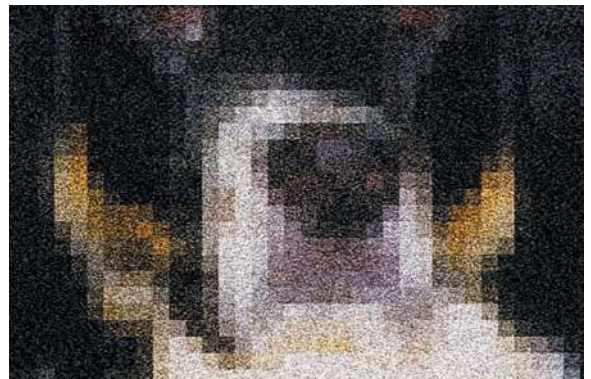


FIGURE 3.12 A digitized picture composed of many individual pixels

Courtesy of Amy Rose

Graphics Interchange Format (GIF), which was developed by CompuServe in 1987, limits the number of available colors in the image to 256. That is, a GIF image can be made up of only 256 colors, but each GIF image can be made up of a different set of 256 colors. This technique, called *indexed color*, results in smaller file sizes because there are fewer colors to reference. If even fewer colors are required, the color depth can usually be specified with fewer bits. GIF files are best used for graphics and images with few colors, and are therefore considered optimal for line art. A version of the GIF format allows for small animations to be defined by storing a series of images that a program such as a browser displays in succession.

The JPEG format is designed to exploit the nature of our eyes. Humans are more sensitive to gradual changes of brightness and color over distance than we are to rapid changes. Therefore, the data that the JPEG format stores averages out the color hues over short distances. This format is considered superior for photographic color images. A fairly complicated compression scheme can significantly reduce the resulting file sizes.

PNG (pronounced “ping”) stands for *Portable Network Graphics*. The designers of the PNG format wanted to improve upon, and ultimately replace, the GIF format. PNG images can usually achieve a greater compression than GIFs, while offering a much wider range of color depths. An extension to the PNG specification (called APNG) allows for animated images that are similar to animated GIFs.

The file that represents an image may contain **metadata** about the image. In general, metadata is data about data; that is, it is data that describes the purpose and/or structure of other data, and possibly helps the user manage that data.

In the case of an image, metadata might include the date and time the image was created, and details of the size and resolution of the image. If the image is a photo, it may contain the location where the photo was taken (longitude and latitude). It also may contain the creator of the image and whether it is copyrighted.

Vector Representation of Graphics

Vector graphics is another technique for representing images. Instead of assigning colors to pixels as we do in raster graphics, a vector-graphics format describes an image in terms of lines and geometric shapes. A vector graphic is a series of commands that describe a line’s direction, thickness, and color. The file sizes produced with these formats tend to be small because every pixel does not have to be accounted for. The complexity

Metadata Data about data

Vector graphics
Representation of an image in terms of lines and shapes

Einstein describes the telegraph

“You see, wire telegraph is a kind of very, very long cat,” explained Albert Einstein. “You pull its tail in New York and his head is meowing in Los Angeles....And radio operates exactly the same way: You send signals here, they receive them there. The only difference is that there is no cat.”

How do you think Einstein would describe the Web?

of the image, such as the number of items in the picture, determines the file size.

A raster graphic such as a GIF must be encoded multiple times to account for different sizes and proportions. By contrast, vector graphics can be resized mathematically, and these changes can be calculated dynamically as needed.

However, vector graphics images are not good for representing real-world images. JPEG images are far superior in that regard, but vector graphics images are good for line art and cartoon-style drawings.

There are two dominant vector-graphics formats in use today: *Adobe Flash* and *Scalable Vector Graphics (SVG)*. Flash images are stored in a binary format and require a special editor to create. SVG images are represented in plain text and therefore can be created and modified using a regular text editor as well as using a drawing program. The SVG specification was developed by the World Wide Web Consortium and is well-supported by all major browsers.

3.6 Representing Video

Video information is one of the most complex types of information to capture, compress, and still get a result that makes sense to the human eye. Video clips contain the equivalent of many still images, each of which must be compressed. The Web is full of video clips with widely varying levels of quality. Some of the quality issues depend on the sophistication of video compression techniques, which are referred to as *video codecs*.

Video codec Methods used to shrink the size of a movie

Temporal compression

Movie compression technique based on differences between consecutive frames

Video Codecs

Codec stands for *COmpressor/DECompressor*. A **video codec** refers to the methods used to shrink the size of a movie so that it can be played on a computer or over a network. Almost all video codecs use lossy compression to minimize the huge amounts of data associated with video. The goal, therefore, is not to lose information that affects the viewer's senses.

Most codecs are block oriented, meaning that each frame of a video is divided into rectangular blocks. The various codecs differ in how the blocks are encoded. Some video codecs are accomplished completely in software, whereas others require special hardware.

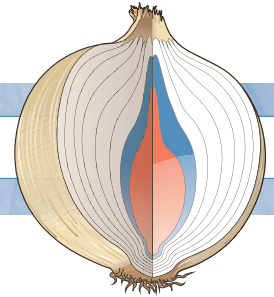
Video codecs employ two types of compression: temporal and spatial. **Temporal compression** looks for differences between consecutive frames.

If most of an image in two frames hasn't changed, why should we waste space by duplicating all of the similar information? A *keyframe* is chosen as the basis on which to compare the differences, and its entire image is stored. For consecutive images, only the changes (called *delta frames*) are stored. Temporal compression is effective in video that changes little from frame to frame, such as a scene that contains little movement.

Spatial compression removes redundant information within a frame. This problem is essentially the same as the one we face when compressing still images. Spatial video compression often groups pixels into blocks (rectangular areas) that have the same color, such as a portion of a clear blue sky. Instead of storing each pixel, the color and the coordinates of the area are stored instead. This idea is similar to run-length encoding.

Various video codecs are popular today, including Sorenson, Cinepak, MPEG, and Real Video. The details of how these codecs represent and compress video are beyond the scope of this book.

Spatial compression
Movie compression technique based on the same compression techniques used for still images



© Artur Debat/Getty Images, © Alan Dyer/Stocktrek Images/Getty Images

SUMMARY

Computers are multimedia devices that manipulate data varying in form from numbers to graphics to video. Because a computer can manipulate only binary values, all forms of data must be represented in binary form. Data is classified as being either continuous (analog) or discrete (digital).

Integer values are represented by their binary equivalent using one of several techniques for representing negative numbers, such as a signed-magnitude or two's complement. Real numbers are represented by a triple made up of the sign, the digits in the number, and an exponent that specifies the radix point.

A character set is a list of alphanumeric characters and the codes that represent each character. The most commonly used character set today is Unicode (16 bits for each character), which has ASCII as a subset. The 8-bit ASCII set is sufficient for English but not for other (or multiple) languages. There are various ways for compressing text so that it takes less space to store it or less time to transmit it from one machine to another.

Audio information is represented as digitized sound waves. Color is represented by three values that represent the contributions of red, blue, and green, respectively. Two basic techniques are used for representing pictures, bitmaps, and vector graphics. Video is broken up into a series of still images, each of which is represented as a picture.



ETHICAL ISSUES

The Fallout from Snowden's Revelations

Edward Snowden worked as a computer specialist for the Central Intelligence Agency (CIA) and a contractor for the National Security Agency (NSA). In June of 2012, he leaked a large number of classified documents to several media outlets. These documents revealed the operational details of a global surveillance program of which NSA was a partner. This surveillance program collected massive amounts of metadata—that is, data about data—from leading Internet companies.

James Clapper, the U.S. director of national intelligence, explained that George W. Bush first authorized this Internet spying just after 9/11. The program was disclosed in 2005 and was replaced by extensions of the Foreign Intelligence Surveillance Act (FISA), which allowed the FISA Court to grant warrants for the collection of bulk data; that is, metadata.³

After the public outcry resulting from Snowden's revelations, a presidential advisory committee was formed, which submitted 46 recommendations for changes to the NSA's operations.⁴ President Obama announced in early 2014 that the U.S. government would scale back its eavesdropping on foreign leaders and its vast collection of Americans' phone data. The numbers and times of phone calls made by every American will still be collected, but access to the metadata will be more restricted. Gaining access to the collection will require approval from the FISA Court.⁵

In August 2013, Edward Snowden was granted one year of asylum in Russia, renewable annually. In 2017, Moscow officials announced he can remain in Russia through at least 2020. He has been variously called a criminal, a hero, a traitor, and a patriot.

© Artur Debat/Getty Images; © Alan Dyer/Stocktrek Images/Getty Images

KEY TERMS

Analog data
Bandwidth
Character set
Compression ratio
Data
Data compression
Digital data

Digitize
Floating point
Huffman encoding
Information
Keyword encoding
Lossless compression
Lossy compression

KEY TERMS (CONTINUED)

Multimedia
 Overflow
 Pixels
 Pulse-code modulation
 Radix point
 Raster-graphics format
 Reclock
 Resolution

Run-length encoding
 Scientific notation
 Signed-magnitude representation
 Spatial compression
 Temporal compression
 Ten's complement
 Vector graphics
 Video codec

EXERCISES

For Exercises 1–20, mark the answers true or false as follows:

- A. True
 - B. False
1. *Lossless compression* means the data can be retrieved without losing any of the original information.
 2. A computer represents information in an analog form.
 3. A computer must use the binary number system to represent information.
 4. A digital signal represents one of two values at any point in time.
 5. Four bits can be used to represent 32 unique things.
 6. The signed-magnitude representation of numbers has two representations for zero.
 7. Overflow occurs when the value that we compute cannot fit into the number of bits we have allocated for the result.
 8. In the ASCII character set, no distinction is made between uppercase and lowercase letters.
 9. The Unicode character set includes all of the characters in the ASCII character set.
 10. Keyword encoding replaces frequently used words with a single character.
 11. Run-length encoding is very good at compressing English text.
 12. Huffman encoding uses variable-length binary strings to represent characters.
 13. An audio signal is digitized by sampling it at regular intervals.
 14. A CD stores audio information in a binary format.
 15. The MP3 audio format discards information that cannot be heard by humans.

EXERCISES (CONTINUED)

16. An RGB value represents a color using three numeric values.
17. Indexed color increases the number of colors that can be used in an image, and thus increases the file size.
18. Bitmap, GIF, and JPEG are all examples of raster-graphics formats.
19. Vector graphics represent images in terms of lines and geometric shapes.
20. A keyframe is used in temporal compression to represent the changes from one frame to another.

For Exercises 21–26, choose the correct term from the following list.

- A. Signed-magnitude representation
 - B. Radix point
 - C. Frequency of use
 - D. Sampling
 - E. Analog
 - F. Digital
21. _____ data is a continuous representation of information.
 22. The representation for numbers you've used since grade school is called _____.
 23. If the number base is other than base 10, we call the decimal point the _____.
 24. _____ data is a discrete representation of information.
 25. Huffman codes are created based on the _____ of the character.

26. An audio signal is digitized by _____ its value at regular intervals.

Exercises 27–79 are problems or short-answer questions.

27. Why is data compression an important topic today?
28. What is the difference between lossless and lossy data compression?
29. Why do computers have difficulty with analog information?
30. Is a clock with a sweeping second hand an analog device or a digital device? Explain.
31. What does it mean to digitize something?
32. What is pulse-code modulation?
33. How many things can be represented with
 - a. Four bits?
 - b. Five bits?
 - c. Six bits?
 - d. Seven bits?
34. Although you have been computing simple arithmetic operations since the second grade, take the following quick test to confirm that you thoroughly understand operations on signed integers. Evaluate the following expressions where W is 17, X is 28, Y is -29 , and Z is -13 .

a. $X + Y$	b. $X + W$
c. $Z + W$	d. $Y + Z$
e. $W - Z$	f. $X - W$
g. $Y - W$	h. $Z - Y$

EXERCISES (CONTINUED)

35. Use the base-10 number line to prove the solutions to the following operations, where A is 5 and B is -7 .
- $A + B$
 - $A - B$
 - $B + A$
 - $B - A$
36. Given a fixed-sized number scheme where k in the formula for the ten's complement is 6 (see page 63), answer the following questions.
- How many positive integers can be represented?
 - How many negative integers can be represented?
 - Draw the number line showing the three smallest and largest positive numbers, the three smallest and largest negative numbers, and zero.
37. Use the number line in Exercise 36(c) to calculate the following expressions, where A is -499999 and B is 3.
- $A + B$
 - $A - B$
 - $B + A$
 - $B - A$
38. Use the formula for the ten's complement to calculate the following numbers in the scheme described on page 63.
- 35768
 - -35768
 - -444455
 - -123456
39. In calculating the ten's complement in Exercise 38, did you have trouble borrowing from so many zeros? Such calculations are error prone. There is a trick you can use that makes the calculation easier and thus less prone to errors: Subtract from all 9s and then add 1. A number subtracted from all 9s is called the *nine's complement* of the number.
- Prove that the nine's complement of a number plus one is equal to the ten's complement of the same number.
 - Use the nine's complement plus one to calculate the values in Exercise 38(b), (c), and (d).
 - Which did you find easier to use, the direct calculation of the ten's complement or the nine's complement plus one? Justify your answer.
40. Evaluate the following expressions, where A is 11111110 and B is 00000010, using the two's complement.
- $A + B$
 - $A - B$
 - $B - A$
 - $-B$
 - $-(-A)$
41. Is the two's complement of a number always a negative number? Explain.
42. Devise a number system based on base 11.
- Draw the number line.
 - Show examples of addition and subtraction.
 - Develop a representation of negative numbers based on the eleven's complement.
43. Convert the rules for subtraction in a signed-magnitude system to the algorithm format.

EXERCISES (CONTINUED)

44. Convert the following real numbers to binary (five binary places).
 - a. 0.50
 - b. 0.26
 - c. 0.10
45. Convert the following real numbers to octal (five octal places).
 - a. 0.50
 - b. 0.26
 - c. 0.10
46. Can fractional values be visually converted between octal and binary and back? Explain.
47. How many bits would be needed to represent a character set containing 45 characters? Why?
48. How can the decimal number 175.23 be represented as a sign, mantissa, and exponent?
49. What is the main difference between the ASCII and Unicode character sets?
50. Create a keyword encoding table that contains a few simple words. Rewrite a paragraph of your choosing using this encoding scheme. Compute the compression ratio you achieve.
51. How would the following string of characters be represented using run-length encoding? What is the compression ratio?
AAAABBBCCCCCCCCDDDD hi there EEEEEEEEEFF
52. What does the code *X5*A9 represent using run-length encoding?

53. Given the following Huffman encoding table, decipher the bit strings that follow.

HUFFMAN CODE	CHARACTER
00	A
11	E
010	T
0110	C
0111	L
1000	S
1011	R
10010	O
10011	I
101000	N
101001	F
101010	H
101011	D

- a. 1101110001011
 - b. 0110101010100101011111000
 - c. 10100100101000010001000010100110110
 - d. 1010001001010100010001110100100011
54. How do humans perceive sound?
 55. Is a stereo speaker an analog device or a digital device? Explain.
 56. What is an RGB value?
 57. What does color depth indicate?
 58. How does pixel resolution affect the visual impact of an image?
 59. Explain temporal video compression.
 60. Describe a situation in which spatial video compression would be effective.

EXERCISES (CONTINUED)

61. Define *sampling* as it relates to digitizing sound waves.
62. Which produces better sound quality, higher sampling rates or lower sampling rates?
63. What is the sampling rate per second that is enough to create reasonable sound reproduction?
64. Do vinyl record albums and compact disks record sound in the same way?
65. What does an RGB value of (130, 0, 255) mean?
66. What color does an RGB value of (255, 255, 255) represent?
67. What is resolution?
68. The GIF format uses which technique?
69. What are GIF files best for?
70. How are the various video codecs alike?
71. How are the various video codecs different?
72. Name two types of video compression.
73. What do we call the perception of the various frequencies of light that reach the retinas of our eyes?
74. What is the best format for photographic color images?
75. What are the techniques called that shrink the sizes of movies?
76. What is the technique in which an application supports only a certain number of specific colors, creating a palette from which to choose?
77. What is the format that describes an image in terms of lines and geometric shapes?
78. Which format stores information on a pixel-by-pixel basis?
79. What is the difference between high color and true color?

THOUGHT QUESTIONS

1. What are some advantages of using a common (standardized) character set? What are some disadvantages?
2. When converting whole numbers from one base to another, we divide by the new base. When converting fractional parts from one base to another, we multiply by the new base. Can positional notation be used to explain these algorithms?
3. Technology is changing rapidly. What changes have occurred in data compression since this book was written?
4. Where is Edward Snowden now? How do you think his actions will be characterized in the future?

Laying the Groundwork

- 1 The Big Picture

The Information Layer

- 2 Binary Values and Number Systems
- 3 Data Representation

The Hardware Layer

- 4 Gates and Circuits
- 5 Computing Components

The Programming Layer

- 6 Low-Level Programming Languages and Pseudocode
- 7 Problem Solving and Algorithms
- 8 Abstract Data Types and Subprograms
- 9 Object-Oriented Design and High-Level Programming Languages

The Operating Systems Layer

- 10 Operating Systems
- 11 File Systems and Directories

The Applications Layer

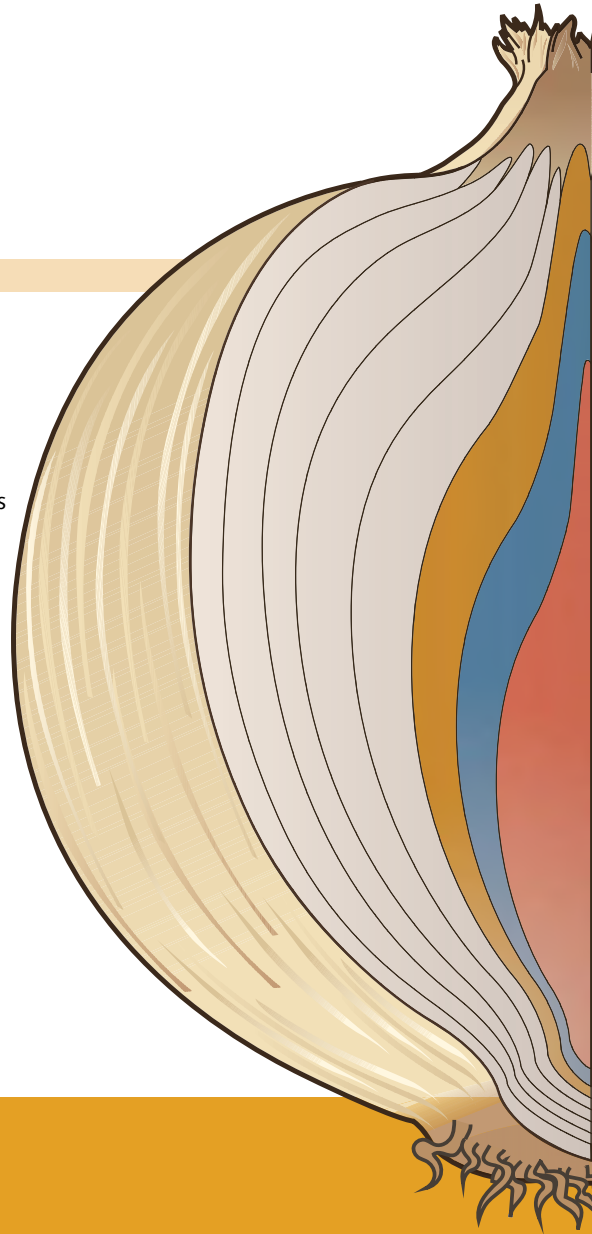
- 12 Information Systems
- 13 Artificial Intelligence
- 14 Simulation, Graphics, Gaming, and Other Applications

The Communications Layer

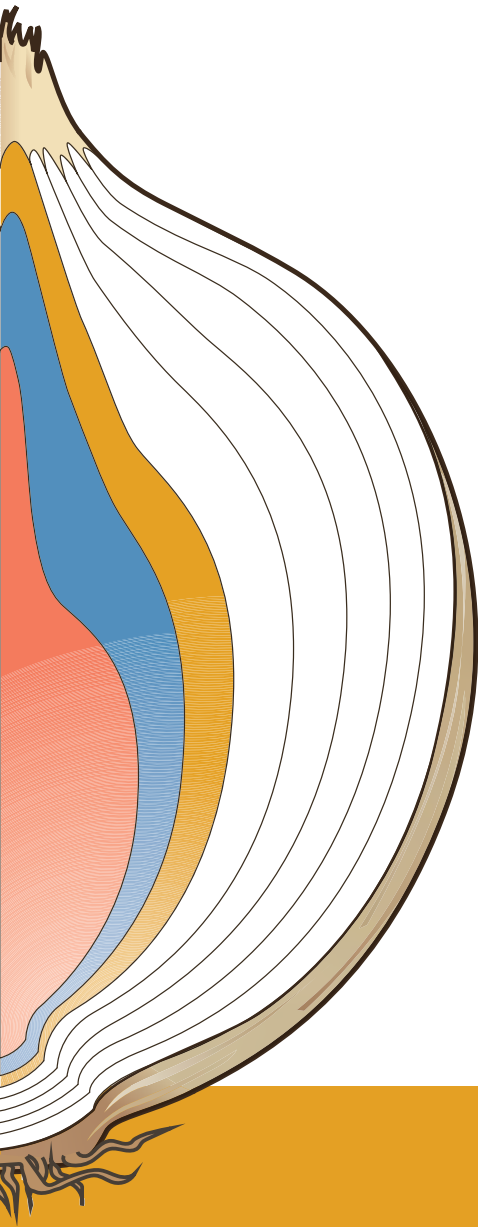
- 15 Networks
- 16 The World Wide Web
- 17 Computer Security

In Conclusion

- 18 Limitations of Computing



THE HARDWARE LAYER



4

GATES AND CIRCUITS

Computers are electronic devices; the most fundamental hardware elements of a computer control the flow of electricity. In a very primitive sense, we use technology to harness the power of a lightning bolt, bending it to our will so that we can perform calculations and make decisions. This chapter dances the fine line between computer science and electrical engineering, examining the most basic hardware elements in a computer.

In Chapter 2, we looked at number systems in general and at the binary number system in particular. As we saw in Chapter 3, the binary number system is of special interest because it is used to represent data in a computer. In this chapter, we explore how computers use electrical signals to represent and manipulate those binary values.

GOALS

After studying this chapter, you should be able to:

- identify the basic gates and describe the behavior of each.
- describe how gates are implemented using transistors.
- combine basic gates into circuits.
- describe the behavior of a gate or circuit using Boolean expressions, truth tables, and logic diagrams.
- compare and contrast a half adder and a full adder.
- describe how a multiplexer works.
- explain how an S-R latch operates.
- describe the characteristics of the four generations of integrated circuits.

Gate A device that performs a basic operation on electrical signals, accepting one or more input signals and producing a single output signal

Circuit A combination of interacting gates designed to accomplish a specific logical function

Boolean algebra

A mathematical notation for expressing two-valued logical functions

Logic diagram

A graphical representation of a circuit; each type of gate has its own symbol

Truth table A table showing all possible input values and the associated output values

4.1 Computers and Electricity

Any given electronic signal has a level of voltage. As we mentioned in the last chapter, we distinguish between the two values of interest (binary 0 and 1) by the voltage level of a signal. In general, a voltage level in the range of 0 to 2 volts is considered “low” and is interpreted as a binary 0. A signal in the range of 2 to 5 volts is considered “high” and is interpreted as a binary 1. Signals in a computer are constrained to be within one range or the other.

A **gate** is a device that performs a basic operation on electrical signals. It accepts one or more input signals and produces a single output signal. Several types of gates exist; we examine the six most fundamental types in this chapter. Each type of gate performs a particular logical function.

Gates are combined into **circuits** to perform more complicated tasks. For example, circuits can be designed to perform arithmetic and to store values. In a circuit, the output value of one gate often serves as the input value for one or more other gates. The flow of electricity through a circuit is controlled by the carefully designed logic of the interacting gates.

Three different, but equally powerful, notational methods are used to describe the behavior of gates and circuits:

- Boolean expressions
- Logic diagrams
- Truth tables

We examine all three types of representation during our discussion of gates and circuits.

The English mathematician George Boole invented a form of algebra in which variables and functions take on only one of two possible values (0 and 1). This algebra is appropriately called **Boolean algebra**. Expressions in this algebraic notation are an elegant and powerful way to demonstrate the activity of electrical circuits. Specific operations and properties in Boolean algebra allow us to define and manipulate circuit logic using a mathematical notation. Boolean expressions will come up again in our discussions of the programming layer in Chapters 6 through 9.

A **logic diagram** is a graphical representation of a circuit. Each type of gate is represented by a specific graphical symbol. By connecting those symbols in various ways, we can visually represent the logic of an entire circuit.

A **truth table** defines the function of a gate by listing all possible input combinations that the gate could encounter, along with corresponding output. We can design more complex truth tables with sufficient rows and columns to show how entire circuits perform for any set of input values.

© Artur Debat/Getty Images; © Alan Dyer/Stocktrek Images/Getty Images

George Boole¹

Boolean algebra is named for its inventor, English mathematician George Boole, born in 1815. His father, a tradesman, began teaching him mathematics at an early age. But Boole was initially more interested in classical literature, languages, and religion—interests he maintained throughout his life. By the time he was 20, he had taught himself French, German, and Italian. He was well versed in the writings of Aristotle, Spinoza, Cicero, and Dante, and wrote several philosophical papers himself.

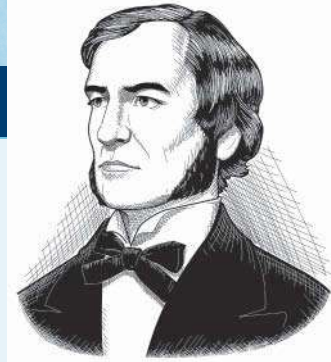
At 16 he took a position as a teaching assistant in a private school to help support his family. His work there plus a second teaching job left him little time to study. A few years later, he opened a school and began to learn higher mathematics on his own. In spite of his lack of formal training, his first scholarly paper was published in the *Cambridge Mathematical Journal* when he was just 24. In 1849, he was appointed professor of mathematics at Queen's College in Cork, Ireland. He became chair of mathematics and spent the rest of his career there. Boole went on to publish more than 50 papers and several major works before he died in 1864, at the peak of his career.

Boole's *The Mathematical Analysis of Logic* was published in 1847. It would eventually form the basis for the development of digital computers. In the book, Boole set forth the formal axioms of logic (much like the axioms of

geometry) on which the field of symbolic logic is built. Boole drew on the symbols and operations of algebra in creating his system of logic. He associated the value 1 with the universal set (the set representing everything in the universe) and the value 0 with the empty set, and restricted his system to these quantities. He then defined operations that are analogous to subtraction, addition, and multiplication.

In 1854, Boole published *An Investigation of the Laws of Thought; on Which Are Founded the Mathematical Theories of Logic and Probabilities*. This book described theorems built on his axioms of logic and extended the algebra to show how probabilities could be computed in a logical system. Five years later, Boole published *Treatise on Differential Equations*, followed by *Treatise on the Calculus of Finite Differences*. The latter is one of the cornerstones of numerical analysis, which deals with the accuracy of computations.

Boole received little recognition and few honors for his work. Given the importance of Boolean algebra in modern technology, it is hard to believe that his system of logic was not taken seriously until the early twentieth century. George Boole was truly one of the founders of computer science.



?

What is nanoscience?

Nanoscience and nanotechnology are the study and application of extremely small things:

- There are 25,400,000 nanometers in an inch.
- A sheet of newspaper is about 100,000 nanometers thick.
- If a marble were a nanometer, one meter would be the size of the Earth.²

4.2 Gates

The gates in a computer are sometimes referred to as *logic gates* because each performs just one logical function. That is, each gate accepts one or more input values and produces a single output value. Because we are dealing with binary information, each input and output value is either 0, corresponding to a low-voltage signal, or 1, corresponding to a high-voltage signal. The type of gate and the input values determine the output value.

Let's examine the processing of the following six types of gates. We then show how they can be combined into circuits to perform arithmetic operations.

- NOT
- AND
- OR
- XOR
- NAND
- NOR

In this book we have colorized the logic diagram symbols for each gate to help you keep track of the various types. When we examine full circuits with many gates, the colors will help you distinguish among them. In the real world, however, logic diagrams are typically black and white, and the gates are distinguished only by their shape.

NOT Gate

A NOT gate accepts one input value and produces one output value.

FIGURE 4.1 shows a NOT gate represented in three ways: as a Boolean expression, as its logical diagram symbol, and through a truth table. In each representation, the variable *A* represents the input signal, which is either 0 or 1. The variable *X* represents the output signal, whose value (0 or 1) is determined by the value of *A*.

By definition, if the input value for a NOT gate is 0, the output value is 1; if the input value is 1, the output is 0. A NOT gate is sometimes referred to as an *inverter* because it inverts the input value.

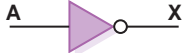
Boolean Expression	Logic Diagram Symbol	Truth Table						
$X = A'$		<table border="1"> <thead> <tr> <th>A</th> <th>X</th> </tr> </thead> <tbody> <tr> <td>0</td> <td>1</td> </tr> <tr> <td>1</td> <td>0</td> </tr> </tbody> </table>	A	X	0	1	1	0
A	X							
0	1							
1	0							

FIGURE 4.1 Representations of a NOT gate

In Boolean expressions, the NOT operation is represented by the ' mark after the value being negated. Sometimes this operation is shown as a horizontal bar over the value being negated. In the Boolean expression in Figure 4.1, X is assigned the value determined by applying the NOT operation to input value A. In such an *assignment statement*, the variable on the left of the equal sign takes on the value of the expression on the right-hand side. Assignment statements are discussed further in Chapter 6.

The logic diagram symbol for a NOT gate is a triangle with a small circle (called an *inversion bubble*) on the end. The input and output are shown as lines flowing into and out of the gate. Sometimes these lines are labeled, though not always.

The truth table in Figure 4.1 shows all possible input values for a NOT gate as well as the corresponding output values. Because there is only one input signal to a NOT gate, and that signal can be only a 0 or a 1, there are only two possibilities for the column labeled A in the truth table. The column labeled X shows the output of the gate, which is the inverse of the input. Note that of the three representations, only the truth table actually defines the behavior of the gate for all situations.

These three notations are just different ways of representing the same thing. For example, the result of the Boolean expression

$0'$

is always 1, and the result of the Boolean expression

$1'$

is always 0. This behavior is consistent with the values shown in the truth table.

AND Gate

FIGURE 4.2 depicts an AND gate. Unlike a NOT gate, which accepts one input signal, an AND gate accepts two input signals. The values of both input signals determine what the output signal will be. If the two

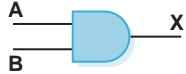
Boolean Expression	Logic Diagram Symbol	Truth Table															
$X = A \cdot B$		<table border="1"> <thead> <tr> <th>A</th> <th>B</th> <th>X</th> </tr> </thead> <tbody> <tr> <td>0</td> <td>0</td> <td>0</td> </tr> <tr> <td>0</td> <td>1</td> <td>0</td> </tr> <tr> <td>1</td> <td>0</td> <td>0</td> </tr> <tr> <td>1</td> <td>1</td> <td>1</td> </tr> </tbody> </table>	A	B	X	0	0	0	0	1	0	1	0	0	1	1	1
A	B	X															
0	0	0															
0	1	0															
1	0	0															
1	1	1															

FIGURE 4.2 Representations of an AND gate

Chapter 4: Gates and Circuits

input values for an AND gate are both 1, the output is 1; otherwise, the output is 0.

The AND operation in Boolean algebra is expressed using a single dot (\cdot). Sometimes an asterisk ($*$) is used to represent this operator. Often the operator itself is assumed. For example, $A \cdot B$ is often written AB .

Because there are two inputs and two possible values for each input, four possible combinations of 1 and 0 can be provided as input to an AND gate. Therefore, four situations can occur when the AND operator is used in a Boolean expression:

$$0 \cdot 0 \text{ equals } 0$$

$$0 \cdot 1 \text{ equals } 0$$

$$1 \cdot 0 \text{ equals } 0$$

$$1 \cdot 1 \text{ equals } 1$$

Likewise, the truth table showing the behavior of the AND gate has four rows, showing all four possible input combinations. The output column of the truth table is consistent with results of these Boolean expressions.

OR Gate

FIGURE 4.3 shows an OR gate. Like the AND gate, the OR gate has two inputs. If both input values are 0, the output value is 0; otherwise, the output is 1.

The Boolean algebra OR operation is expressed using a plus sign ($+$). The OR gate has two inputs, each of which can be one of two values. Thus, as with an AND gate, there are four input combinations and therefore four rows in the truth table.

XOR Gate

The XOR, or *exclusive* OR, gate is shown in **FIGURE 4.4**. An XOR gate produces a 0 if its two inputs are the same, and a 1 otherwise. Note the


Boolean Expression	Logic Diagram Symbol	Truth Table															
$X = A + B$		<table border="1"> <thead> <tr> <th>A</th> <th>B</th> <th>X</th> </tr> </thead> <tbody> <tr> <td>0</td> <td>0</td> <td>0</td> </tr> <tr> <td>0</td> <td>1</td> <td>1</td> </tr> <tr> <td>1</td> <td>0</td> <td>1</td> </tr> <tr> <td>1</td> <td>1</td> <td>1</td> </tr> </tbody> </table>	A	B	X	0	0	0	0	1	1	1	0	1	1	1	1
A	B	X															
0	0	0															
0	1	1															
1	0	1															
1	1	1															

FIGURE 4.3 Representations of an OR gate

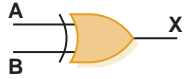
Boolean Expression	Logic Diagram Symbol	Truth Table															
$X = A \oplus B$		<table border="1"> <thead> <tr> <th>A</th> <th>B</th> <th>X</th> </tr> </thead> <tbody> <tr> <td>0</td> <td>0</td> <td>0</td> </tr> <tr> <td>0</td> <td>1</td> <td>1</td> </tr> <tr> <td>1</td> <td>0</td> <td>1</td> </tr> <tr> <td>1</td> <td>1</td> <td>0</td> </tr> </tbody> </table>	A	B	X	0	0	0	0	1	1	1	0	1	1	1	0
A	B	X															
0	0	0															
0	1	1															
1	0	1															
1	1	0															

FIGURE 4.4 Representations of an XOR gate

difference between the XOR gate and the OR gate; they differ in only one input situation. When both input signals are 1, the OR gate produces a 1 and the XOR produces a 0.

Sometimes the regular OR gate is referred to as the *inclusive* OR, because it produces a 1 if either or both of its inputs is a 1. The XOR produces a 1 only if its inputs are mixed (one 1 and one 0). Think of the XOR gate as saying, “When I say *or*, I mean one or the other, not both.”

The Boolean algebra symbol \oplus is sometimes used to express the XOR operation. In addition, the XOR operation can be expressed using the other operators; we leave that as an exercise.

Note that the logic diagram symbol for the XOR gate is just like the symbol for an OR gate except that it has an extra curved line connecting its input signals.

NAND and NOR Gates

The NAND gate is shown in [FIGURE 4.5](#) and the NOR gate is shown in [FIGURE 4.6](#). Each accepts two input values. The NAND and NOR gates are essentially the opposites of the AND and OR gates, respectively. That is, the output of a NAND gate is the same as if you took the output of an AND gate and put it through an inverter (a NOT gate).

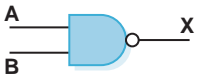
Boolean Expression	Logic Diagram Symbol	Truth Table															
$X = (A \cdot B)'$		<table border="1"> <thead> <tr> <th>A</th> <th>B</th> <th>X</th> </tr> </thead> <tbody> <tr> <td>0</td> <td>0</td> <td>1</td> </tr> <tr> <td>0</td> <td>1</td> <td>1</td> </tr> <tr> <td>1</td> <td>0</td> <td>1</td> </tr> <tr> <td>1</td> <td>1</td> <td>0</td> </tr> </tbody> </table>	A	B	X	0	0	1	0	1	1	1	0	1	1	1	0
A	B	X															
0	0	1															
0	1	1															
1	0	1															
1	1	0															

FIGURE 4.5 Representations of a NAND gate


Boolean Expression	Logic Diagram Symbol	Truth Table															
$X = (A + B)'$		<table border="1"> <thead> <tr> <th>A</th> <th>B</th> <th>X</th> </tr> </thead> <tbody> <tr> <td>0</td> <td>0</td> <td>1</td> </tr> <tr> <td>0</td> <td>1</td> <td>0</td> </tr> <tr> <td>1</td> <td>0</td> <td>0</td> </tr> <tr> <td>1</td> <td>1</td> <td>0</td> </tr> </tbody> </table>	A	B	X	0	0	1	0	1	0	1	0	0	1	1	0
A	B	X															
0	0	1															
0	1	0															
1	0	0															
1	1	0															

FIGURE 4.6 Representations of a NOR gate

No specific symbols are used to express the NAND and NOR operations in Boolean algebra. Instead, we rely on their definitions to express the concepts. That is, the Boolean algebra expression for NAND is the negation of an AND operation. Likewise, the Boolean algebra expression for NOR is the negation of an OR operation.

The logic diagram symbols for the NAND and NOR gates are the same as those for the AND and OR gates, except that the NAND and NOR symbols use an inversion bubble (to indicate the negation). Compare the output columns for the truth tables for the AND and NAND gates. They are opposites, when you look at them row by row. The same is true for the OR and NOR gates.

Review of Gate Processing

We've looked at six specific types of gates. It may seem to be a difficult task to keep them straight and remember how they all work—but that probably depends on how you think about it. We definitely don't encourage you to try to memorize truth tables. The processing of these gates can be described briefly in general terms. If you think of them in that way, you can produce the appropriate truth table any time you need it.

Let's review the processing of each gate. Some of these descriptions are stated in terms of which input values cause the gate to produce a 1 as output; in any other case, the gate produces a 0.

- A NOT gate inverts its single input value.
- An AND gate produces 1 if both input values are 1.
- An OR gate produces 1 if one or the other or both input values are 1.
- An XOR gate produces 1 if one or the other (but not both) input values are 1.
- A NAND gate produces the opposite results of an AND gate.
- A NOR gate produces the opposite results of an OR gate.



The tenth strand

Computing Curricula 1991, a report by a joint task force of the Association for Computing Machinery (ACM) and the Institute of Electrical and Electronics Engineers (IEEE), gave recommendations for the design of bachelor's degree curricula in computer science. Although the report had a section entitled "Social and Professional Context," which stated that students need "to understand the basic cultural, social, legal, and ethical issues inherent in computing," the study of ethics was not one of the nine subject areas, or strands. By 2001, social and professional issues was included as a topic area in computing education and called the *tenth strand*.

With these general processing rules in mind, all that's left is to remember the Boolean operators and the logic diagram symbols. Keep in mind that several logic diagram symbols are variations on other logic diagram symbols. Also, remember that the coloring of the gates in this book is meant to help you to keep track of the various gate types; traditionally, they are simply black-and-white diagrams.

Gates with More Inputs

Gates can be designed to accept three or more input values. A three-input AND gate, for example, produces an output of 1 only if all input values are 1. A three-input OR gate produces an output of 1 if any input value is 1. These definitions are consistent with the two-input versions of these gates. **FIGURE 4.7** shows an AND gate with three input signals.

There are 2^3 , or 8, possible input combinations for a gate with three inputs. Recall from Chapter 3 that there are 2^n combinations of 1 and 0 for n distinct input values. This number determines how many rows appear in the truth table.

For the logic diagram symbol, we simply add a third input signal to the original symbol. For a Boolean expression, we repeat the AND operation to represent the third value.

4.3 Constructing Gates

Before we examine how gates are connected to form circuits, let's examine, at an even more basic level, how a gate is constructed to control the flow of electricity.

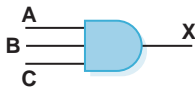
Boolean Expression	Logic Diagram Symbol	Truth Table																																				
$X = A \cdot B \cdot C$		<table border="1"> <thead> <tr> <th>A</th> <th>B</th> <th>C</th> <th>X</th> </tr> </thead> <tbody> <tr> <td>0</td> <td>0</td> <td>0</td> <td>0</td> </tr> <tr> <td>0</td> <td>0</td> <td>1</td> <td>0</td> </tr> <tr> <td>0</td> <td>1</td> <td>0</td> <td>0</td> </tr> <tr> <td>0</td> <td>1</td> <td>1</td> <td>0</td> </tr> <tr> <td>1</td> <td>0</td> <td>0</td> <td>0</td> </tr> <tr> <td>1</td> <td>0</td> <td>1</td> <td>0</td> </tr> <tr> <td>1</td> <td>1</td> <td>0</td> <td>0</td> </tr> <tr> <td>1</td> <td>1</td> <td>1</td> <td>1</td> </tr> </tbody> </table>	A	B	C	X	0	0	0	0	0	0	1	0	0	1	0	0	0	1	1	0	1	0	0	0	1	0	1	0	1	1	0	0	1	1	1	1
A	B	C	X																																			
0	0	0	0																																			
0	0	1	0																																			
0	1	0	0																																			
0	1	1	0																																			
1	0	0	0																																			
1	0	1	0																																			
1	1	0	0																																			
1	1	1	1																																			

FIGURE 4.7 Representations of a three-input AND gate

Transistor A device that acts either as a wire or a resistor, depending on the voltage level of an input signal

Semiconductor Material such as silicon that is neither a good conductor nor a good insulator

?

Transistor roles

In addition to a transistor operating as a switch, it can also be used as a regulator of the voltage that passes through it. When used in this way, it serves as an amplifier.

Transistors

A gate uses one or more transistors to establish how the input values map to the output value. A **transistor** is a device that acts, depending on the voltage level of the input signal, either as a wire that conducts electricity or as a resistor that blocks the flow of electricity. A transistor has no moving parts, yet it acts like a switch. It is made of a **semiconductor** material, which is neither a particularly good conductor of electricity (such as copper) nor a particularly good insulator (such as rubber). Usually silicon is used to create transistors.

In Chapter 1, we mentioned that the invention of transistors, which occurred in 1947 at Bell Labs, changed the face of technology, ushering in the second generation of computer hardware. Before the advent of transistors, digital circuits used vacuum tubes, which dissipated a great deal of heat and often failed, requiring replacement. Transistors are much smaller than vacuum tubes and require less energy to operate. They can switch states in a few nanoseconds. Computing, as we know it today, is largely due to the invention of the transistor.

Before tackling the details of transistors, let's discuss some basic principles of electricity. An electrical signal has a source, such as a battery or an outlet in your wall. If the electrical signal is *grounded*, it is allowed to flow through an alternative route to the ground (literally), where it can do no harm. A grounded electrical signal is pulled down, or reduced, to 0 volts.

A transistor has three terminals: a source, a base, and an emitter. The emitter is typically connected to a ground wire, as shown in **FIGURE 4.8**. For computers, the source produces a high voltage value, approximately 5 volts. The base value regulates a gate that determines whether the connection between the source and ground is made. If the source signal is grounded, it is pulled down to 0 volts. If the base does not ground the source signal, it stays high.

An output line is usually connected to the source line. If the source signal is pulled to the ground by the transistor, the output signal is low, representing a binary 0. If the source signal remains high, so does the output signal, representing a binary 1.

The transistor is either on, producing a high-output signal, or off, producing a low-output signal. This output is determined by the base electrical signal. If the base signal is high (close to a +5 voltage), the source signal is grounded, which turns the transistor off. If the base signal is low (close to a 0 voltage), the source signal stays high, and the transistor is on.

Now let's see how a transistor is used to create various types of gates. It turns out that, because of the way a transistor works, the easiest gates

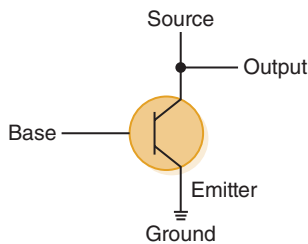


FIGURE 4.8 The connections of a transistor

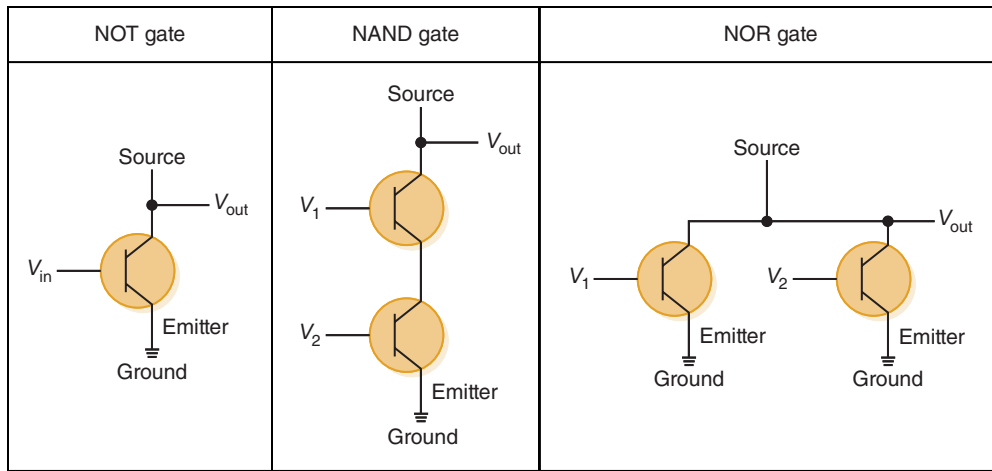


FIGURE 4.9 Constructing gates using transistors

to create are the NOT, NAND, and NOR gates. FIGURE 4.9 shows how these gates can be constructed using transistors.

The diagram for the NOT gate is essentially the same as our original transistor diagram. It takes only one transistor to create a NOT gate. The signal V_{in} represents the input signal to the NOT gate. If it is high, the source is grounded and the output signal V_{out} is low. If V_{in} is low, the source is not grounded and V_{out} is high. Thus the input signal is inverted, which is exactly what a NOT gate does.

The NAND gate requires two transistors. The input signals V_1 and V_2 represent the input to the NAND gate. If both input signals are high, the source is grounded and the output V_{out} is low. If either input signal is low, however, one transistor or the other keeps the source signal from being grounded and the output is high. Therefore, if V_1 or V_2 or both carry a low signal (binary 0), the output is a 1. This is consistent with the processing of a NAND gate.

The construction of a NOR gate also requires two transistors. Once again, V_1 and V_2 represent the input to the gate. This time, however, the transistors are not connected in series. The source connects to each transistor separately. If either transistor allows the source signal to be grounded, the output is 0. Therefore, the output is high (binary 1) only when both V_1 and V_2 are low (binary 0), which is what we want for a NOR gate.

An AND gate produces output that is exactly opposite of the NAND output of a gate. Therefore, to construct an AND gate, we simply pass the output of a NAND gate through an inverter (a NOT gate). That's why

AND gates are more complicated to construct than NAND gates: They require three transistors, two for the NAND and one for the NOT. The same reasoning can be applied to understand the relationship between NOR and OR gates.

4.4 Circuits

Combinational circuit

A circuit whose output is solely determined by its input values

Sequential circuit

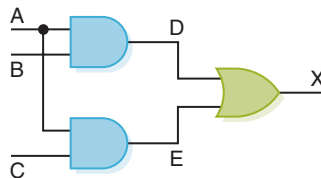
A circuit whose output is a function of its input values and the current state of the circuit

Now that we know how individual gates work and how they are constructed, let's examine how we combine gates to form circuits. Circuits can be classified into two general categories. In a **combinational circuit**, the input values explicitly determine the output. In a **sequential circuit**, the output is a function of the input values as well as the existing state of the circuit. Thus sequential circuits usually involve the storage of information. Most of the circuits we examine in this chapter are combinational circuits, although we briefly mention sequential memory circuits.

As with gates, we can describe the operations of entire circuits using three notations: Boolean expressions, logic diagrams, and truth tables. These notations are different, but equally powerful, representation techniques.

Combinational Circuits

Gates are combined into circuits by using the output of one gate as the input for another gate. For example, consider the following logic diagram of a circuit:



The output of the two AND gates is used as the input to the OR gate. The input value A is used as input to both AND gates. The dot indicates that two lines are connected. If the intersection of two crossing lines does not have a dot, you should think of one as “jumping over” the other without affecting each other.

What does this logic diagram mean? Well, let's work backward to see what it takes to get a particular result. For the final output X to be 1, either D must be 1 or E must be 1. For D to be 1, A and B must both be 1.

For E to be 1, both A and C must be 1. Both E and D may be 1, but that isn't necessary. Examine this circuit diagram carefully; make sure that this reasoning is consistent with your understanding of the types of gates used.

Now let's represent the processing of this entire circuit using a truth table:

A	B	C	D	E	X
0	0	0	0	0	0
0	0	1	0	0	0
0	1	0	0	0	0
0	1	1	0	0	0
1	0	0	0	0	0
1	0	1	0	1	1
1	1	0	1	0	1
1	1	1	1	1	1

Because there are three inputs to this circuit, eight rows are required to describe all possible input combinations. Intermediate columns show the intermediate values (D and E) in the circuit.

Finally, let's express this same circuit using Boolean algebra. A circuit is a collection of interacting gates, so a Boolean expression to represent a circuit is a combination of the appropriate Boolean operations. We just have to put the operations together in the proper form to create a valid Boolean algebra expression. In this circuit, there are two AND expressions. The output of each AND operation is input to the OR operation. Thus this circuit is represented by the following Boolean expression (in which the AND operator is assumed):

$$(AB + AC)$$

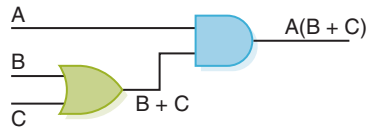
When we write truth tables, it is often better to label columns using these kinds of Boolean expressions rather than arbitrary variables such as D, E, and X. That makes it clear what each column represents. In fact, we can use Boolean expressions to label our logic diagrams as well, eliminating the need for intermediate variables altogether.

Now let's go the other way: Let's take a Boolean expression and draw the corresponding logic diagram and truth table. Consider the following Boolean expression:

$$A(B + C)$$

Chapter 4: Gates and Circuits

In this expression, the OR operation is applied to input values B and C. The result of that operation is used as input, along with A, to an AND operation, producing the final result. The corresponding circuit diagram is:



Once again, we complete our series of representations by expressing this circuit as a truth table. As in the previous example, there are three input values, so there are eight rows in the truth table:

A	B	C	B + C	A(B + C)
0	0	0	0	0
0	0	1	1	0
0	1	0	1	0
0	1	1	1	0
1	0	0	0	0
1	0	1	1	1
1	1	0	1	1
1	1	1	1	1

Pick a row from this truth table and follow the logic of the circuit diagram to make sure the final results are consistent. Try it with a few rows to get comfortable with the process of tracing the logic of a circuit.

Now compare the final result column in this truth table to the truth table for the previous example. They are identical. We have just demonstrated **circuit equivalence**. That is, both circuits produce exactly the same output for each input value combination.

In fact, this situation demonstrates an important property of Boolean algebra called the *distributive law*:

$$A(B + C) = AB + AC$$

Circuit equivalence

The same output for each corresponding input-value combination for two circuits

That's the beauty of Boolean algebra: It allows us to apply provable mathematical principles to design logical circuits. The following chart shows a few of the properties of Boolean algebra:

PROPERTY	AND	OR
Commutative	$AB = BA$	$A + B = B + A$
Associative	$(AB)C = A(BC)$	$(A + B) + C = A + (B + C)$
Distributive	$A(B + C) = (AB) + (AC)$	$A + (BC) = (A + B)(A + C)$
Identity	$A1 = A$	$A + 0 = A$
Complement	$A(A') = 0$	$A + (A') = 1$
De Morgan's law	$(AB)' = A' \text{ OR } B'$	$(A + B)' = A'B'$

These properties are consistent with our understanding of gate processing as well as with the truth table and logic diagram representations. For instance, the commutative property, in plain English, says that the order of the input signals doesn't matter, which is true. (Verify it using the truth tables of individual gates.) The complement property says that if we put a signal and its inverse through an AND gate, we are guaranteed to get 0, but if we put a signal and its inverse through an OR gate, we are guaranteed to get 1.

There is one very famous—and useful—theorem in Boolean algebra called *De Morgan's law*. This law states that the NOT operator applied to the AND of two variables is equal to the NOT applied to each of the two variables with an OR between. That is, inverting the output of an AND gate is equivalent to inverting the individual signals first and then passing them through an OR gate:

$$(AB)' = A' \text{ OR } B'$$

The second part of the law states that the NOT operator applied to the OR of two variables is equal to the NOT applied to each of the two variables with an AND between. Expressed in circuit terms, this means that inverting the output of an OR gate is equivalent to inverting both signals first and then passing them through an AND gate:

$$(A + B)' = A'B'$$

De Morgan's law and other Boolean algebra properties provide a formal mechanism for defining, managing, and evaluating logical circuit designs.

De Morgan's Law, named for Augustus De Morgan

?

De Morgan, a contemporary of George Boole, was the first professor of mathematics at the University of London in 1828, where he continued to teach for 30 years. He wrote elementary texts on arithmetic, algebra, trigonometry, and calculus as well as papers on the possibility of establishing a logical calculus and the fundamental problem of expressing thought by means of symbols. De Morgan did not discover the law bearing his name, but he is credited with formally stating it as it is known today.³

Adder An electronic circuit that performs an addition operation on binary values

Half adder A circuit that computes the sum of two bits and produces the appropriate carry bit

Adders

Perhaps the most basic operation a computer can perform is to add two numbers together. At the digital logic level, this addition is performed in binary. Chapter 2 discusses this process in depth. These types of addition operations are carried out by special circuits called, appropriately, **adders**.

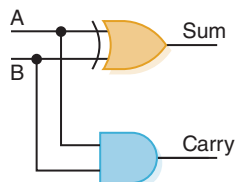
Like addition in any base, the result of adding two binary digits could potentially produce a *carry value*. Recall that $1 + 1 = 10$ in base 2. A circuit that computes the sum of two bits and produces the correct carry bit is called a **half adder**.

Let's consider all possibilities when adding two binary digits A and B: If both A and B are 0, the sum is 0 and the carry is 0. If A is 0 and B is 1, the sum is 1 and the carry is 0. If A is 1 and B is 0, the sum is 1 and the carry is 0. If both A and B are 1, the sum is 0 and the carry is 1. This yields the following truth table:

A	B	Sum	Carry
0	0	0	0
0	1	1	0
1	0	1	0
1	1	0	1

In this case, we are actually looking for two output results, the sum and the carry. As a consequence, our circuit has two output lines.

If you compare the sum and carry columns to the output of the various gates, you see that the sum corresponds to the XOR gate and the carry corresponds to the AND gate. Thus the following circuit diagram represents a half adder:



Test this diagram by assigning various combinations of input values and determining the two output values produced. Do the results follow the rules of binary arithmetic? They should. Now compare your results to the corresponding truth table. They should match the results there as well.

What about the Boolean expression for this circuit? Because the circuit produces two distinct output values, we represent it using two Boolean expressions:

$$\text{sum} = A \oplus B$$

$$\text{carry} = AB$$

Note that a half adder does not take into account a possible carry value *into* the calculation (carry-in). That is, a half adder is fine for adding two single digits, but it cannot be used as is to compute the sum of two binary values with multiple digits each. A circuit called a **full adder** takes the carry-in value into account.

We can use two half adders to make a full adder. How? Well, the input to the sum must be the carry-in and the sum from adding the two input values. That is, we add the sum from the half adder to the carry-in. Both of these additions have a carry-out. Could both of these carry-outs be 1, yielding yet another carry? Fortunately, no. Look at the truth table for the half adder. There is no case where the sum and the carry are both 1.

FIGURE 4.10 shows the logic diagram and the truth table for the full adder. This circuit has three inputs: the original two digits (A and B) and the carry-in value. Thus the truth table has eight rows. We leave the corresponding Boolean expression as an exercise.

To add two 8-bit values, we can duplicate a full-adder circuit eight times. The carry-out from one place value is used as the carry-in to the next-highest place value. The value of the carry-in for the rightmost bit position is assumed to be zero, and the carry-out of the leftmost bit position is discarded (potentially creating an overflow error).

There are various ways to improve on the design of these adder circuits, but we do not explore them in any more detail in this text.

Full adder A circuit that computes the sum of two bits, taking an input carry bit into account

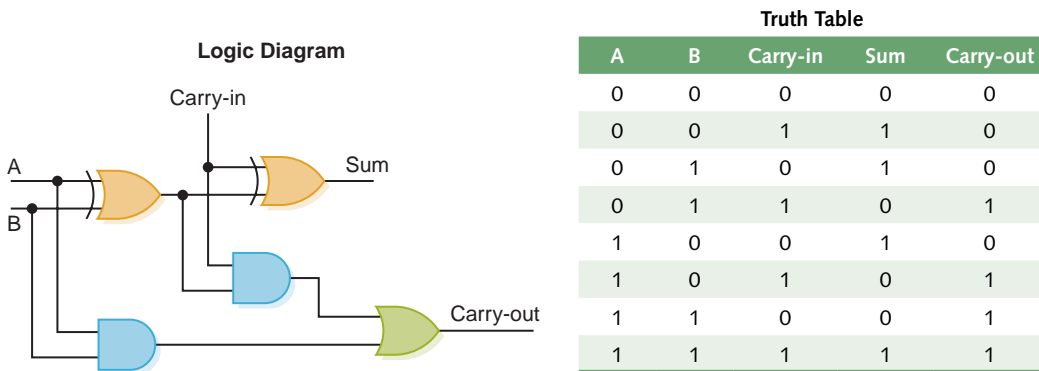


FIGURE 4.10 A full adder

Multiplexer A circuit that uses a few input control signals to determine which of several input data lines is routed to its output

?

Errors

While developing his first program, in about 1949, Maurice Wilkes said, “The realization came over me with full force that a good part of the remainder of my life was going to be spent in finding the errors in my own programs.”⁴

Multiplexers

A **multiplexer** (often referred to as a *mux*) is a general circuit that produces a single output signal. This output is equal to one of several input signals to the circuit. The multiplexer selects which input signal to use as an output signal based on the value represented by a few more input signals, called *select signals* or *select control lines*.

Let’s look at an example to clarify how a multiplexer works. **FIGURE 4.11** shows a block diagram of a mux. The control lines S0, S1, and S2 determine which of eight other input lines (D0 through D7) are routed to the output (F).

The values of the three control lines, taken together, are interpreted as a binary number, which determines which input line to route to the output. Recall from Chapter 2 that three binary digits can represent eight different values: 000, 001, 010, 011, 100, 101, 110, and 111. These values, which simply count in binary from 0 to 7, correspond to our output values D0 through D7. Thus, if S0, S1, and S2 are all 0, the input line D0 would be the output from the mux. If S0 is 1, S1 is 0, and S2 is 1, then D5 would be output from the mux.

The following truth table shows how the input control lines determine the output for this multiplexer:

The block diagram in Figure 4.11 hides a fairly complicated circuit that carries out the logic of a multiplexer. Such a circuit could be shown using eight three-input AND gates and one eight-input OR gate. We won’t get into the details of this circuit in this book.

S0	S1	S2	F
0	0	0	D0
0	0	1	D1
0	1	0	D2
0	1	1	D3
1	0	0	D4
1	0	1	D5
1	1	0	D6
1	1	1	D7



FIGURE 4.11 A block diagram of a multiplexer with three select control lines

A multiplexer can be designed with various numbers of input lines and corresponding control lines. In general, the binary values on n input control lines are used to determine which of 2^n other data lines are selected for output.

A circuit called a *demultiplexer* (*demux*) performs the opposite operation. That is, it takes a single input and routes it to one of 2^n outputs, depending on the values of the n control lines.

4.5 Circuits as Memory

Digital circuits play another important role: They can store information. These circuits form a sequential circuit, because the output of the circuit also serves as input to the circuit. That is, the existing state of the circuit is used in part to determine the next state.

Many types of memory circuits have been designed. We examine only one type in this book: the *S-R latch*. An S-R latch stores a single binary digit (1 or 0). An S-R latch circuit could be designed using a variety of gates. One such circuit, using NAND gates, is pictured in [FIGURE 4.12](#).

The design of this circuit guarantees that the two outputs X and Y are always complements of each other. That is, when X is 0, Y is 1, and vice versa. The value of X at any point in time is considered to be the current state of the circuit. Therefore, if X is 1, the circuit is storing a 1; if X is 0, the circuit is storing a 0.

Recall that a NAND gate produces an output of 1 unless both of its input values are 1. Each gate in this circuit has one external input (S or R) and one input coming from the output of the other gate. Suppose the current state of the circuit is storing a 1 (that is, X is 1), and suppose both S and R are 1. Then Y remains 0 and X remains 1. Now suppose that the circuit is currently storing a 0 (X is 0) and that R and S are again 1. Then Y remains 1 and X remains 0. No matter which value is currently being stored, if both input values S and R are 1, the circuit keeps its existing state.

This explanation demonstrates that the S-R latch maintains its value as long as S and R are 1. But how does a value get stored in the first place? We set the S-R latch to 1 by momentarily setting S to 0 while keeping R at 1. If S is 0, X becomes 1. As long as S is returned to 1 immediately, the S-R latch remains in a state of 1. We set the latch to 0 by momentarily setting R to 0 while keeping S at 1. If R is 0, Y becomes 0, and thus X becomes 0. As long as R is immediately reset to 1, the circuit state remains 0.

By carefully controlling the values of S and R, the circuit can be made to store either value. By scaling this idea to larger circuits, we can design memory devices with larger capacities.

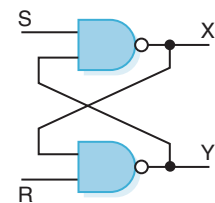


FIGURE 4.12 An S-R latch

Integrated circuit (chip) A piece of silicon on which multiple gates have been embedded

4.6 Integrated Circuits

An **integrated circuit** (also called a *chip*) is a piece of silicon on which multiple gates have been embedded. These silicon pieces are mounted on a plastic or ceramic package with pins along the edges that can be soldered onto circuit boards or inserted into appropriate sockets. Each pin connects to the input or output of a gate, or to power or ground.

Integrated circuits (IC) are classified by the number of gates contained in them. These classifications also reflect the historical development of IC technology:

Abbreviation	Name	Number of Gates
SSI	Small-scale integration	1 to 10
MSI	Medium-scale integration	10 to 100
LSI	Large-scale integration	100 to 100,000
VLSI	Very-large-scale integration	more than 100,000

An SSI chip has a few independent gates, such as the one shown in **FIGURE 4.13**. This chip has 14 pins: eight for inputs to gates, four for output of the gates, one for ground, and one for power. Similar chips can be made with different gates.

How can a chip have more than 100,000 gates on it? That would imply the need for 300,000 pins! The key is that the gates on a VLSI chip are not independent, as they are in small-scale integration. VLSI chips

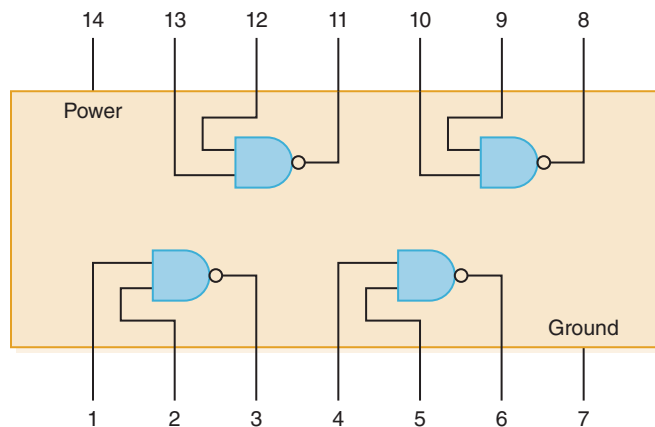


FIGURE 4.13 An SSI chip containing independent NAND gates

embed circuits with a high gate-to-pin ratio. That is, many gates are combined to create complex circuits that require only a few input and output values. Multiplexers are an example of this type of circuit.

4.7 CPU Chips

The most important integrated circuit in any computer is the central processing unit (CPU). The processing of a CPU is discussed in the next chapter, but it is important to recognize at this point that the CPU is, in one sense, merely an advanced circuit with input and output lines.

Each CPU chip contains a large number of pins through which essentially all communication in a computer system occurs. This communication connects the CPU to memory and I/O devices, which are themselves, at fundamental levels, advanced circuits.

The explanation of CPU processing and its interaction with other devices takes us to another level of computer processing, sometimes referred to as *component architecture*. Although it is still primarily focused on hardware, computer component architecture applies the principle of abstraction yet again, allowing us to temporarily ignore the details of the gates and circuits discussed in this chapter and bringing us ever closer to a complete understanding of computer processing.

© Artur Debat/Getty Images, © Alan Dyer/Stocktrek Images/Getty Images

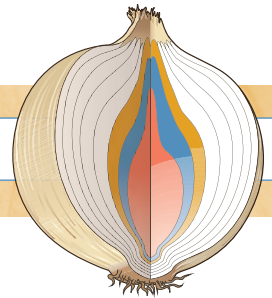
SUMMARY

In this chapter we discussed how a computer operates at its lowest level by controlling the flow of electricity. Because we are dealing with digital computers that use binary information, we concern ourselves with only two voltage ranges, which we interpret as binary 1 or 0. The flow of electricity is guided by electronic devices called *gates*, which perform basic logical operations such as NOT, AND, and OR. A gate is created by using one or more transistors, an invention that revolutionized computing.

Gates can be combined into circuits, in which the output of one gate serves as an input to another gate. By designing these circuits carefully, we can create devices that perform more complex tasks, such as adding, multiplexing, and storing data. Collections of gates, or *complete circuits*, are often embedded into a single integrated circuit, or *chip*, which leads to the concept of a central processing unit (CPU).

What is *computer ethics*?

Be careful—the term *computer ethics* is ambiguous. The use of the term in the tenth strand of computer science curricula refers to a code of ethics that computer professionals can apply within their own profession. *Computer ethics* also refers to determinations made by contemporary philosophers to cases that involve computers or computer networks.





ETHICAL ISSUES

Codes of Ethics⁵

There are two major organizations in computing: the Association of Computing Machinery and the Institute of Electrical and Electronics Engineers. The IEEE represents the hardware side and the ACM represents the software side. However, in many universities, this distinction is blurred. We are presenting both codes of ethics so you can compare and contrast them.

IEEE Code of Ethics

We, the members of the IEEE, in recognition of the importance of our technologies in affecting the quality of life throughout the world, and in accepting a personal obligation to our profession, its members, and the communities we serve, do hereby commit ourselves to the highest ethical and professional conduct and agree:

- to hold paramount the safety, health, and welfare of the public, to strive to comply with ethical design and sustainable development practices, and to disclose promptly factors that might endanger the public or the environment;
- to avoid real or perceived conflicts of interest whenever possible, and to disclose them to affected parties when they do exist;
- to be honest and realistic in stating claims or estimates based on available data;
- to reject bribery in all its forms;
- to improve the understanding by individuals and society of the capabilities and societal implications of conventional and emerging technologies, including intelligent systems;
- to maintain and improve our technical competence and to undertake technological tasks for others only if qualified by training or experience, or after full disclosure of pertinent limitations;
- to seek, accept, and offer honest criticism of technical work, to acknowledge and correct errors, and to credit properly the contributions of others;
- to treat fairly all persons and to not engage in acts of discrimination based on race, religion, gender, disability, age, national origin, sexual orientation, gender identity, or gender expression;
- to avoid injuring others, their property, reputation, or employment by false or malicious action;
- to assist colleagues and co-workers in their professional development and to support them in following this code of ethics.



ETHICAL ISSUES

Codes of Ethics, continued

ACM Code of Ethics (abridged)

At the time of this writing (2018), the ACM is undergoing a revision of their Code of Ethics. But here is a flyer summarizing their previous code:

THE CODE represents ACM's commitment to promoting the highest professional and ethical standards, and makes it incumbent on all **ACM Members** to:

- ◆ Contribute to society and human well-being.
- ◆ Avoid harm to others.
- ◆ Be honest and trustworthy.
- ◆ Be fair and take action not to discriminate.
- ◆ Honor property rights including copyrights and patent.
- ◆ Give proper credit for intellectual property.
- ◆ Respect the privacy of others.
- ◆ Honor confidentiality.

And as **computing professionals**, every **ACM Member** is also expected to:

- ◆ Strive to achieve the highest quality, effectiveness and dignity in both the process and products of professional work.
- ◆ Acquire and maintain professional competence.
- ◆ Know and respect existing laws pertaining to professional work.
- ◆ Accept and provide appropriate professional review.
- ◆ Give comprehensive and thorough evaluations of computer systems and their impacts, including analysis of possible risks.
- ◆ Honor contracts, agreements, and assigned responsibilities.
- ◆ Improve public understanding of computing and its consequences.
- ◆ Access computing and communication resources only when authorized to do so.

This flyer shows an abridged version of the ACM Code of Ethics.
The complete version can be viewed at: www.acm.org/constitution/code



Association for
Computing Machinery

Advancing Computing as a Science & Profession

KEY TERMS

Adder	Integrated circuit (also chip)
Boolean algebra	Logic diagram
Circuit	Multiplexer
Circuit equivalence	Semiconductor
Combinational circuit	Sequential circuit
Full adder	Transistor
Gate	Truth table
Half adder	

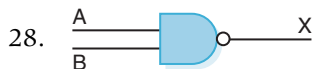
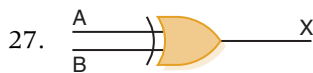
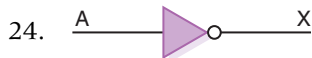
EXERCISES

For Exercises 1–17, mark the answers true or false as follows:

- A. True
 - B. False
1. Logic diagrams and truth tables are equally powerful in expressing the processing of gates and circuits.
 2. Boolean expressions are more powerful than logic diagrams in expressing the processing of gates and circuits.
 3. A NOT gate accepts two inputs.
 4. The output value of an AND gate is 1 when both inputs are 1.
 5. The AND and OR gates produce opposite results for the same input.
 6. The output value of an OR gate is 1 when both inputs are 1.
 7. The output of an OR gate is 0 when one input is 0 and one input is 1.
 8. The output value of an XOR gate is 0 unless both inputs are 1.
 9. The NOR gate produces the opposite results of the XOR gate.
 10. A gate can be designed to accept more than two inputs.
 11. A transistor is made of semiconductor material.
 12. Inverting the output of an AND gate is equivalent to inverting the individual signals first, then passing them through an OR gate.
 13. The sum of two binary digits (ignoring the carry) is expressed by an AND gate.
 14. A full adder takes the carry-in value into account.
 15. A multiplexer adds all of the bits on its input lines to produce its output.
 16. Integrated circuits are classified by the number of gates contained in them.
 17. A CPU is an integrated circuit.
- For Exercises 18–29, match the gate with the description of the operation or the diagram.
- A. AND
 - B. NAND

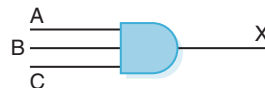
EXERCISES (CONTINUED)

- C. XOR
 - D. OR
 - E. NOR
 - F. NOT
18. Inverts its input.
 19. Produces a 1 only if all its inputs are 1 and a 0 otherwise.
 20. Produces a 0 only if all its inputs are 0 and a 1 otherwise.
 21. Produces a 0 only if its inputs are the same and a 1 otherwise.
 22. Produces a 0 if all its inputs are 1 and a 1 otherwise.
 23. Produces a 1 if all its inputs are 0 and a 0 otherwise.



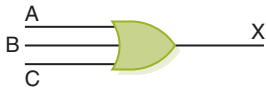
Exercises 30–73 are short-answer or design questions.

30. How is voltage level used to distinguish between binary digits?
31. Distinguish between a gate and a circuit.
32. What are the three notational methods for describing the behavior of gates and circuits?
33. Characterize the notations asked for in Exercise 32.
34. How many input signals can a gate receive, and how many output signals can a gate produce?
35. Name six types of gates.
36. Give the three representations of a NOT gate and say in words what NOT means.
37. Give the three representations of an AND gate and say in words what AND means.
38. Give the three representations of an OR gate and say in words what OR means.
39. Give the three representations of an XOR gate and say in words what XOR means.
40. Give the three representations of a NAND gate and say in words what NAND means.
41. Give the three representations of a NOR gate and say in words what NOR means.
42. Compare and contrast the AND gate and the NAND gate.
43. Give the Boolean expression for a three-input AND gate, and then show its behavior with a truth table.

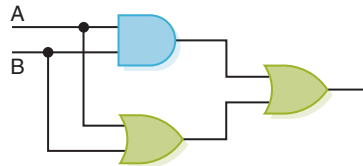


EXERCISES (CONTINUED)

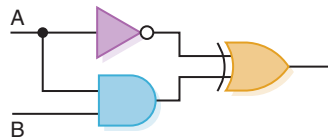
44. Give the Boolean expression for a three-input OR gate, and then show its behavior with a truth table.



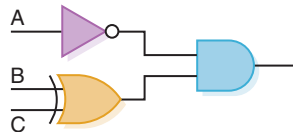
45. What is used in a gate to establish how the input values map to the output value?
46. How does a transistor behave?
47. Of what is a transistor made?
48. What happens when an electric signal is grounded?
49. What are the three terminals in a transistor, and how do they operate?
50. How many transistors does it take for each of these gates?
- NOT
 - AND
 - NOR
 - OR
 - XOR
51. Draw a transistor diagram for an AND gate. Explain the processing.
52. Draw a transistor diagram for an OR gate. Explain the processing.
53. How can gates be combined into circuits?
54. What are the two general categories of circuits, and how do they differ?
55. Draw a circuit diagram corresponding to the following Boolean expression: $(A + B)(B + C)$
56. Draw a circuit diagram corresponding to the following Boolean expression: $(AB + C)D$
57. Draw a circuit diagram corresponding to the following Boolean expression: $A'B + (B + C)'$
58. Draw a circuit diagram corresponding to the following Boolean expression: $(AB)' + (CD)'$
59. Show the behavior of the following circuit with a truth table:



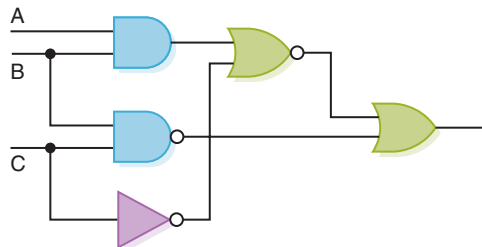
60. Show the behavior of the following circuit with a truth table:



61. Show the behavior of the following circuit with a truth table:



62. Show the behavior of the following circuit with a truth table:



EXERCISES (CONTINUED)

63. What is *circuit equivalence*?
64. Name six properties of Boolean algebra and explain what each means.
65. Differentiate between a half adder and a full adder.
66. What is the Boolean expression for a full adder?
67. What is a multiplexer?
68.
 - a. Circuits used for memory are what type of circuits?
 - b. How many digits does an S-R latch store?
 - c. The design for an S-R latch shown in Figure 4.12 guarantees what about the outputs X and Y?
69. What is an integrated circuit or chip?
70. Define the abbreviations *SSI*, *MSI*, *LSI*, and *VLSI*.
71. In the chip shown in Figure 4.13, what are the pins used for?
72. Draw a circuit using two full adders that adds two 2-bit binary values. Show its corresponding truth table.
73. How can the XOR operation be expressed using other operators?

THOUGHT QUESTIONS

1. Throughout this chapter we have used Boolean expressions, truth tables, and logic diagrams to describe the same behavior. Are the relationships among these notational methods clear to you? Which do you find the most intuitive? Which do you find the least intuitive?
2. Many situations can be described by the ideas in this chapter—for example, the operation of a single light switch or a light that has two switches. Can you think of other everyday occurrences that can be described by the notational methods presented in this chapter?
3. How do the two sets of codes of ethics presented at the end of this chapter differ? How are they similar?
4. Have you ever sent email to someone, only to regret it immediately? Do you find that you would say something in email that you would never say in person? Consider the following premise: “Email has lowered the civility of personal discourse.” Do you agree or disagree?
5. If a person sends email from a school computer or a business computer, should that message be considered private? Does the institution or person that owns the computer from which email is sent have a right to inspect the message?

Laying the Groundwork

- 1 The Big Picture

The Information Layer

- 2 Binary Values and Number Systems
- 3 Data Representation

The Hardware Layer

- 4 Gates and Circuits
- 5 Computing Components

The Programming Layer

- 6 Low-Level Programming Languages and Pseudocode
- 7 Problem Solving and Algorithms
- 8 Abstract Data Types and Subprograms
- 9 Object-Oriented Design and High-Level Programming Languages

The Operating Systems Layer

- 10 Operating Systems
- 11 File Systems and Directories

The Applications Layer

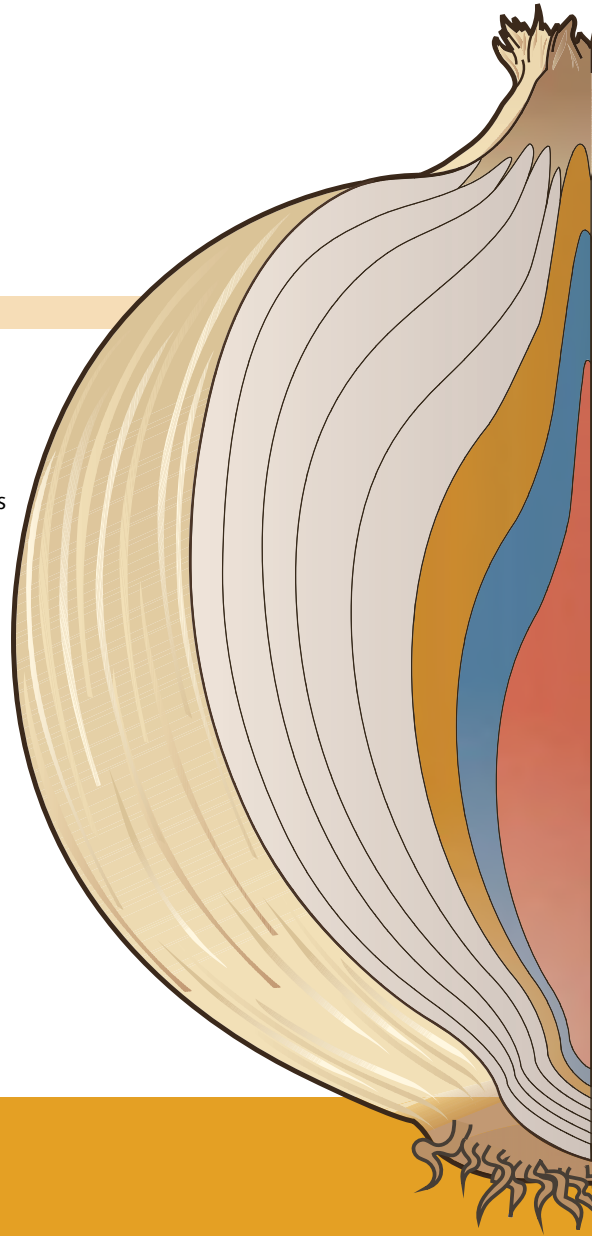
- 12 Information Systems
- 13 Artificial Intelligence
- 14 Simulation, Graphics, Gaming, and Other Applications

The Communications Layer

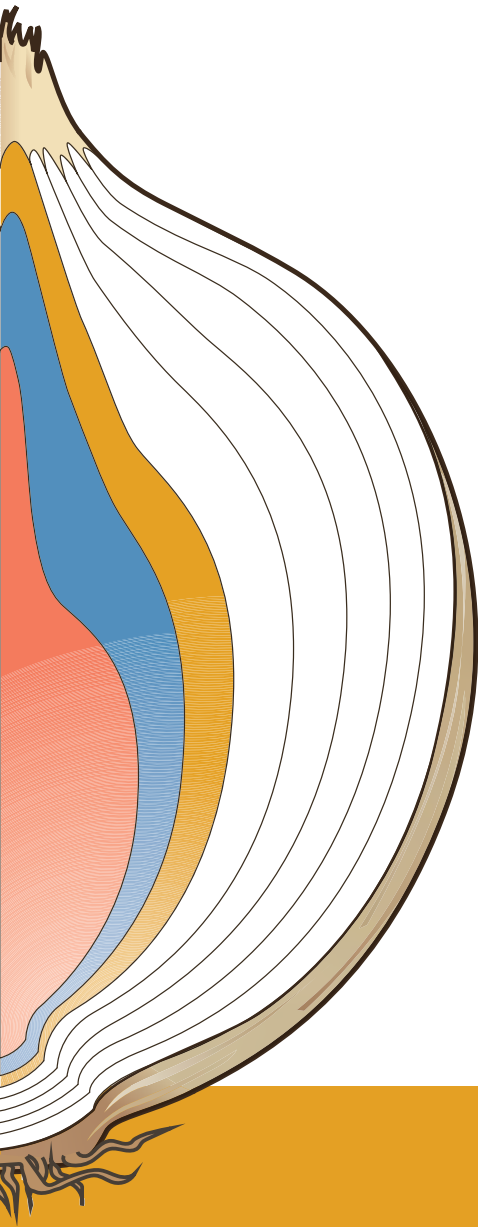
- 15 Networks
- 16 The World Wide Web
- 17 Computer Security

In Conclusion

- 18 Limitations of Computing



THE HARDWARE LAYER



5

COMPUTING COMPONENTS

Chapter 2 described the binary number system in which all information is represented on a computer. Chapter 4 described how we control electricity at a fundamental level to manage binary values. Now we can describe the primary components of a computer that capitalize on these technologies. These primary components are like Lego pieces; they can be combined to build a variety of different computers.

Although these components, such as main memory and the central processing unit (CPU), are often thought of as the most fundamental parts of a computer, we know that they are abstractions of even more fundamental concepts.

GOALS

After studying this chapter, you should be able to:

- read an ad for a computer and understand the jargon.
- list the components and their function in a von Neumann machine.
- describe the fetch–decode–execute cycle of the von Neumann machine.
- describe how computer memory is organized and accessed.
- name and describe the various auxiliary storage devices.
- define three alternative parallel computer configurations.
- explain the concept of embedded systems and give examples from your own home.

5.1 Individual Computer Components

Computing, more than most fields, has its own special jargon and acronyms. We begin this chapter by translating the specification for a laptop computer. We then examine the components of a computer as a logical whole before looking at each component in some detail.

Consider the following specification for a laptop computer that might appear in a typical advertisement.

Dell Inspiron 5000

- 2.5 GHz Intel Core i5 (1066 MHz FSB / 6 MB cache)
- 15.6 inch Full HD LED touchscreen (1920 x 1080)
- 8 GB SDRAM DDR3
- Intel HD Graphics 520
- 1 TB HDD 5400 RPM
- DVD +/- RW drive
- 802.11A, 802.11bgn, and Bluetooth wireless
- Intel RealSense 3D camera
- Lithium Ion Battery with 7-hour average life
- Ports: 1 USB 3.0, 2 USB 2.0, 1 HDMI, LAN 10/100, audio input/output
- 15 x 10.2 x 0.9 inches, 5.36 pounds
- Windows 10 Operating System

There are two important and interesting things about this list: The average person probably doesn't know what it all means, and by the time you are reading it, the machine it describes may be obsolete. In this chapter, we try to give you a better understanding of these elements and the acronyms used to describe them.

Before we go on to describe computer components in the abstract, let's go through this specification briefly. After this exercise, we go through all of the material again in more depth, so don't be concerned if the terms seem confusing. You'll see all of them defined again later.

The first line describes the central processor inside the laptop. Core™ i5 is a type of processor, which runs at a speed of 2.5 GHz. The *G* in *GHz* is the abbreviation for *giga-*, a metric prefix indicating one billion. *Hz* stands for *hertz*, a unit of frequency that measures cycles per second, named after Heinrich R. Hertz. In a computer, a centrally generated series of electrical pulses, called the *clock*, is used to ensure that all of its actions are coordinated. You can think of the clock like an orchestra conductor's waving baton, which keeps all of the musicians playing together at a particular tempo. The clock in this processor pulses 2.5 billion times per second.

Following the clock speed number, we read *1066 MHz FSB*. Knowing that *M* in the metric system stands for *million*, we can guess that something called *FSB* is pulsing 1066 million (or just over a billion) times per second. What is the FSB? A processor needs to access memory and input/output devices and does so through a set of wires called a *bus*. A computer has many different buses, but the one that makes the primary connection

between the processor and the outside world is called the *front-side bus* (FSB). Thus, these processors can communicate with the outside world 1066 million times per second. But if each of the processors is performing 2.5 billion operations per second, how can the FSB keep up at only one billion accesses per second?

The answer is related to the *6 MB cache*. *MB* stands for megabytes. A byte is a unit of memory, and a *megabyte* is 2^{20} (a little more than a million) bytes. So *6 MB* refers to six megabytes of cache memory. Cache is small, fast memory that is usually built into the processor chip. Thus, the two processors have direct access to 6 MB of memory without using the FSB. Many of the processors' attempts to access memory will find what they need within the cache. They only activate the FSB when they need something that is not in cache. Thus, the FSB can be slower than the processors and still not get in their way.

In general, a faster clock, faster FSB, and more cache would seem to make for a more powerful computer. But as in all areas of engineering, there are tradeoffs. If the processor runs faster, it consumes more power, which can cause the circuitry to overheat and shut down. A faster FSB requires faster devices in the outside world, which means their circuitry is more expensive. As cache gets bigger, access to its data becomes slower, which slows down the processors.

The next part of the ad describes the screen. The number *15.6* refers to the diagonal measurement of the display area. *High definition (HD)* means it is compatible with the high-definition television standard. *LED* stands for *light-emitting diode*, just like those found in some flashlights. The advantages are that LEDs last longer without growing dim and do not contain the toxic metal mercury. Lastly, the numbers 1920×1080 refer to the screen's resolution in picture elements (pixels). This screen is 1920 pixels wide and 1080 pixels high.

This laptop has a separate graphics processor unit (GPU), the Intel HD Graphics 520. A GPU is a separate computer chip that can be even more powerful than the main processors. Games and other graphics software send commands to the GPU that cause it to manipulate the image on the screen very quickly. It thus relieves the main processors of this task. The GPU keeps the data for the screen image in its own memory. The more it has, the better it is able to work with complex images, support external displays, and so on.

Next the ad lists the computer's random access memory (RAM), also called *main memory*. More precisely, *SDRAM* stands for *synchronous, dynamic RAM*. *Random access* means that each byte of memory can be accessed directly, rather than having to begin at the beginning and access each byte in turn until you get to the one you want. *8 GB* means that there are

8×2^{30} bytes of storage (2^{30} is just over one billion). *Shared* means that both processors have access to this memory. *DDR3* is the type of memory. Through clever use of circuitry, memory designers increased the rate at which a memory could operate, compared with earlier designs. Their achievement is acknowledged in this acronym.

This laptop contains a hard disk drive (HDD), which is the common name for the computer's secondary storage device. It is listed as having 1 TB (terabyte, or 1 trillion bytes) of storage. The ad also mentions 5400 RPM (revolutions per minute), which is how fast the disk spins. Disks in laptops spin relatively slowly to conserve battery power. Disks are also available that spin at 7200 RPM and 15,000 RPM, enabling them to transfer data at a higher rate. Hard drives are gradually being replaced by all-electronic secondary storage, called *solid-state disks* (SSDs). The technology of SSD is similar to RAM, except that data isn't lost when the power is turned off. Because it has no moving parts, it is faster and consumes less power than a hard drive. At this early stage in the transition, SSD is more expensive and has less storage capacity, but those factors can be expected to change as the technology advances.

A DVD drive comes with the machine. Following the *DVD* acronym are the symbols *+/-RW*. The *R* indicates that the drive can record on special DVDs that are writeable. There are actually two standards for how these disks are made, called *-R* and *+R*, and the *+/-* indicates that the drive is compatible with both standards. A *DVD +/-R* can have data written just once. After that, it can be read any number of times, but no more writing is allowed. Another type of DVD, called *RW* (for *rewritable*) can be written more than once. This laptop also supports *RW* disks. While DVD drives are still the most popular, some laptops are starting to shift to the newer Blu-Ray format, which has higher capacity and is being used to distribute high-definition movies.

The next line of the ad describes its wireless networking support. 802.11 is the number of a standard that has been defined by the Institute of Electrical and Electronics Engineers (IEEE), an engineering professional society. There are four versions of the standard: a, b, g, and n. The original was 802.11a. 802.11b was a variation of the original. The 802.11g version supports communication over longer distances, but at a slightly slower speed. With 802.11n, both greater speed and distance are achieved. This laptop is compatible with all four standards. Bluetooth is another form of wireless network, but it operates at much shorter ranges with a relatively weak signal. Typical uses for Bluetooth are to connect with a wireless keyboard, mouse, or earphones, or for transferring data

to and from a cell phone. There have been multiple versions of the Bluetooth standard, each adding various features.

The next line in the ad describes a built-in digital camera that faces the user from just above the screen. This camera can be used for video conferencing over the Internet or recording still images and videos. This camera is described as a *3D camera*, which means in addition to standard 2D lens technology, it also has an infrared camera that allows it to see the distance between objects, allowing for better facial and gesture recognition.

Of course, laptops run on batteries. Even so, they still consume quite a bit of power. When a laptop is idle, with the screen turned off, it will use just a few watts. But in playing a game that makes heavy use of both processors and the GPU, it can draw 50 watts. That's far more energy than normal rechargeable batteries can supply, so special technology, based on the metal lithium, provides high electrical storage capacity. This laptop's battery provides an average of 7 hours of use between charges, depending on how it's used. A stronger battery means a longer time without recharging, but it also adds size and weight to the laptop.

Next, the ad has a list of external connections (often called *ports*). USB, or universal serial bus, uses a cable to transfer data. As the term suggests, it can connect to just about anything, including an external hard drive, digital camera, printer, scanner, music player, and so on. This laptop has two second-generation USB ports and one third-generation USB port, which relate to the speed of data transfer. This laptop also has one HDMI port. *HDMI* stands for *high-definition multimedia interface*, which can send digital video and audio to, for example, a home theater system. An Ethernet connection (LAN 10/100) is available for wired network access. Lastly, we see that we can connect analog audio inputs and outputs, such as headphones or an external microphone.

Physical size and weight are important parameters for a laptop that will be carried regularly. This is a mid-size, mid-weight model. At 5.36 pounds, it weighs over twice as much as this book. A lightweight laptop has roughly the same weight as this book, and heavier models, sometimes called *desktop replacements*, can weigh in at around 8 pounds. Generally, to reduce weight, the size shrinks and we give up features and battery life. However, it is also possible to reduce weight by replacing plastic in the case with aluminum, but for greater cost.

Lastly, the ad lists software that is preinstalled on the laptop. This laptop is running the Windows 10 operating system developed by Microsoft. A computer might also include preinstalled software for word processing, spreadsheets, or malware detection.

Putting sizes in perspective

Admiral Grace Murray Hopper demonstrated the relative sizes of computer jargon by displaying a coil of wire nearly 1000 feet long, a short piece of wire about as long as your forearm, and a bag containing grains of pepper. She would say that the wire coil was the distance traveled in the space of a microsecond. The short piece was the distance traveled along the wire in the space of a nanosecond. The grains of pepper represented the distance traveled by an electron in a picosecond.

Within this ad, multiple size measures have been used. Let's summarize the prefixes that are used frequently in computing.

Power of 10	Power of 2	Value of Power of 2	Prefix	Abbreviation	Derivation
10^{-12}			pico-	p	Italian for <i>little</i>
10^{-9}			nano-	n	Greek for <i>dwarf</i>
10^{-6}			micro-	μ	Greek for <i>small</i>
10^{-3}			milli-	m	Latin for <i>thousandth</i>
10^3	2^{10}	1024	kilo-	K	Greek for <i>thousand</i>
10^6	2^{20}	1,048,576	mega-	M	Greek for <i>large</i>
10^9	2^{30}	1,073,741,824	giga-	G	Greek for <i>giant</i>
10^{12}	2^{40}	not enough room	tera-	T	Greek for <i>monster</i>
10^{15}	2^{50}	not enough room	peta-	P	Greek prefix for <i>five</i>

Did you notice that we used powers of 10 when referring to time and powers of 2 when referring to storage? Time is expressed in multiples of seconds in decimal notation. Storage capacity is expressed in multiples of bytes in binary notation. If you keep this distinction in mind, it is clear that *K* is 1000 when referring to speed and 1024 when referring to storage.

We now move from the specific to the general. In the next several sections, we look at each of the pieces of hardware that make up a computer from the logical level, rather than from a specific computer configuration.

5.2 The Stored-Program Concept

A major defining point in the history of computing was the realization in 1944–1945 that data and instructions to manipulate the data were logically the same and could be stored in the same place. The computer design built upon this principle, which became known as the *von Neumann architecture*, is still the basis for computers today. Although the name honors John von Neumann, a brilliant mathematician who worked on the construction of the atomic bomb, the idea probably originated with J. Presper Eckert and John Mauchly, two other early pioneers who worked on the ENIAC at the Moore School at the University of Pennsylvania during the same time period.



Far-reaching discovery

Within six weeks of beginning to program, Maurice Wilkes made one of the most far-reaching discoveries of the computer age: To get programs right is more difficult than it looks.¹

© Artur Debat/Getty Images; © Alan Dyer/Stocktrek Images/Getty Images

John Vincent Atanasoff

John Vincent Atanasoff was born in Hamilton, New York, on October 4, 1903, one of nine children. When he was about ten, his father bought a new slide rule. After reading the instructions, John Vincent became more interested in the mathematics involved than in the slide rule itself. John Vincent graduated from the University of Florida in 1925 with a degree in electrical engineering. A year later, he received a master's degree in mathematics from Iowa State College. In 1930, after receiving his PhD in theoretical physics, he returned to Iowa State College as an assistant professor in mathematics and physics.

Dr. Atanasoff became interested in finding a machine that could do the complex mathematical work he and his graduate students were doing. He examined computational devices in existence at that time, including the Monroe calculator and the IBM tabulator. Upon concluding that these machines were too slow and inaccurate, he became obsessed with finding a solution. He said that at night in a tavern after a drink of bourbon he began generating ideas of how to build this computing device. It would be electronically operated and would compute by direct logical action rather than enumeration, as in analog devices. It would use binary numbers rather than decimal numbers, condensers for memory, and a regenerative process to avoid lapses due to leakage of power.

In 1939, with a \$650 grant from the school and a new graduate assistant named Clifford Berry, Dr. Atanasoff began work on the first prototype of the Atanasoff-Berry Computer (ABC) in the basement of the physics building. The first working prototype was demonstrated that year.

In 1941, John Mauchly, a physicist at Ursinus College whom Dr. Atanasoff had met at

a conference, came to Iowa State to visit the Atanasoffs and see a demonstration of the ABC machine. After extensive discussions, Mauchly left with papers describing its design. Mauchly and J. Presper Eckert continued their work on a computation device at the Moore School of Electrical Engineering at the University of Pennsylvania. Their machine, the ENIAC, completed in 1945, became known as the first computer.

Dr. Atanasoff moved to Washington in 1942, leaving the patent application for the ABC computer in the hands of the Iowa State attorneys. The patent application was never filed and the ABC was eventually dismantled without either Atanasoff or Berry being notified.

In 1952, Dr. Atanasoff established the Ordnance Engineering Corporation, a research and engineering firm, which was later sold to Aerojet General Corporation. He continued to work for Aerojet until he retired in 1961.

Meanwhile, in 1947 Mauchly and Eckert applied for the patent on their ENIAC computer. Sperry Rand brought suit. The subsequent trial lasted 135 working days and filled more than 20,000 pages of transcript from the testimony of 77 witnesses, including Dr. Atanasoff. Judge Larson found that Mauchly and Eckert "did not themselves first invent the automatic electronic digital computer, but instead derived that subject matter from one Dr. John Vincent Atanasoff."

In 1990, President George H. W. Bush acknowledged Dr. Atanasoff's pioneering work by awarding him the National Medal of Technology. Dr. Atanasoff died on June 15, 1995.



Courtesy of ISU Photo Service

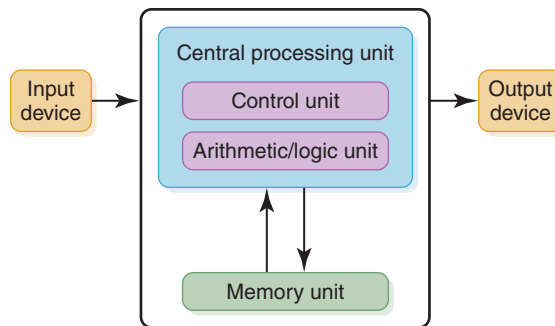


FIGURE 5.1 The von Neumann architecture

von Neumann Architecture

Another major characteristic of the von Neumann architecture is that the units that process information are separate from the units that store information. This characteristic leads to the following five components of the von Neumann architecture, shown in [FIGURE 5.1](#):

- The memory unit, which holds both data and instructions
- The arithmetic/logic unit, which is capable of performing arithmetic and logic operations on data
- The input unit, which moves data from the outside world into the computer
- The output unit, which moves results from inside the computer to the outside world
- The control unit, which serves as the stage manager to ensure that all the other components act in concert

Memory

Recall from the discussion of number systems that each storage unit, called a *bit*, is capable of holding a 1 or a 0; these bits are grouped together into bytes (8 bits), and these bytes are in turn grouped together into words. Memory is a collection of cells, each with a unique physical address. We use the generic word *cell* here rather than *byte* or *word*, because the number of bits in each addressable location, called the memory's **addressability**, varies from one machine to another. Today, most computers are byte addressable.

The ad in the previous section describes a memory of 4×2^{30} bytes. This means that each of the 4 GB is uniquely addressable. Therefore, the addressability of the machine is 8 bits. The cells in memory are numbered consecutively beginning with 0. For example, if the addressability is 8, and there are 256 cells of memory, the cells would be addressed as follows:

Addressability The number of bits stored in each addressable location in memory

Address	Contents
00000000	11100011
00000001	10101001
.	.
.	.
.	.
11111100	00000000
11111101	11111111
11111110	10101010
11111111	00110011

What are the contents of address **11111110**? The bit pattern stored at that location is **10101010**. What does it mean? We can't answer that question in the abstract. Does location **11111110** contain an instruction? An integer with a sign? A two's complement value? Part of an image? Without knowing what the contents represent, we cannot determine what it means: It is just a bit pattern. We must apply an interpretation on any bit pattern to determine the information it represents.

When referring to the bits in a byte or word, the bits are numbered from right to left beginning with zero. The bits in address **11111110** are numbered as follows:

7	6	5	4	3	2	1	0	← Bit position
1	0	1	0	1	0	1	0	← Contents

Arithmetic/Logic Unit

The **arithmetic/logic unit (ALU)** is capable of performing basic arithmetic operations such as adding, subtracting, multiplying, and dividing two numbers. This unit is also capable of performing logical operations such as AND, OR, and NOT. The ALU operates on words, a natural unit of data associated with a particular computer design. Historically, the word length of a computer has been the number of bits processed at once by the ALU. However, the current Intel line of processors has blurred this definition by defining the word length to be 16 bits. The processor can work on words (16 bits), double words (32 bits), and quadwords (64 bits). In the rest of this discussion, we continue to use *word* in its historical sense.

Most modern ALUs have a small number of special storage units called **registers**. These registers contain one word and are used to store information that is needed again immediately. For example, in the calculation of $\text{One} * (\text{Two} + \text{Three})$

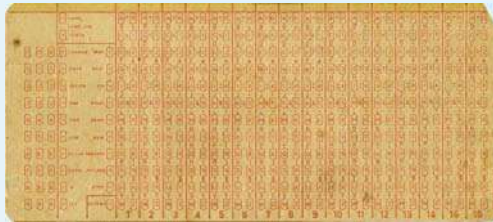
Arithmetic/logic unit (ALU) The computer component that performs arithmetic operations (addition, subtraction, multiplication, and division) and logical operations (comparison of two values)

Register A small storage area in the CPU used to store intermediate values or special data

© Artur Debat/Getty Images; © Alan Dyer/Stocktrek Images/Getty Images

Who Was Herman Hollerith?

In 1889 the United States Census Bureau realized that unless it found a better way to count the 1890 census, the results might not be tabulated before the next required census in 1900. Herman Hollerith had designed a method of counting



© iStockphoto/Thinkstock

based on cards with holes punched in them. This method was used for tabulating the census, and the cards became known as *Hollerith cards*. Hollerith's electrical tabu-

lating system led to the founding of the company known today as *IBM*.

Two is first added to Three and the result is then multiplied by One. Rather than storing the result of adding Two and Three in memory and then retrieving it to multiply it by One, the result is left in a register and the contents of the register are multiplied by One. Access to registers is much faster than access to memory locations.

Input/Output Units

All of the computing power in the world wouldn't be useful if we couldn't input values into the calculations from outside or report to the outside the results of those calculations. Input and output units are the channels through which the computer communicates with the outside world.

An **input unit** is a device through which data and programs from the outside world are entered into the computer. The first input units interpreted holes punched on paper tape or cards. Modern-day input devices include the keyboard, the mouse, and the scanning devices used at supermarkets.

An **output unit** is a device through which results stored in the computer memory are made available to the outside world. The most common output devices are printers and displays.

Control Unit

The **control unit** is the organizing force in the computer, for it is in charge of the fetch–execute cycle, discussed in the next section. There are two

Input unit A device that accepts data to be stored in memory

Output unit A device that prints or otherwise displays data stored in memory or makes a permanent copy of information stored in memory or another device

Control unit The computer component that controls the actions of the other components so as to execute instructions in sequence

special registers in the control unit. The **instruction register (IR)** contains the instruction that is being executed, and the **program counter (PC)** contains the address of the next instruction to be executed. Because the ALU and the control unit work so closely together, they are often thought of as one unit called the *central processing unit*, or **CPU**.

FIGURE 5.2 shows a simplified view of the flow of information through the parts of a von Neumann machine. The parts are connected to one another by a collection of wires called a *bus*, through which data travels in the computer. Each bus carries three kinds of information: address, data, and control. An address is used to select the memory location or device to which data will go or from which it will be taken. Data then flows over the bus between the CPU, memory, and I/O devices. The control information is used to manage the flow of addresses and data. For example, a control signal will typically be used to determine the direction in which the data is flowing, either to or from the CPU. The **bus width** is the number of bits that it can transfer simultaneously. The wider the bus, the more address or data bits it can move at once.

Because memory accesses are very time consuming relative to the speed of the processor, many architectures provide **cache memory**. Cache memory is a small amount of fast-access memory into which copies of frequently used data are stored. Before a main memory access is made, the CPU checks whether the data is stored in the cache memory. **Pipelining** is another technique used to speed up the fetch–execute cycle. This technique splits an instruction into smaller steps that can be overlapped.

In a personal computer, the components in a von Neumann machine reside physically in a printed circuit board called the **motherboard**. The motherboard also has connections for attaching other devices to the bus, such as a mouse, a keyboard, or additional storage devices. (See the section on secondary storage devices later in this chapter.)

So just what does it mean to say that a machine is an n -bit processor? The variable n usually refers to the number of bits in the CPU general registers: Two n -bit numbers can be added with a single instruction. It also can refer to the width of the address bus, which is the size of

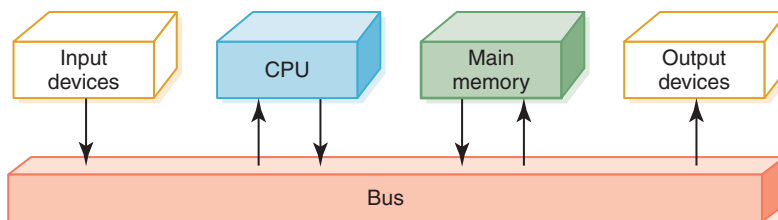


FIGURE 5.2 Data flow through a von Neumann machine

Instruction register (IR)

The register that contains the instruction currently being executed

Program counter (PC)

The register that contains the address of the next instruction to be executed

CPU The central processing unit, a combination of the arithmetic/logic unit and the control unit; the “brain” of a computer, which interprets and executes instructions

Bus width The number of bits that can be transferred in parallel over the bus

Cache memory A type of small, high-speed memory used to hold frequently used data

Pipelining A technique that breaks an instruction into smaller steps that can be overlapped

Motherboard The main circuit board of a personal computer

the addressable memory—but not always. In addition, n can refer to the width of the data bus—but not always.

The Fetch–Execute Cycle

Before looking at *how* a computer does what it does, let's look at *what* it can do. The definition of a computer outlines its capabilities: A computer is a device that can store, retrieve, and process data. Therefore, all of the instructions that we give to the computer relate to storing, retrieving, and processing data. In Chapters 6 and 9, we look at various languages that we can use to give instructions to the computer. For our examples here, we use simple English-like instructions.

Recall the underlying principle of the von Neumann machine: Data and instructions are stored in memory and treated alike. This means that instructions and data are both addressable. Instructions are stored in contiguous memory locations; data to be manipulated are stored together in a different part of memory. To start the fetch–execute cycle, the address of the first instruction is loaded into the program counter.

The processing cycle includes four steps:

- Fetch the next instruction.
- Decode the instruction.
- Get data if needed.
- Execute the instruction.

Let's look at each of these steps in more detail. The process starts with the address in memory of the first instruction being stored in the program counter.

Fetch the Next Instruction

The program counter (PC) contains the address of the next instruction to be executed, so the control unit goes to the address in memory specified in the PC, makes a copy of the contents, and places the copy in the instruction register. At this point the IR contains the instruction to be executed. Before going on to the next step in the cycle, the PC must be updated to hold the address of the next instruction to be executed when the current instruction has been completed. Because the instructions are stored contiguously in memory, adding the number of bytes in the current instruction to the program counter should put the address of the next instruction into the PC. Thus the control unit increments the PC. It is possible that the PC may be changed later by the instruction being executed.

In the case of an instruction that must get additional data from memory, the ALU sends an address to the memory bus, and the memory



Christmas 2013 is swiped

About 70 million debit and/or credit card accounts were jeopardized because of a data breach at Target (the second-largest discount retailer in the United States) between November 27 and December 15, 2013. Online transactions were not affected, but some in-store transactions for which credit cards were swiped were compromised. Card numbers were stolen, along with their expiration date, name, and credit verification value. Encrypted PIN data for debit cards was also involved in the data theft.²

responds by returning the value at that location. In some computers, data retrieved from memory may immediately participate in an arithmetic or logical operation. Other computers simply save the data returned by the memory into a register for processing by a subsequent instruction. At the end of execution, any result from the instruction may be saved either in registers or in memory.

Decode the Instruction

To execute the instruction in the instruction register, the control unit has to determine what instruction it is. It might be an instruction to access data from an input device, to send data to an output device, or to perform some operation on a data value. At this phase, the instruction is decoded into control signals. That is, the logic of the circuitry in the CPU determines which operation is to be executed. This step shows why a computer can execute only instructions that are expressed in its own machine language. The instructions themselves are literally built into the circuits.

Get Data If Needed

The instruction to be executed may potentially require additional memory accesses to complete its task. For example, if the instruction says to add the contents of a memory location to a register, the control unit must get the contents of the memory location.

Execute the Instruction

Once an instruction has been decoded and any operands (data) fetched, the control unit is ready to execute the instruction. Execution involves sending signals to the arithmetic/logic unit to carry out the processing. In the case of adding a number to a register, the operand is sent to the ALU and added to the contents of the register.

When the execution is complete, the cycle begins again. If the last instruction was to add a value to the contents of a register, the next instruction probably says to store the results into a place in memory. However, the next instruction might be a control instruction—that is, an instruction that asks a question about the result of the last instruction and perhaps changes the contents of the program counter.

FIGURE 5.3 summarizes the fetch–execute cycle.

Hardware has changed dramatically in the last half-century, yet the von Neumann machine remains the basis of most computers today. As Alan Perlis, a well-known computer scientist, said in 1981, “Some-

The Internet of Things

?

Devices that transmit data via the Internet have become so prevalent that the collection is now referred to as the *Internet of Things* (IoT). It includes mobile devices, vehicles, home appliances, cameras, heart-monitoring implants, transponders on animals—anything with embedded electronics or software that allows it to share data on a network.

Between 2016 and 2017, the number of IoT devices in use grew 31% to 8.4 billion. Experts estimate that growth will continue to 30 billion by 2020.

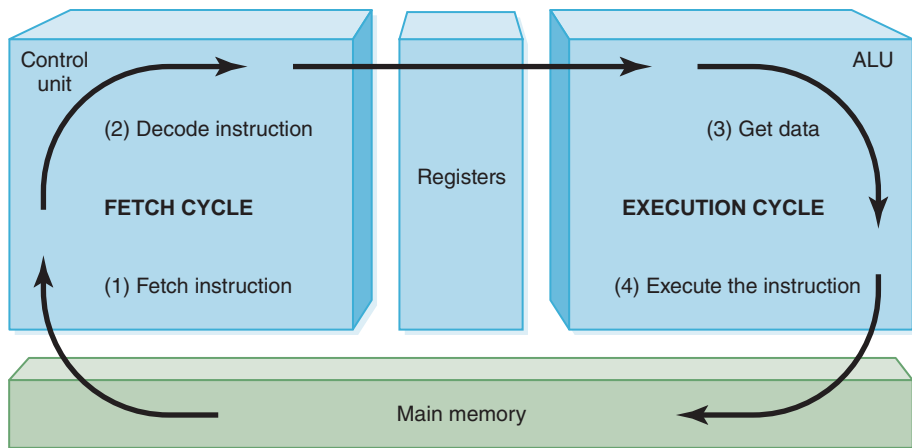


FIGURE 5.3 The fetch–execute cycle

times I think the only universal in the computing field is the fetch–execute cycle.”³ This statement is still true today, more than three decades later.

RAM and ROM

As mentioned, *RAM* stands for *random-access memory*. RAM is memory in which each cell (usually a byte) can be directly accessed. Inherent in the idea of being able to access each location is the ability to *change* the contents of each location. That is, storing something else into that place can change the bit pattern in each cell.

In addition to RAM, most computers contain a second kind of memory, called *ROM*. *ROM* stands for *read-only memory*. The contents in locations in ROM cannot be changed. Their contents are permanent and cannot be altered by a stored operation. Placing the bit pattern in ROM is called *burning*. The bit pattern is burned either at the time the ROM is manufactured or at the time the computer parts are assembled.

RAM and ROM are differentiated by a very basic property: RAM is volatile; ROM is not. This means that RAM does not retain its bit configuration when the power is turned off, but ROM does. The bit patterns within ROM are permanent. Because ROM is stable and cannot be changed, it is used to store the instructions that the computer needs to start itself. Frequently used software is also stored in ROM so that the system does not have to read the software each time the machine is turned on. Main memory usually contains some ROM along with the general-purpose RAM.

Secondary Storage Devices

As mentioned earlier, an input device is the means by which data and programs are entered into the computer and stored into memory. An output device is the means by which results are sent back to the user. Because most of main memory is volatile and limited, it is essential that there be other types of storage devices where programs and data can be stored when they are no longer being processed or when the machine is not turned on. These other types of storage devices (other than main memory) are called *secondary* or *auxiliary* storage devices. Because data must be read from them and written to them, each secondary storage device is also an input and an output device.

Secondary storage devices can be installed within the computer box at the factory or added later as needed. Because these devices can store large quantities of data, they are also known as *mass storage devices*. For example, the hard disk drive that comes with the laptop specified in the ad can store 1000×2^{30} bytes as opposed to 4×2^{30} bytes in main memory.

The next sections describe some secondary storage devices.

Magnetic Tape

Card readers and card punches were among the first input/output devices. Paper tape readers and punches were the next input/output devices. Although paper tapes, like cards, are permanent, they cannot hold much data. The first truly mass auxiliary storage device was the *magnetic tape drive*. A magnetic tape drive is like a tape recorder and is most often used to back up (make a copy of) the data on a disk in case the disk is later damaged. Tapes come in several varieties, from small streaming-tape cartridges to large reel-to-reel models.

Tape drives have one serious drawback: To access data in the middle of the tape, all the data before the piece you want must be accessed and discarded. Although modern streaming-tape systems have the capability of skipping over segments of tape, the tape must physically move through the read/write heads. Any physical movement of this type is time consuming. See [FIGURE 5.4](#).

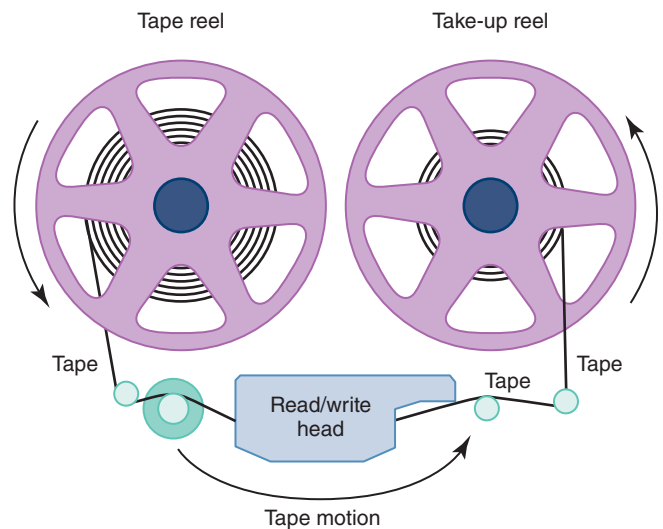


FIGURE 5.4 A magnetic tape

Magnetic Disks

A *disk drive* is a cross between a compact disc player and a tape recorder. A read/write head (similar to the record/playback head in a tape recorder) travels across a spinning magnetic disk, retrieving or recording data. As on a compact disc, the heads travel directly to the information desired; as on a tape, the information is stored magnetically.

Disks come in several varieties, but all of them consist of a thin disk made out of magnetic material. The surface of each disk is logically organized into **tracks** and **sectors**. Tracks are concentric circles around the surface of the disk. Each track is divided into sectors. Each sector holds a **block** of information as a continuous sequence of bits. See [FIGURE 5.5\(a\)](#). The figure depicts the original layout of data on a disk, in which each track has the same number of sectors, and each sector holds the same number of bits. The blocks of data nearer the center were more densely packed. On modern disks, there are fewer sectors near the middle and more toward the outside. The actual number of tracks per surface and the

Track A concentric circle on the surface of a disk

Sector A section of a track

Block The information stored in a sector

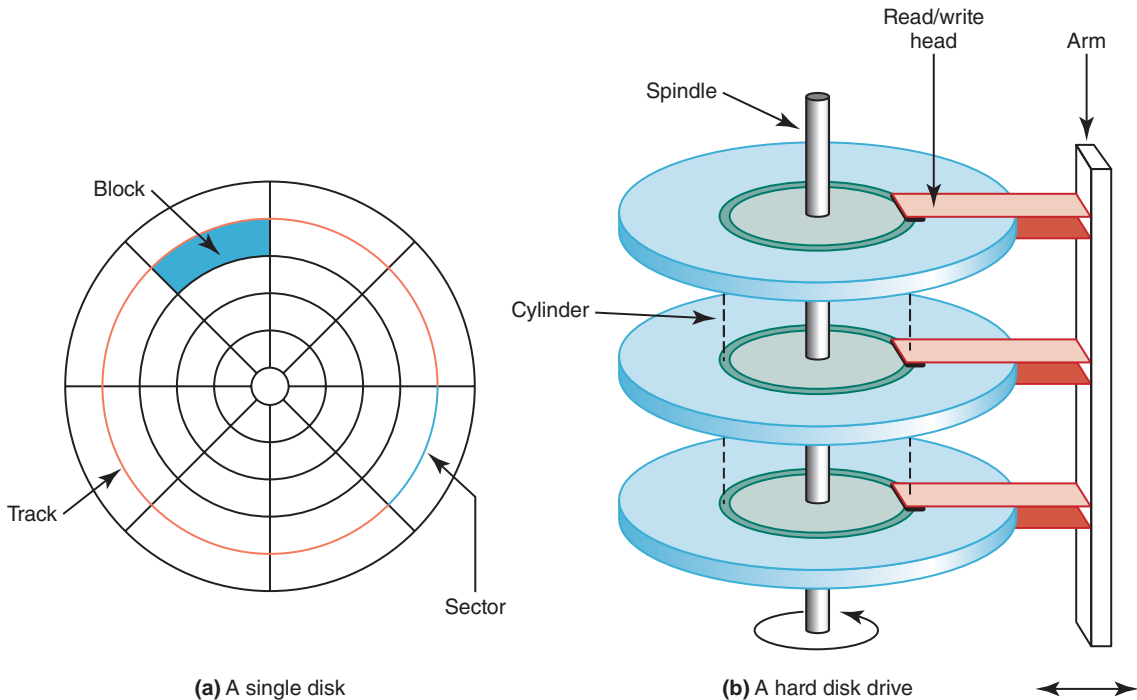


FIGURE 5.5 The organization of a magnetic disk

number of sectors per track vary, but 512 bytes or 1024 bytes is common. (The power of 2 strikes again.) The locations of the tracks and sectors are marked magnetically when a disk is formatted; they are not physically part of the disk.

The read/write head in a disk drive is positioned on an arm that moves from one track to another. See [FIGURE 5.5\(b\)](#). An input/output instruction specifies the track and sector. When the read/write head is over the proper track, it waits until the appropriate sector is beneath the head; it then accesses the block of information in that sector. This process gives rise to four measures of a disk drive's efficiency: **seek time**, **latency**, **access time**, and **transfer rate**. Seek time is the time it takes for the read/write head to get into position over the specified track. Latency is the time it takes for the specified sector to spin to the read/write head. The average latency is one-half the time for a full rotation of the disk. For this reason, latency is also called *rotation delay*. Access time is the sum of seek time and latency. Transfer rate is the rate at which data is transferred from the disk to memory.

Now let's look at some of the varieties of disks. One classification of disk is hard versus floppy. These terms refer to the flexibility of the disk itself. The original floppy disk, introduced in the 1970s, was 8" in diameter and even its case was floppy. By the time of the rise in personal computers in the late 1970s, the floppy disk had been reduced in size to 5 1/4" in diameter. Later, generic "floppy" disks were 3 1/2" in diameter, encased in a hard plastic cover, and capable of storing 1.44 MB of data. Floppy disks are no longer used in modern computers, having been replaced by removable storage such as flash drives (see below). Historically, though, they explain the use of the contrasting term *hard disks*.

Hard disks actually consist of several disks—this sounds strange, so let's explain. Let's call the individual disks *platters*. Hard disks consist of several platters attached to a spindle that rotates. Each platter has its own read/write head. All of the tracks that line up under one another are called a **cylinder** (see [Figure 5.5\(b\)](#)). An address in a hard drive consists of the cylinder number, the surface number, and the sector. Hard drives rotate at much higher speeds than floppy drives do, and the read/write heads don't actually touch the surface of the platters but rather float above them. A typical hard disk drive rotates at 7200 revolutions per minute. Laptop hard disks usually spin at 5400 RPM, conserving battery power. The disks in high-performance servers may run at 15,000 RPM, providing lower latency and a higher transfer rate.

Seek time The time it takes for the read/write head to get positioned over the specified track

Latency The time it takes for the specified sector to spin to the read/write head

Access time The time it takes for a block to start being read; the sum of seek time and latency

Transfer rate The rate at which data moves from the disk to memory

Cylinder The set of concentric tracks on all surfaces



E-vote glitch

In the 2004 presidential election, an error with an electronic voting system gave President Bush 3,893 extra votes in suburban Columbus, Ohio, elections officials said. Franklin County's unofficial results had Bush receiving 4,258 votes to Democrat John Kerry's 260 votes in a precinct in Gahanna. Records show only 638 voters cast ballots in that precinct. Bush actually received 365 votes in the precinct. (That still doesn't add up.)

CDs and DVDs

The world of compact discs and their drivers looks like acronym soup. The ad we examined used the acronym *DVD+/-RW*. In addition, we have to decipher *CD-DA*, *CD-RW*, and *DVD*.

Let's look for a moment at the acronym *CD*. *CD*, of course, stands for *compact disc*. A CD drive uses a laser to read information that is stored optically on a plastic disk. Rather than having concentric tracks, a CD has one track that spirals from the inside out. As on magnetic disks, this track is broken into sectors. A CD has the data evenly packed over the whole disk, so more information is stored in the track on the outer edges and read in a single revolution. To make the transfer rate consistent throughout the disk, the rotation speed varies depending on the position of the laser beam.

The other letters attached to *CD* refer to various properties of the disk, such as formatting and whether the information on the disk can be changed. *CD-DA* is the format used in audio recordings; *CD-DA* stands for *compact disc-digital audio*. Certain fields in this format are used for timing information. A sector in a *CD-DA* contains 1/75 of a second of music.

CD-ROM is the same as *CD-DA*, but the disk is formatted differently. Data is stored in the sectors reserved for timing information in *CD-DA*. *ROM* stands for *read-only memory*. As we said earlier, read-only memory means that the data is permanent and cannot be changed. A sector on a *CD-ROM* contains 2 KB of data. *CD-ROM* capacity is in the neighborhood of 600 MB.

CD-R stands for *recordable*, allowing data to be written after it is manufactured. The contents of a *CD-R* cannot be changed after data is recorded on it. A *CD-RW* is rewritable, meaning that it can have data recorded on it multiple times.

The most common format for distributing movies is now a *DVD*, which stands for *digital versatile disk* (although the acronym generally stands on its own these days). Because of its large storage capacity, a *DVD* is well suited to hold multimedia presentations that combine audio and video.

DVDs come in multiple forms: *DVD+R*, *DVD-R*, *DVD+RW*, and *DVD-RW*, and each of these may be preceded by *DL*. As we noted in describing the ad, the + and - refer to two competing formats. As with *CD*, *R* means recordable and *RW* means rewritable. *DL* stands for *dual layer*, which nearly doubles the capacity of a *DVD*. *DVD-R* has a capacity of 4.7 GB, while *DL DVD-R* can hold 8.5 GB. More recently, *Blu-Ray* disks with 25 GB capacity and *DL 50 GB* capacity have been introduced. Writable versions are also available. The name *Blu-Ray* refers to its use of a blue laser instead of the red laser in *CD* and *DVD* drives.

Note that the \times used in rating CD and DVD speeds (such as $8\times$ or $10\times$) indicates the relative speed of access compared with a standard CD or DVD player. When evaluating these devices, be aware that the higher speeds listed represent maximums that are usually attainable only when retrieving data from certain parts of the disk. They are not averages. Therefore, faster may not be better in terms of the added cost.

Flash Drives

IBM introduced the flash drive in 1998 as an alternative to floppy disks. **FIGURE 5.6** shows a flash drive (or thumb drive), which uses flash memory, a nonvolatile computer memory that can be erased and rewritten. To use a flash drive, it is simply plugged into a USB (universal serial bus) port.

Flash memory is also being used to build solid-state disks (SSDs) that can directly replace a hard disk. Because an SSD is all electronic and has no moving parts, it is faster and consumes less power than a hard disk. Even so, its storage elements can eventually wear out, meaning that it can suffer failures just as a hard disk can.



FIGURE 5.6 Flash drive
© Brian A. Jackson/Shutterstock

Touch Screens

We've seen how secondary memory devices provide locations in which to store programs and data used by the CPU. Other input/output (I/O) devices allow the human user to interact with an executing program. Many of these are commonplace—we often provide information through a keyboard and mouse, and we usually view information displayed on a monitor screen. Other input devices include bar code readers and image scanners; other output devices include printers and plotters.

Let's examine one particular type of I/O device in some detail. A *touch screen* displays text and graphics like a regular monitor, but it can also detect and respond to the user touching the screen with a finger or stylus. Usually, an I/O device serves either as an input device or an output device. A touch screen serves as both.

You've probably seen touch screens used in a variety of situations such as information kiosks, restaurants, and museums. **FIGURE 5.7** shows someone using a touch screen. These devices are most helpful in situations in which complex input is not needed, and they have the added benefit of being fairly well protected. It's far better for a waiter at a restaurant to make a few choices using a touch screen than to have to deal with a keyboard, which has more keys than necessary (for the task) and may easily get damaged from food and drink.



FIGURE 5.7 A touch screen

© Denys Prykhodov/Shutterstock

?

Virtual games and national security

U.S. and British spies have infiltrated the fantasy world of virtual games. A 2008 National Security Agency (NSA) document declared that virtual games provide a “target-rich communication network” that allows intelligence suspects a way to communicate and “hide in plain sight.”⁴

A touch screen not only detects the touch, but also knows where on the screen it is being touched. Choices are often presented using graphical buttons that the user selects by touching the screen where the button is positioned. In this sense, using a touch screen is not much different from using a mouse. The mouse position is tracked as the mouse is moved; when the mouse button is clicked, the position of the mouse pointer determines which graphical button is pushed. In a touch screen, the location at which the screen is touched determines which button is pushed.

So how does a touch screen detect that it is being touched? Furthermore, how does it know where on the screen it is being touched? Several technologies are used today to implement touch screens. Let’s briefly explore them.

A *resistive* touch screen is made up of two layers—one with vertical lines and one with horizontal lines of electrically conductive material. The two layers are separated by a very small amount of space. When the top layer is pressed, it comes in contact with the second layer, which allows electrical current to flow. The specific vertical and horizontal lines that make contact dictate the location on the screen that was touched.

A *capacitive* touch screen has a laminate applied over a glass screen. The laminate conducts electricity in all directions, and a very small current is applied equally on the four corners. When the screen is touched, current flows to the finger or stylus. The current is so low that the user doesn’t even feel it. The location of the touch on the screen is determined by comparing the strength of the flow of electricity from each corner.

An *infrared* touch screen projects crisscrossing horizontal and vertical beams of infrared light just over the surface of the screen. Sensors on opposite sides of the screen detect the beams. When the user breaks the beams by touching the screen, the location of the break can be determined.

A *surface acoustic wave* (SAW) touch screen is similar to an infrared touch screen except that it projects high-frequency sound waves across the horizontal and vertical axes. When a finger touches the surface, the corresponding sensors detect the interruption and determine the location of the touch.

Note that a gloved hand could be used in resistive, infrared, and SAW touch screens, but cannot be used with capacitive screens, which rely on current flowing to the touch point.

5.3 Embedded Systems

Embedded systems are computers that are designed to perform a narrow range of functions as part of a larger system. Typically, an embedded system is housed on a single microprocessor chip with the programs stored in ROM. Virtually all appliances that have a digital interface—watches, microwaves, VCRs, cars—utilize embedded systems. In fact, embedded systems are everywhere: From consumer electronics to kitchen appliances, to automobiles, to networking equipment, to industrial control systems, you find embedded systems lurking in the device. Some embedded systems include an operating system, but many are so specialized that the entire logic can be implemented as a single program.⁵

Early embedded systems were stand-alone 8-bit microprocessors with their own homegrown operating system. Today, they range from 8-bit controllers to 32-bit digital signal processors (DSPs) to 64-bit RISC (reduced instruction set computer) chips. More and more embedded systems are based on networks of distributed microprocessors that communicate through wired and wireless buses, remotely monitored and controlled by regular network management communications protocols.

In fact, the term *embedded system* is nebulous because it encompasses just about everything except desktop PCs. The term originated because the first such computers were physically embedded within a product or device and could not be accessed. Now the term refers to any computer that is preprogrammed to perform a dedicated or narrow range of functions as part of a larger system. The implication is that there is only minimal end-user or operator intervention, if any.

Because the average person encounters an embedded system only in his or her kitchen, entertainment room, or car, we tend to equate these systems with hardware. In reality, programs must be written and burned

into the read-only memory that comes with the system to make it accomplish its assigned function. Given that programs cannot be developed and tested on the embedded processor itself, how are they implemented? Programs are written on a PC and compiled for the target system, where the executable code is generated for the processor in the embedded system.

In early embedded systems, the size of the code and the speed at which it executed were very important. Because assembly-language programs provided the best opportunity to streamline and speed up the code, they were used almost exclusively for embedded systems. Even when the C language became popular and cross-compilers for C to embedded systems became available, many programmers continued to use assembly language for this purpose. C programs are approximately 25% larger and slower, but are easier to write than assembly-language programs. Even today, the size of the ROM may dictate that the code be as small as possible, leading to an assembly-language program.⁶

5.4 Parallel Architectures⁷

If a problem can be solved in n time units on a computer with one processor (von Neumann machine), can it be solved in $n/2$ time units on a computer with two processors, or $n/3$ on a computer with three processors? This question has led to the rise of parallel computing architectures.

Parallel Computing

There are four general forms of parallel computing: bit level, instruction level, data level, and task level.

Bit-level parallelism is based on increasing the word size of a computer. In an 8-bit processor, an operation on a 16-bit data value would require two operations: one for the upper 8 bits and one for the lower 8 bits. A 16-bit processor could do the operation in one instruction. Thus, *increasing* the word size *reduces* the number of operations on data values larger than the word size. The current trend is to use 64-bit processors.

Instruction-level parallelism is based on the idea that some instructions in a program can be carried out independently in parallel. For example, if a program requires operations on unrelated data, these operations can be done at the same time. A superscalar is a processor that can recognize this situation and take advantage of it by sending instructions to different functional units of the processor. Note that a superscalar machine does not have multiple processors but does have multiple execution resources. For example, it might contain separate ALUs for working on integers and real numbers, enabling it to simultaneously compute the sum of two integers and the product of two real numbers. Such resources are called *execution units*.

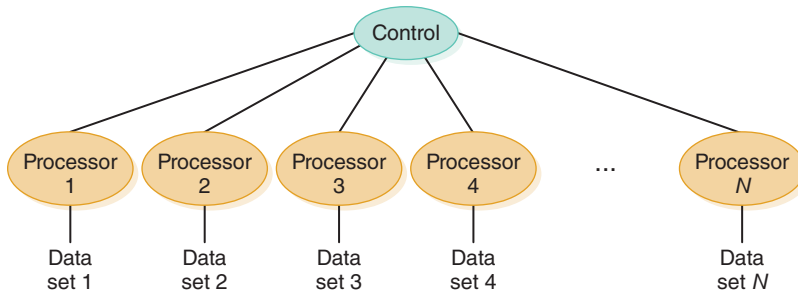


FIGURE 5.8 Processors in a synchronous computing environment



FIGURE 5.9 Processors in a pipeline

Data-level parallelism is based on the idea that a single set of instructions can be run on different data sets at the same time. This type of parallelism is called *SIMD* (single instructions, multiple data) and relies on a control unit directing multiple ALUs to carry out the same operation, such as addition, on different sets of operands. This approach, which is also called **synchronous processing**, is effective when the same process needs to be applied to many data sets. For example, increasing the brightness of an image involves adding a value to every one of several million pixels. These additions can all be done in parallel. See [FIGURE 5.8](#).

Task-level parallelism is based on the idea that different processors can execute different tasks on the same or different data sets. If the different processors are operating on the same data set, then it is analogous to pipelining in a von Neumann machine. When this organization is applied to data, the first processor does the first task. Then the second processor starts working on the output from the first processor, while the first processor applies its computation to the next data set. Eventually, each processor is working on one phase of the job, each getting material or data from the previous stage of processing, and each in turn handing over its work to the next stage. See [FIGURE 5.9](#).

In a data-level environment, each processor is doing the same thing to a different data set. For example, each processor might be computing the grades for a different class. In the pipelining task-level example, each processor is contributing to the grade for the same class. Another approach to task-level parallelism is to have different processors doing different things with different data. This configuration allows processors to work independently much of the time, but introduces problems of coordination among the processors. This leads to a configuration where each of the

Synchronous processing Multiple processors apply the same program in lockstep to multiple data sets

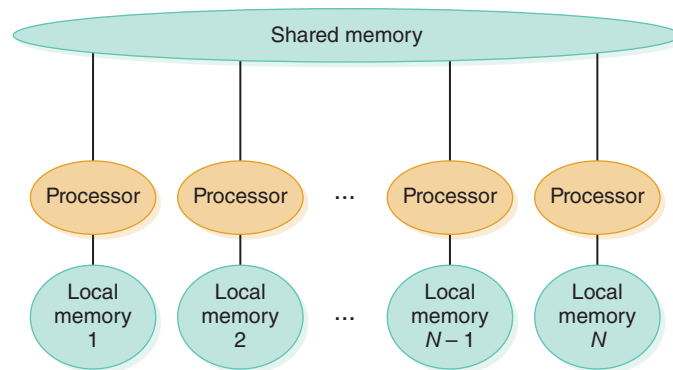


FIGURE 5.10 A shared-memory parallel processor

Shared memory parallel processor

The situation in which multiple processors share a global memory

processors have both a local memory and a shared memory. The processors use the shared memory for communication, so the configuration is called a **shared memory parallel processor**. See [FIGURE 5.10](#).

Classes of Parallel Hardware

The classes of parallel hardware reflect the various types of parallel computing. Multicore processors have multiple independent cores, usually CPUs. Whereas a superscalar processor can issue multiple instructions to execution units, each multicore processor can issue multiple instructions to multiple execution units. That is, each independent core can have multiple execution units attached to it.

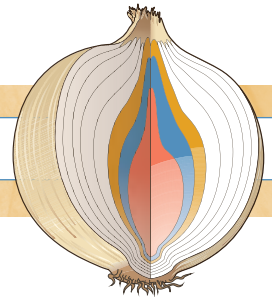
Symmetric multiprocessors (SMPs) have multiple identical cores. They share memory, and a bus connects them. The number of cores in an SMP is usually limited to 32 processors. A distributed computer is one in which multiple memory units are connected through a network. A cluster is a group of stand-alone machines connected through an off-the-shelf network. A massively parallel processor is a computer with many networked processors connected through a specialized network. This kind of device usually has more than 1000 processors.

The distinctions between the classes of parallel hardware are being blurred by modern systems. A typical processor chip today contains two to eight cores that operate as an SMP. These are then connected via a network to form a cluster. Thus, it is common to find a mix of shared and distributed memory in parallel processing. In addition, graphics processors that support general-purpose data-parallel processing may be connected to each of the multicore processors. Given that each of the cores is also applying instruction-level parallelism, you can see that modern parallel computers no longer fall into one or another specific classification. Instead,

they typically embody all of the classes at once. They are distinguished by the particular balance that they strike among the different classes of parallel processing they support. A parallel computer that is used for science may emphasize data parallelism, whereas one that is running an Internet search engine may emphasize task-level parallelism.

© Artur Debat/Getty Images, © Alan Dyer/Stocktrek Images/Getty Images

SUMMARY



The components that make up a computer cover a wide range of devices. Each component has characteristics that dictate how fast, large, and efficient it is. Furthermore, each component plays an integral role in the overall processing of the machine.

The world of computing is filled with jargon and acronyms. The speed of a processor is specified in GHz (gigahertz); the amount of memory is specified in MB (megabytes), GB (gigabytes), and TB (terabytes); and a display screen is specified in pixels.

The von Neumann architecture is the underlying architecture of most of today's computers. It has five main parts: memory, the arithmetic/logic (ALU) unit, input devices, output devices, and the control unit. The fetch–execute cycle, under the direction of the control unit, is the heart of the processing. In this cycle, instructions are fetched from memory, decoded, and executed.

RAM and ROM are acronyms for two types of computer memory. RAM stands for *random-access memory*; ROM stands for *read-only memory*. The values stored in RAM can be changed; those in ROM cannot.

Secondary storage devices are essential to a computer system. These devices save data when the computer is not running. Magnetic tape, magnetic disk, and flash drives are three common types of secondary storage.

Touch screens are peripheral devices that serve both input and output functions and are appropriate in specific situations such as restaurants and information kiosks. They respond to a human touching the screen with a finger or stylus, and they can determine the location on the screen where the touch occurred. Several touch screen technologies exist, including resistive, capacitive, infrared, and surface acoustic wave (SAW) touch screens. They have varying characteristics that make them appropriate in particular situations.

Although von Neumann machines are by far the most common, other computer architectures have emerged. For example, there are machines with more than one processor so that calculations can be done in parallel, thereby speeding up the processing.



ETHICAL ISSUES

Is Privacy a Thing of the Past?

“Personal privacy is all but dead and gone, and we’re the worse for it, in my opinion,” wrote Austin Bay in the *Austin American-Statesman* on December 27, 2013. Bay contends that the long goodbye to privacy began with Johannes Gutenberg’s invention of the printing press in 1450, which brought us mass literacy with the side effect of making gossip “permanent.” Later came the camera, a powerful anti-privacy weapon for paparazzi. The telegraph and the telephone gave gossip global reach. Personal information and innuendos now move “at the speed of light,” Bay writes.

Bay goes on to discuss what he calls privacy’s “shadowy twin”: institutional and state secrecy. He contends that state and institutional secrecy have not expired but may be on life support. Innovative hackers have in

the past two decades proven that the repositories of modern information—computers and the Internet—are breachable. NSA contractor Edward Snowden demonstrated the failure of states to keep their secrets in 2013, when he released the documents he had stolen. Private investigators in Great Britain are on trial for hacking the personal phones of the British royals. Target and Neiman Marcus have lost the personal information of millions of customers.

Bay’s editorial is somewhat tongue in cheek, but it is an intriguing concept that privacy and secrecy are no longer possible in today’s world. Is this an example of unexpected consequences? The printing press began the process of mass literacy, which eventually resulted in the loss of privacy.

© Artur Debat/Getty Images; © Alan Dyer/Stocktrek Images/Getty Images

KEY TERMS

Access time
Addressability
Arithmetic/logic unit (ALU)
Block
Bus width
Cache memory
Control unit
CPU

Cylinder
Input unit
Instruction register (IR)
Latency
Motherboard
Output unit
Pipelining
Program counter (PC)

KEY TERMS (CONTINUED)

Register
Sector
Seek time
Shared memory parallel processor

Synchronous processing
Track
Transfer rate

EXERCISES

For Exercises 1–16, match the power of 10 to its name or use.

- A. 10^{-12}
- B. 10^{-9}
- C. 10^{-6}
- D. 10^{-3}
- E. 10^3
- F. 10^6
- G. 10^9
- H. 10^{12}
- I. 10^{15}

1. Nano-
2. Pico-
3. Micro-
4. Milli-
5. Tera-
6. Giga-
7. Kilo-
8. Mega-
9. Often used to describe processor speed
10. Often used to describe size of memory
11. Used in relation to Internet speeds
12. Latin for “thousandth”

13. Italian for “little”
14. Peta-
15. Roughly equivalent to 2^{10}
16. Roughly equivalent to 2^{50}

For Exercises 17–23, match the acronym with its most accurate definition.

- A. CD-ROM
 - B. CD-DA
 - C. CD-R
 - D. DVD
 - E. CD-RW
 - F. DL DVD
 - G. Blu-Ray
17. Format using two layers
 18. Data is stored in the sectors reserved for timing information in another variant
 19. Can be read many times, but written after its manufacture only once
 20. Can be both read from and written to any number of times
 21. Format used in audio recordings
 22. A new technology storing up to 50 GB
 23. The most popular format for distributing movies

EXERCISES (CONTINUED)

Exercises 24–66 are problems or short-answer exercises.

24. Define the following terms:
 - a. Core 2 processor
 - b. Hertz
 - c. Random access memory
25. What does *FSB* stand for?
26. What does it mean to say that a processor is 1.4 GHz?
27. What does it mean to say that memory is 133 MHz?
28. How many bytes of memory are there in the following machines?
 - a. 512 MB machine
 - b. 2 GB machine
29. Define *RPM* and discuss what it means in terms of speed of access to a disk.
30. What is the stored-program concept, and why is it important?
31. What does “units that process information are separate from the units that store information” mean in terms of computer architecture?
32. Name the components of a von Neumann machine.
33. What is the addressability of an 8-bit machine?
34. What is the function of the ALU?
35. Which component in the von Neumann architecture would you say acts as the stage manager? Explain.
36. Punched cards and paper tape were two early input/output media. Discuss their advantages and disadvantages.
37. What is an instruction register, and what is its function?
38. What is a program counter, and what is its function?
39. List the steps in the fetch–execute cycle.
40. Explain what is meant by “fetch an instruction.”
41. Explain what is meant by “decode an instruction.”
42. Explain what is meant by “execute an instruction.”
43. Compare and contrast RAM and ROM.
44. What is a secondary storage device, and why are such devices important?
45. Discuss the pros and cons of using magnetic tape as a storage medium.
46. What are the four measures of a disk drive’s efficiency?
47. Define what is meant by a block of data.
48. What is a cylinder?
49. Define the steps that a hard disk drive goes through to transfer a block of data from the disk to memory.
50. Distinguish between a compact disc and a magnetic disk.
51. Describe a parallel architecture that uses synchronous processing.
52. Describe a parallel architecture that uses pipeline processing.
53. How does a shared-memory parallel configuration work?
54. How many different memory locations can a 16-bit processor access?

EXERCISES (CONTINUED)

55. Why is a faster clock not always better?
56. Why is a larger cache not necessarily better?
57. In the ad, why is the 1080p specification for the screen not entirely true?
58. Keep a diary for a week of how many times the terms *hardware* and *software* appear in commercials on TV shows you are watching.
59. Take a current ad for a laptop computer and compare that ad with the one shown at the beginning of this chapter.
60. What is the common name for the disk that is a secondary storage device?
61. To what does the term *pixels* refer?
62. What is a GPU?
63. If a battery in a laptop is rated for 80 WHr, and the laptop draws 20 watts, how long will it run?
64. What is the difference between 1K of memory and a 1K transfer rate?
65. Compare and contrast a DVD-ROM and a flash drive.
66. *Giga-* can mean both 10^9 and 2^{30} . Explain to what each refers. Can this cause confusion when reading a computer advertisement?

THOUGHT QUESTIONS

1. Has your personal information ever been stolen? Has any member of your family experienced this?
2. How do you feel about giving up your privacy for the sake of convenience?
3. *All secrets are not equal.* How does this statement relate to issues of privacy?
4. People post all sorts of personal information on social media sites. Does this mean they no longer consider privacy important?

Laying the Groundwork

- 1 The Big Picture

The Information Layer

- 2 Binary Values and Number Systems
- 3 Data Representation

The Hardware Layer

- 4 Gates and Circuits
- 5 Computing Components

The Programming Layer

- 6 Low-Level Programming Languages and Pseudocode
- 7 Problem Solving and Algorithms
- 8 Abstract Data Types and Subprograms
- 9 Object-Oriented Design and High-Level Programming Languages

The Operating Systems Layer

- 10 Operating Systems
- 11 File Systems and Directories

The Applications Layer

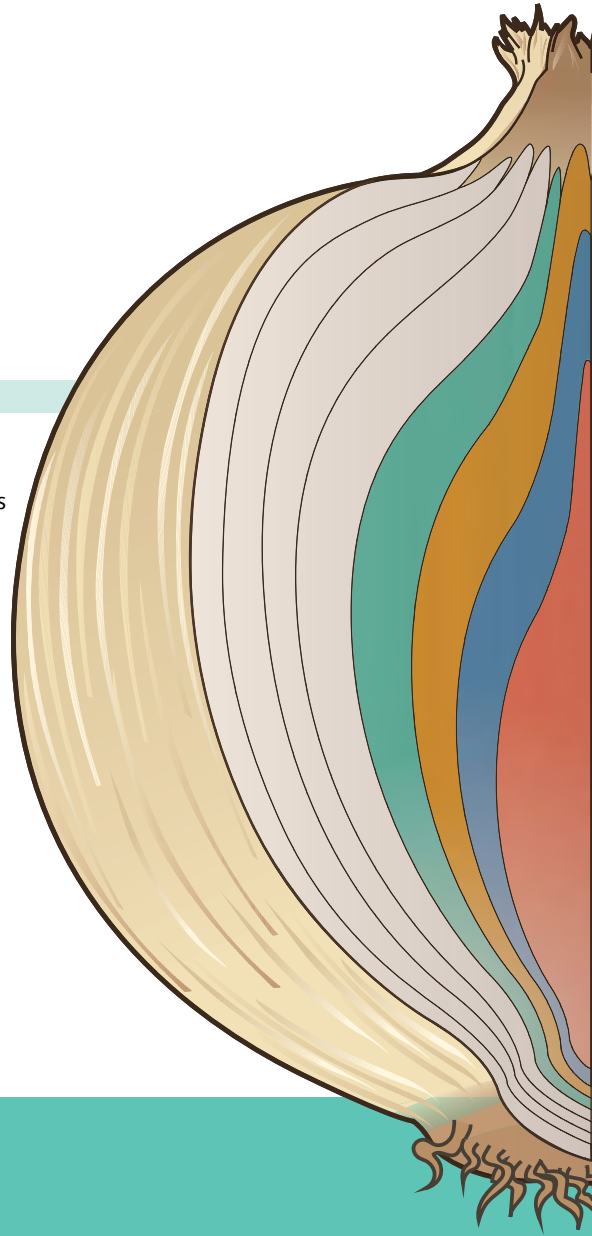
- 12 Information Systems
- 13 Artificial Intelligence
- 14 Simulation, Graphics, Gaming, and Other Applications

The Communications Layer

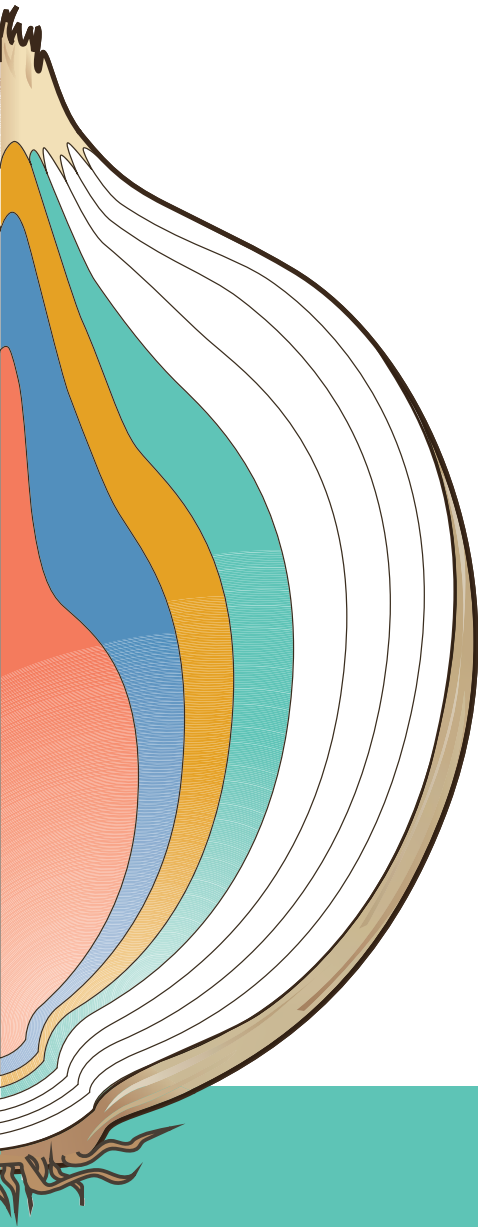
- 15 Networks
- 16 The World Wide Web
- 17 Computer Security

In Conclusion

- 18 Limitations of Computing



THE PROGRAMMING LAYER



LOW-LEVEL PROGRAMMING LANGUAGES AND PSEUDOCODE

6

Chapter 6 is the first chapter in the programming layer. In Chapters 2 and 3, we covered the basic information necessary for understanding a computing system, including number systems and ways to represent different types of information in a computer. In Chapters 4 and 5, we covered the hardware components of a computer. Now the emphasis changes from what a computer system is to how it helps us solve problems.

We begin this chapter by looking at machine code, the lowest-level programming language of all—the language that actually runs on the computer's central processing unit (CPU). We then move up one level to assembly language, a language in which we can use a combination of letters to represent a machine-language instruction. Finally, we introduce the concept of pseudocode as a way to express algorithms.

GOALS

After studying this chapter, you should be able to:

- distinguish between machine language and assembly language.
- describe the important features of the Pep/9 virtual machine.
- distinguish between immediate addressing mode and direct addressing mode.
- write a simple machine-language program.
- use the Pep/9 simulator to run machine-language and assembly-language programs.
- describe the steps in creating and running an assembly-language program.
- write a simple program in assembly language.
- distinguish between instructions to the assembler and instructions to be translated.
- distinguish between following an algorithm and developing one.
- describe the pseudocode constructs used in expressing an algorithm.
- use pseudocode to express an algorithm.
- describe two approaches to testing.
- design and implement a test plan for a simple assembly-language program.

6.1 Computer Operations

The programming languages we use must mirror the types of operations that a computer can perform. So let's begin our discussion by repeating the definition of a computer: A computer is a programmable electronic device that can store, retrieve, and process data.

The operational words here are *programmable*, *store*, *retrieve*, and *process*. In a previous chapter we pointed out the importance of the realization that data and instructions to manipulate the data are logically the same and could be stored in the same place. That is what the word *programmable* means in this context. The instructions that manipulate data are stored within the machine along with the data. To change what the computer does to the data, we change the instructions.

Store, *retrieve*, and *process* are actions that the computer can perform on data. That is, the instructions that the control unit executes can store data into the memory of the machine, retrieve data from the memory of the machine, and process the data in some way in the arithmetic/logic unit. The word *process* is very general. At the lowest level, processing involves performing arithmetic and logical operations on data values.

Furthermore, the data has to get into the computer memory initially, and we need a way for the human user to see whatever results we want to present. So, there are also instructions that specify the interaction between an input device and the CPU and between the CPU and an output device.

6.2 Machine Language

As we pointed out in Chapter 1, the only programming instructions that a computer actually carries out are those written using **machine language**, the instructions built into the hardware of a particular computer. When computers were first created, humans had no choice except to write programs in machine language because other programming languages had not yet been invented.

So how are computer instructions represented? Recall that every processor type has its own set of specific machine instructions. These are the only instructions the processor can actually carry out. Because a finite number of instructions exist, the processor designers simply list the instructions and assign them a binary code that is used to represent them. This is similar to the approach taken when representing character data, as described in Chapter 3.

The relationship between the processor and the instructions it can carry out is completely integrated. The electronics of the CPU inherently

Machine language

The language made up of binary-coded instructions that is used directly by the computer

recognize the binary representations of the specific commands, so there is no actual list of commands the computer must consult. Instead, the CPU embodies the list in its design.

Each machine-language instruction performs one very low-level task. Each small step in a process must be explicitly coded in machine language. Even the small task of adding two numbers together must be broken down into smaller steps: Enter a number into the accumulator, add a number to it, save the result. Each instruction is expressed in the appropriate string of binary digits.

Keep in mind that very few programs are written in machine language today, primarily because they represent an inefficient use of a programmer's time. Although most programs are written in higher-level languages, they are eventually translated into machine language in order to be executed. Understanding the basics of machine language will explain the way a computer actually accomplishes its tasks and will make you appreciate the relative ease with which people program computers today.

Pep/9: A Virtual Computer

By definition, machine code differs from machine to machine. That is, each type of CPU has its own machine language that it understands. So how can we give you the experience of using machine language when you may be working on different machines? We solve that problem by using a **virtual computer**. A virtual computer is a hypothetical machine—in this case, one that is designed to contain the important features of real computers that we want to illustrate. Pep/9, designed by Stanley Warford, is the virtual machine that we use here.¹

Pep/9 has 40 machine-language instructions. This means that a program for Pep/9 must be a sequence consisting of a combination of these instructions. Don't panic: We will not ask you to understand and remember 40 sequences of binary bits! We merely plan to examine a few of these instructions, and we will not ask you to memorize any of them.

Basic Features of Pep/9

The memory unit of the Pep/9 is made up of 65,536 bytes of storage. The bytes are numbered from 0 through 65,535 (decimal). Recall that each byte contains 8 bits, so we can describe the bit pattern in a byte using two hexadecimal digits. (Refer to Chapter 2 for more information on hexadecimal digits.) The word length in Pep/9 is 2 bytes, or 16 bits. Thus the information that flows into and out of the arithmetic/logic unit (ALU) is 16 bits in length.

Managing endangered species

Zoos have established captive populations of endangered animals to save them from extinction, but they need to have a good distribution of ages and genetic diversity to protect the species against diseases and inbreeding. A computerized database of all captive animals enables scientists to measure important factors governing the welfare of a species. The Minnesota Zoological Garden coordinates the International Species Inventory System, which provides global information on more than 2.2 million living animals.

Virtual computer (machine) A hypothetical machine designed to illustrate important features of a real machine

Chapter 6: Low-Level Programming Languages and Pseudocode

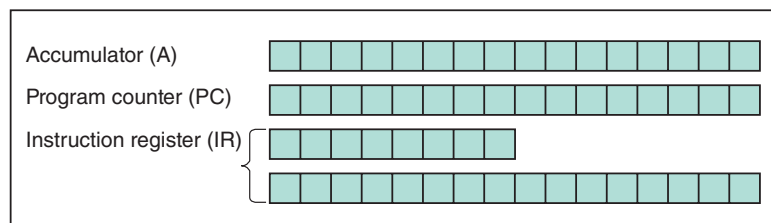
Recall from Chapter 5 that a *register* is a small area of storage in the ALU that holds special data and intermediate values. Pep/9 has seven registers, three of which we focus on at this point:

- The program counter (PC), which contains the address of the next instruction to be executed
- The instruction register (IR), which contains a copy of the instruction being executed
- The accumulator (A), which holds data and the results of operations

FIGURE 6.1 shows a diagram of Pep/9's CPU and memory. The addresses in memory are shown in orange to emphasize that the addresses themselves are not stored in memory, but rather that they *name* the individual bytes of memory. We refer to any particular byte in memory by its address. It's important to distinguish between the address of a memory location and the value that is stored there.

Before we go on, let's review some aspects of binary and hexadecimal numbers. The largest decimal value that can be represented in a byte is 255. It occurs when all of the bits are 1s: 11111111 in binary is FF in hexadecimal and 255 in decimal. The largest decimal value that can be represented in a word (16 bits) is 65,535. It occurs when all 16 bits are 1s: 1111111111111111 in binary is FFFF in hexadecimal and 65,535 in decimal. If we represent both positive and negative numbers, we lose a bit in the magnitude (because one is used for the sign), so we can represent values ranging from $-7FFF$ to $+7FFF$ in hexadecimal, or $-32,767$ to $+32,767$ in decimal.

Pep/9's CPU (as discussed in this chapter)



Pep/9's Memory

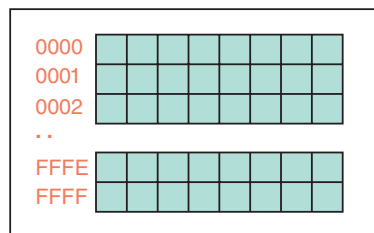


FIGURE 6.1 Pep/9's architecture

This information is important when working with the Pep/9 machine. The number of bits we have available determines the size of the numbers we can work with.

Instruction Format

We're almost ready to look at a subset of the instructions that the Pep/9 computer can execute. First, however, we need to examine the format of an instruction in Pep/9.

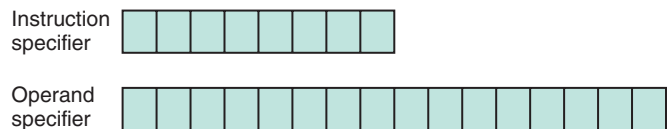
FIGURE 6.2(a) shows the format for an instruction in Pep/9. There are two parts to an instruction: the 8-bit *instruction specifier* and (optionally) the 16-bit *operand specifier*. So a Pep/9 instruction is either 1 byte or 3 bytes in length, depending on whether an operation specifier is needed.

The instruction specifier indicates which operation is to be carried out, such as “add a number (the operand) to a value already stored in a register,” and how to interpret where the operand is. The operand specifier holds either the operand itself or the address of where the operand is to be found. Some instructions do not have an operand specifier.

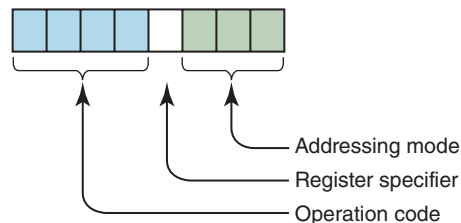
The format of the instruction specifier is shown in FIGURE 6.2(b). In Pep/9, *operation codes* (called *opcodes*) vary from 4 bits to 8 bits long, but the only opcodes that we cover in this chapter are 4 bits long. The 5th bit is the register specifier, which will always be 0 in our examples to indicate the A register (the accumulator).

The 3-bit *addressing mode specifier* (shaded green) indicates how to interpret the contents of the operand specifier. If the addressing mode is 000, the operand specifier contains a data value to be used as the operand of the instruction. This addressing mode is called *immediate* (i). If the addressing mode is 001, the operand specifier contains a memory address. This addressing mode is called *direct* (d). (Other addressing modes also exist, but we do not cover them here.) See FIGURE 6.3. Memory addresses are shaded in orange; operands are shaded in gray.

Instructions that do not have an operand (data to be manipulated) are called *unary instructions*; they do not have an operand specifier. That is, unary instructions are only 1 byte long rather than 3 bytes long.



(a) The two parts of an instruction



(b) The instruction specifier part of an instruction

FIGURE 6.2 Pep/9 instruction format

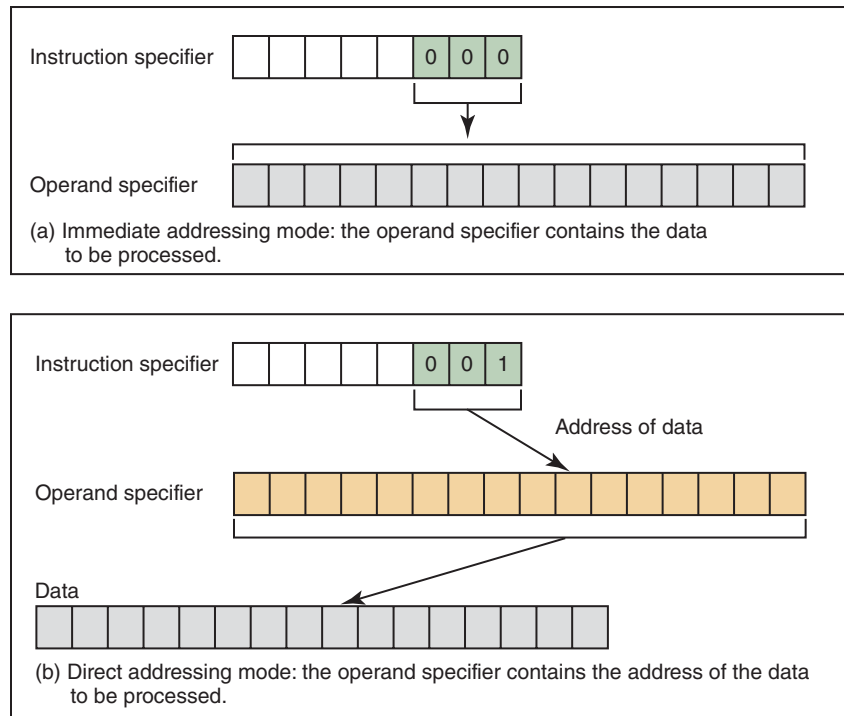


FIGURE 6.3 The difference between immediate addressing mode and direct addressing mode

Some Sample Instructions

Let's look at some specific instructions in isolation and then put them together to write a program. FIGURE 6.4 shows the operation code (or *opcode*) for the operations we are covering.

Opcode	Meaning of Instruction
0000	Stop execution
1100	Load word into the A register
1101	Load byte into the A register
1110	Store word from the A register
1111	Store byte from the A register
0110	Add the operand to the A register
0111	Subtract the operand from the A register

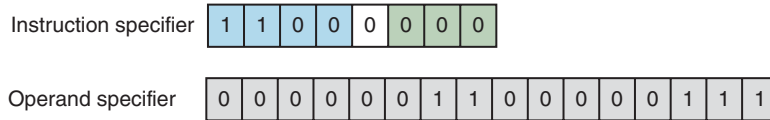
FIGURE 6.4 Subset of Pep/9 instructions

0000 Stop execution During the fetch-execute cycle, when the operation code is all zeros, the program halts. *Stop* is a unary instruction, with no operand specifier. The three rightmost bits in the instruction specifier, which would otherwise indicate the addressing mode, are ignored.

1100 Load word into the A register This instruction loads one word (two bytes) into the A register. The addressing mode determines where the word to be loaded

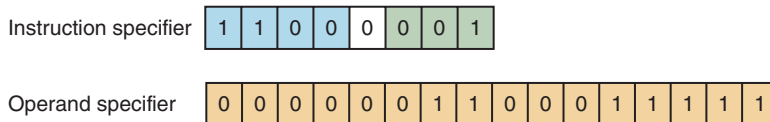
is located. That is, the value to be loaded is either the actual value in the operand specifier or it is in the memory location of the address found in the operand specifier.

Let's look at concrete examples of these options. Here is the first 3-byte instruction:



The addressing mode is immediate, meaning that the value to be loaded into the A register is in the operand specifier. The data is in the operand specifier, so it is shaded gray. When this instruction is executed, the contents of the second and third bytes of the instruction (the operand specifier) would be loaded into the A register (the accumulator). That is, the previous contents of the A register would be overwritten with the value 0307 (hex).

Here is another load instruction:



In this case, the addressing mode is direct, which means that the operand itself is not in the operand specifier; instead, the operand specifier holds the *address* (orange) of where the operand resides in memory. Thus, when this instruction is executed, the contents of *location* 001F would be loaded into the A register. This instruction loads a word (2 bytes), so when an address is used to specify the operand, as in this case, the address given is of the leftmost byte in the word. Thus the contents of adjacent locations 001F and 0020 are loaded into the A register. The contents of those memory locations are not changed.

1101 Load byte into the A register This instruction is like the load word instruction we just covered, but it loads only 1 byte instead of 2 bytes (one word).

If the addressing mode is immediate, the first byte of the operand specifier is ignored, and only the second byte of the operand specifier is loaded into the A register. If the addressing mode is direct, only 1 byte is loaded from the memory location specified instead of 2 bytes.

This instruction is useful when loading character data, as we'll see in upcoming examples.

1110 Store word from the A register This instruction stores the entire contents of the A register into the memory location specified in the operand.

Instruction specifier

1	1	1	0	0	0	0	1
---	---	---	---	---	---	---	---

Operand specifier

0	0	0	0	0	0	0	0	0	0	0	0	0	1	0	1	0
---	---	---	---	---	---	---	---	---	---	---	---	---	---	---	---	---

This instruction stores the contents of the A register into the word beginning at location 000A. It is invalid to use an immediate addressing mode with a store opcode because we cannot store the contents of a register into the operand specifier.

1111 Store byte from the A register This instruction is like the store word instruction we just covered, but it stores only 1 byte instead of 2 bytes (one word). Like the store word instruction, it does not support immediate addressing mode.

When this instruction executes, only the second byte of the A register (the accumulator) is stored in the address given in the operand specifier. The first 8 bits of the accumulator are ignored.

Like the load byte instruction, this instruction is useful when processing character data. We'll explore character I/O after discussing the last two instructions in our list.

0110 Add the operand to the A register Like the load operation, the add operation uses the addressing mode specifier, giving alternative interpretations. Here's an example of the first alternative, using immediate addressing mode:

Instruction specifier

0	1	1	0	0	0	0	0
---	---	---	---	---	---	---	---

Operand specifier

0	0	0	0	0	0	0	1	0	0	0	0	0	1	0	1	0
---	---	---	---	---	---	---	---	---	---	---	---	---	---	---	---	---

When this instruction is executed, the value in the operand specifier (020A in hex) is added into the contents of the A register. Now let's look at an add operation that uses direct addressing mode:

Instruction specifier

0	1	1	0	0	0	0	1
---	---	---	---	---	---	---	---

Operand specifier

0	0	0	0	0	0	0	1	0	0	0	0	0	1	0	1	0
---	---	---	---	---	---	---	---	---	---	---	---	---	---	---	---	---

Because the address mode specifier is direct, the contents of the operand specifier are treated as an address (location 020A). When the instruction executes, whatever value that is stored at that location in memory is added into the A register.



Bring a hammer

When Jan Hein Donner, the Dutch chess grandmaster, was asked how he would prepare for a chess match against a computer like IBM's Deep Blue, he replied, "I would bring a hammer."²

0111 Subtract the operand from the A register This instruction is just like the add operation, except that the operand is subtracted from the A register rather than added. As with the load and add operations, both immediate and direct addressing modes are supported.

Input and Output in Pep/9

The Pep/9 system simulates the ability to read character input from the keyboard and write character output to the screen (the terminal window). Although this process is simulated, like everything else in the Pep/9 virtual machine, it follows common computer systems design techniques.

In the case of input and output (I/O), the design principle followed is called *memory-mapped I/O*, which wires input and output devices to specific, fixed addresses in main memory. In Pep/9, the input device is at address FC15 and the output device is at address FC16.

To read a character from the input device, you load the value from the input device address into the accumulator (A register). To write a character to the output device, you load the character value into the accumulator and then store the value of the accumulator to the output device address. These operations are specific examples of the load byte and store byte instructions discussed earlier.

Pep/9 uses the ASCII character set (discussed in Chapter 3) to represent characters. Each ASCII character is represented by a single byte, so we use the load byte and store byte operations to perform character I/O in Pep/9 instead of the versions of those instructions that manipulate full words.

We'll see this I/O processing in action in the upcoming examples.

6.3 A Program Example

We are now ready to write our first machine-language program, which will be to write "Hi" to the screen. We'll need five machine-language instructions to do this: two loads, two stores, and one to stop the program execution.

First consideration: should we store the character data in memory and load it using direct addressing mode, or should we store it in the operand specifier and use immediate addressing mode? We'll use immediate addressing in this example and leave direct addressing as an exercise. So, for this example, when we load the characters the addressing mode specifier will be 000 and the ASCII code for each letter will go directly in the operand specifier (the second and third byte of the load

Chapter 6: Low-Level Programming Languages and Pseudocode

instruction—and because an ASCII character takes up only 1 byte, it really affects only the third byte).

Here are the program statements written in both binary and hexadecimal:

Action	Binary Instruction	Hex Instruction
Load 'H' into accumulator	1101 0000 0000 0000 0100 1000	D0 00 48
Store byte from accumulator to output device	1111 0001 1111 1100 0001 0110	F1 FC 16
Load 'i' into accumulator	1101 0000 0000 0000 0110 1001	D0 00 69
Store byte from accumulator to output device	1111 0001 1111 1100 0001 0110	F1 FC 16
Stop	0000 0000	00

Remember that the binary and hex columns represent the same values. The hex version is just a more succinct way to represent the data. The binary digits are shown in groups of four so that it's easier to see how they map to their hexadecimal equivalent.

For each binary instruction, the first row represents the 8-bit instruction specifier and the second row represents the 16-bit operand specifier. As before, the instruction opcode is shown in blue and the addressing mode in green.

As discussed in the previous section, to perform character output we use store instructions that write the character data from the accumulator directly to the address that represents the output device (FC16). Furthermore, we have to use the version of the store instruction that stores a single byte. Similarly, the load instructions used in this program are the version that load a single byte.

Pep/9 Simulator

Recall that Pep/9 is a virtual machine, meaning it doesn't exist as a physical computer in real life. However, we can make use of the Pep/9 simulator, which is a program that behaves the way the virtual machine is designed to behave. The Pep/9 simulator can be downloaded for free.

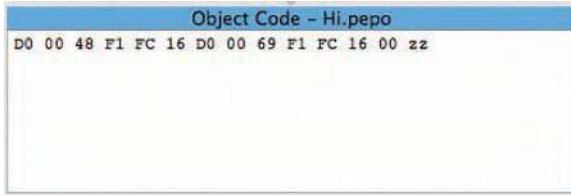
To run a Pep/9 machine-language program, we enter the hexadecimal code for the program byte by byte into a window labeled *Object Code*. (We'll explore that term in the next section.) The format of

?

Nigerian check scam

In June 2008, Edna Fiedler of Olympia, Washington, was sentenced to 2 years in prison and 5 years of supervised probation in a \$1 million Nigerian check scam. In this scam, a message in broken English pleaded for the financial help of the kind recipient. In all cases, the sender was a high-ranking official who had millions stashed in an inaccessible spot. If the recipient wired money for the official's escape from his ravaged country, he or she was offered a share of the money. The average loss to the victims of this scam was more than \$5000.

this program must have exactly one blank between each byte, and end the program with “zz”. The simulator uses two z’s to indicate the end of the program. Here is a screenshot of the Pep/9 machine-language program we wrote in the previous section:



Before a machine-language program can be executed, it must be loaded into memory. This is accomplished by a software tool called a *loader*. In the Pep/9 simulator, you load a program by selecting the Build > Load menu option. After loading the program into memory, it can be executed by selecting the Build > Execute menu option.

If all goes as planned, when you execute the program, the output will appear in the Input/Output window of the simulator. (Make sure the Terminal I/O tab is selected.)



When the simulator executes a program, it is carrying out the program commands one at a time just as a real machine would, following the fetch-execute cycle discussed in Chapter 5:

1. Fetch the instruction from the memory location specified by the Program Counter.
2. Decode the instruction and update the Program Counter.
3. Get the operand (if needed).
4. Execute the instruction.

The Program Counter, Instruction Register, and Accumulator (A register) are all displayed in the CPU window of the simulator, along with several other registers we haven’t discussed:

CPU

N 0 Z 0 V 0 C 0

Accumulator	0x0069	105
Index Register	0x0000	0
Stack Pointer	0xFB8F	64399
Program Counter	0x000D	13
Instruction Specifier	00000000	STOP
Operand Specifier		
(Operand)		

Trace Traps

In the next section, we'll look at an example that performs character input and output.

Another Machine-Language Example

Let's look at another example of a machine-language program in Pep/9. The following code reads two characters as input and prints them in reverse order.

Action	Binary Instruction	Hex Instruction
Read first character from input device into accumulator	1101 0001 1111 1100 0001 0101	D1 FC 15
Store character from accumulator to memory	1111 0001 0000 0000 0001 0011	F1 00 13
Read second character from input device into accumulator	1101 0001 1111 1100 0001 0101	D1 FC 15
Print second character to output device	1111 0001 1111 1100 0001 0110	F1 FC 16
Load first character from memory	1101 0001 0000 0000 0001 0011	D1 00 13
Print first character to output device	1111 0001 1111 1100 0001 0110	F1 FC 16
Stop	0000 0000	00

The first instruction is a load byte instruction that reads from memory location FC15, which is the input device, and stores the character in the accumulator. The next instruction does a store byte operation to temporarily store that character in memory at location 0013. The character could be put anywhere in memory as long as we don't overwrite a part of our program or the operating system. When loaded, our program resides in memory from byte 0000 to 0012, so location 0013 is the first unused byte after the program itself.

The third instruction is identical to the first, using a load byte operation to read the second character from the input device and store it in the accumulator. The fourth instruction prints that character to the output device using a store byte operation.

The fifth instruction loads the first character, which we had previously stored in memory at location 0013, back into the accumulator. The sixth instruction is identical to the fourth, printing that character. Then the program is stopped using the unary stop instruction.

Here is the Terminal I/O window when this program is run, showing the input the user types in (AB) and the output the program produces (BA):



6.4 Assembly Language

As we pointed out in Chapter 1, the first tools developed to help the programmer were assembly languages. **Assembly languages** assign mnemonic letter codes to each machine-language instruction. The programmer uses these mnemonics in place of binary or hex digits. Programming using mnemonics instead of directly in machine language makes the programmer more efficient and the process less error prone. After all, it's much easier to remember the mnemonic ADDA (to add a value to the A register) than it is the opcode 0110.

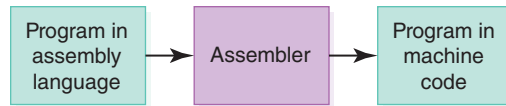
Ultimately, though, every program that is executed on a computer eventually must be in the form of the computer's machine language. So, we use a program called an **assembler** to read each of the instructions in

Assembly language

A low-level programming language in which a mnemonic represents each of the machine-language instructions for a particular computer

Assembler A program that translates an assembly-language program in machine code

mnemonic form and translate it into the machine-language equivalent, as shown here:



Because each type of computer has a different machine language, there are as many assembly languages and translators as there are types of CPUs.

Pep/9 Assembly Language

The goal of this section is not to make you an assembly-language programmer, but rather to have you appreciate the advantages of assembly-language programming over machine coding. With this goal in mind, we cover only a few of Pep/9's assembly-language features here. In Pep/9's assembly language, the operand is specified by "0x" and the hexadecimal value, then a comma followed by the addressing mode (the letter "i" for immediate or "d" for direct).

Mnemonic	Operand, Mode	Meaning
STOP		Stop execution
LDWA	0x008B, i	Load word 008B into accumulator
LDWA	0x008B, d	Load word located at 008B into accumulator
LDBA	0x008B, i	Load byte 008B into accumulator
LDBA	0x008B, d	Load byte located at 008B into accumulator
STWA	0x008B, d	Store word from accumulator to location 008B
STBA	0x008B, d	Store byte from accumulator to location 008B
ADDA	0x008B, i	Add 008B into accumulator
ADDA	0x008B, d	Add word located at 008B into accumulator
SUBA	0x008B, i	Subtract 008B from accumulator
SUBA	0x008B, d	Subtract word located at 008B from accumulator

There are two mnemonics used to load a value into the accumulator: LDWA to load a word and LDBA to load a byte. Both can be used with immediate addressing (i), which loads the value of the operand, or with direct addressing (d), which treats the operand as an address and loads the value found at that memory location.

There are two mnemonics for storing a value from the accumulator to a memory location, one for storing a word and one for storing a byte. As with the machine-language versions of these operations, they do not support immediate addressing mode.

The add and subtract operators support both immediate and direct addressing modes, and always operate on a full word.

In addition to regular instructions, assembly-language programming also allows **assembler directives**, which are instructions to the assembler itself. They are sometimes referred to as *pseudo-operations*. Here are some of Pep/9's assembler directives:

Assembler directives

Instructions to the translating program

Pseudo-op	Operand	Meaning
.END		Signals the end of the assembly-language program
.ASCII	"banana\x00"	Represents a string of ASCII characters
.WORD	0x008B	Reserves a word in memory and stores a value in it
.BLOCK	number of bytes	Reserves a particular number of bytes in memory

Let's look at an assembly-language version of the program we wrote that printed the word "Hi":

```

Source Code - Hi.pep
LDDB 0x0048,i ; Load 'H' into accumulator
STDB 0xFC16,d ; Store accumulator to output device
LDDB 0x0069,i ; Load 'i' into accumulator
STDB 0xFC16,d ; Store accumulator to output device
STOP ; Stop
.END

```

This code is written into the Source Code window of the Pep/9 simulator. The Pep/9 assembler ignores any characters after a semicolon. This allows the programmer to put in **comments**, which are text written for a human reader of the program, explaining what is happening. It's up to the programmer to decide which comments to include. Not every line needs a comment, but they are often helpful.

Comment

Explanatory text for the human reader

Of course, this source code in assembly language must be translated into machine code (or object code) before it can be executed. The Build > Assemble menu option runs the assembler on the source code. If there are no errors, the object code is displayed as well as an assembly code *listing*, which is a nicely formatted version of the program that includes the memory addresses and the object code:

Addr	Object code	Symbol	Mnemon	Operand	Comment
0000	D00048		LDBA	0x0048,i	;Load 'H' into accumulator
0003	F1FC16		STBA	0xFC16,d	;Store accumulator to output device
0006	D00069		LDBA	0x0069,i	;Load 'i' into accumulator
0009	F1FC16		STBA	0xFC16,d	;Store accumulator to output device
000C	00		STOP		;Stop
000D			.END		

For convenience, the Pep/9 simulator also provides the Build > Run Source menu option, which will assemble the source code into object code and then execute it automatically (instead of making you do those as separate steps). There is also a Run Source button you can press.

This program uses immediate addressing to load the characters, which is how we did it when we wrote this same program directly in machine language. Before moving on, compare it to the following version of this program, which uses direct addressing:

Addr	Object code	Symbol	Mnemon	Operand	Comment
0000	D1000D		LDBA	0x000D,d	; Load 'H' into accumulator
0003	F1FC16		STBA	0xFC16,d	; Store accumulator to output device
0006	D1000E		LDBA	0x000E,d	; Load 'i' into accumulator
0009	F1FC16		STBA	0xFC16,d	; Store accumulator to output device
000C	00		STOP		; Stop
000D	4869		.ASCII	"Hi"	; Characters to be printed
000F			.END		

In this version, the characters to be printed are stored in memory using the .ASCII assembler directive. As the listing shows, the load instructions access memory locations 000D and 000E, which correspond to the stored data.

Numeric Data, Branches, and Labels

You may have noticed that we never wrote a program directly in machine language that performed numeric calculations. That's because output for Pep/9 machine language is only defined for individual characters. If we had done arithmetic, we would have had to convert the input characters to numbers and vice versa to produce the output. It can be done, but that makes for a much longer machine-language program.

With the Pep/9 assembly language, additional instructions are available that perform input and output (I/O) with numbers and whole strings of characters. These instructions actually are implemented by the operating system.

In addition, upcoming examples will make use of **branch** instructions, which let the programmer decide which instruction to execute next. Here are some additional assembly-language instructions:

Branch An instruction that indicates which instruction to process next.

Mnemonic	Operand, Mode	Meaning
DECI	0x008B, d	Read a decimal number and store it into location 008B
DECO	0x008B, i	Write the decimal number 139 (8B in hex)
DECO	0x008B, d	Write the decimal number stored at location 008B
STRO	0x008B, d	Write the character string stored at location 008B
BR	0x001A	Branch to location 001A
BRLT	0x001A	Branch to location 001A if the accumulator is less than zero
BREQ	0x001A	Branch to location 001A if the accumulator is equal to zero
CPWA	0x008B	Compare the word stored at 008B with the accumulator

The **DECI** instruction stands for *Decimal Input*. It reads a decimal value (a number in base 10) from the input device and stores it into the location specified by the operand. The number can be made up of multiple digits—the instruction takes care of converting the typed characters into a number. Immediate addressing mode is not allowed for this instruction.

The **DECO** and **STRO** instructions cause data to be written to the output device. The **DECO** instruction outputs the specified value as a decimal number. Either immediate or direct addressing can be used. The **STRO** instruction is used for printing a full string of characters (perhaps a string stored in memory using the `.ASCII` directive).

The branch instruction **BR** is called an *unconditional branch* and causes the program counter (the register used to determine which instruction is fetched next) to be set to the memory address in the operand. A branch operation interrupts the normal linear flow of a program by “jumping” to another place in the program.

The **BRLT** and **BREQ** instructions cause the program to branch only if certain conditions are true, namely that the value in the accumulator is less than zero or equal to zero, respectively. Otherwise, the next instruction is executed as it normally would be.

Finally, the **CPWA** instruction compares the operand to the value that’s in the accumulator. More precisely, it subtracts the operand from the current value in the accumulator and stores the result in the accumulator. At that point, the accumulator will contain zero if the values are equal, or a negative value if the operand is greater than the current accumulator value. Then the **BRLT** or **BREQ** instructions can be used to make an appropriate decision.

Chapter 6: Low-Level Programming Languages and Pseudocode

Let's look at an example that reads two numbers from the user, adds them, and prints the result. To accomplish this, we'll need places in memory to store the two values and the sum. Although they could be stored after the program, memory used for data in an assembly-language program is often reserved before the program:

```

Source Code - AddNums.pep
sum:      BR      main      ; Branch around data
          .WORD  0x0000     ; Set up sum and initialize to zero
num1:     .BLOCK  2        ; Set up two byte block for num1
num2:     .BLOCK  2        ; Set up two byte block for num2

main:     LDWA   sum,d      ; Load zero into accumulator
          DECI  num1,d     ; Read and store num1
          ADDA  num1,d     ; Add num1 to accumulator
          DECI  num2,d     ; Read and store num2
          ADDA  num2,d     ; Add num2 to accumulator
          STWA  sum,d      ; Store accumulator into sum
          DECO  sum,d      ; Output sum
          STOP
          .END

```

Label A name given to a memory location, which can then be used as an operand.

This program makes use of **labels** on some of the assembly directives and instructions. Labels are put at the beginning of the line, followed by a colon. Once labeled, the data or instruction at that location can be referred to by its label instead of its specific memory address. This makes the program much easier to follow.

In this example, the first line of code is a branch instruction that jumps over the data to the first real line of the program, labeled `main`. The program statements execute from there until the `STOP` instruction is reached.

The data at the beginning of the program is made up of a word labeled `sum`, which is initialized to zero, and two blocks (each 2 bytes long) labeled `num1` and `num2` that will hold the two numbers to add.

The program reads the first number, storing it in `num1`, and then adds it to the accumulator. It then does the same for `num2`. The sum of the two numbers is now in the accumulator, which is stored back into the memory location labeled `sum`. Finally, the `sum` is written to the output device.

When the program is executed, the user types the two numbers in the Terminal window, and the program prints the `sum`:



```

Batch I/O Terminal I/O
Input/Output
35
18
53

```

The labels and their corresponding addresses are shown in a *symbol table* after the code listing:

Assembler Listing – AddNums.pepl					
Addr	Object code	Symbol	Mnemon	Operand	Comment
0000	120009		BR	main	; Branch around data
0003	0000	sum:	.WORD	0x0000	; Set up sum and initialize to zero
0005	0000	num1:	.BLOCK	2	; Set up two byte block for num1
0007	0000	num2:	.BLOCK	2	; Set up two byte block for num2
0009	C10003	main:	LDWA	sum,d	; Load zero into accumulator
000C	310005		DECI	num1,d	; Read and store num1
000F	610005		ADDA	num1,d	; Add num1 to accumulator
0012	310007		DECI	num2,d	; Read and store num2
0015	610007		ADDA	num2,d	; Add num2 to accumulator
0018	E10003		STWA	sum,d	; Store accumulator into sum
001B	390003		DECO	sum,d	; Output sum
001E	00		STOP		; Stop
001F			.END		

Symbol table			
Symbol	Value	Symbol	Value
main	0009	num1	0005
num2	0007	sum	0003

Here is a variation on the AddNums program, which prints an error message if the `sum` of the two numbers is negative:

Source Code – AddNums2.pep					
	BR	main			; Branch to main program
sum:	.WORD	0x0000			; Set up sum and initialize to zero
num1:	.BLOCK	2			; Set up a two byte block for num1
num2:	.BLOCK	2			; Set up a two byte block for num2
negMsg:	.ASCII	"Error\x00"			; Error message in case sum is negative
error:	STRO	negMsg,d			; Print the error message
	BR	finish			
main:	LDWA	sum,d			; Load zero into accumulator
	DECI	num1,d			; Read and store num1
	ADDA	num1,d			; Add num1 to accumulator
	DECI	num2,d			; Read and store num2
	ADDA	num2,d			; Add num2 to accumulator
	BRLT	error			; Branch to error if A < 0
	STWA	sum,d			; Store accumulator into sum
	DECO	sum,d			; Output sum
finish:	STOP				; Stop
	.END				

This version has another label for printing the error message. A `BRLT` instruction is used to branch to the error message only if the accumulator (the `SUM`) contains a negative number. After printing the error message, an unconditional branch is used to jump to the end of the program, labeled `finish`.

Here is a sample output when the two input values add to a negative number:



Who is Genevieve Bell?

Dr. Bell is an anthropologist at Intel, the world's largest producer of semiconductors. She is director of user experience research at Intel Labs, the company's research arm. She runs a group of some 100 social scientists and designers who travel the globe, observing how people use technology in their homes and in public.³

```

Batch I/O Terminal I/O
Input/Output
23
-24
Error

```

Loops in Assembly Language

What if we wanted to read and **sum** three values? 10 values? 50? Let's rewrite our AddNums program yet again to use a *loop*, which is a section of code the program executes multiple times based on some criteria:

```

Source Code - AddNums3.pep
      BR      main          ; Branch to main program
sum:   .WORD  0x0000        ; Set up sum and initialize to zero
counter: .WORD 0x0000      ; Set up the counter
num:   .BLOCK 2            ; Set up a two byte block for num
limit: .BLOCK 2            ; Set up a two byte block for limit
main:  DECI   limit,d       ; Read the number of values to add up
loop:  DECI   num,d         ; Read a number
      LDWA   sum,d         ; Load the current sum into the accumulator
      ADDA   num,d         ; Add the number to the sum
      STWA   sum,d         ; Store the sum
      LDWA   counter,d     ; Load the counter into the accumulator
      ADDA   1,i           ; Add one to the counter
      STWA   counter,d     ; Store the counter
      CPWA   limit,d       ; Compare counter and limit
      BREQ  finish        ; Branch to finish if counter has reached limit
      BR    loop          ; Otherwise, branch to loop to read another number
finish: DECO   sum,d        ; Output sum
      STOP                               ; Stop
      .END

```

This program first reads a number from the user that specifies how many values will contribute to the **sum**. It also uses a counter, which starts at 0. Then we enter the loop, which reads a value and adds it to the **sum**. Each time through the loop, we add 1 to the counter and check it to see if we have reached the limit using a **BREQ** instruction. If so, we break to the end of the program. If not, we go back to the top of the loop to process another value.

Here is a sample run that reads and sums four numbers: $35 + 25 + 10 + 20 = 90$.

```

Input/Output
4
35
25
10
20
90

```

6.5 Expressing Algorithms

In the previous sections, we have written programs to write out a greeting, read characters in and write them out in reverse order, add numbers together and print an error message if the sum is negative, and enter a value and read and sum that many numbers. We expressed the solution to each problem in paragraph form and then wrote the code. In computing, the plan for a solution is called an **algorithm**. As you saw, going from the problem in paragraph form to the code is not always a clear-cut process. **Pseudocode** is a language that allows us to express algorithms in a clearer form.

Algorithm A plan or outline of a solution; a logical sequence of steps that solve a problem

Pseudocode Functionality

Pseudocode is not a real computer language, but rather a shorthand-like language that people use to express actions. There are no special grammar rules for pseudocode, but to express actions we must be able to represent the following concepts.

Pseudocode A language designed to express algorithms

Variables

Names that appear in pseudocode algorithms refer to places in memory where values are stored. The name should reflect the role of the content in the algorithm. For example, the variable `sum` could be used to represent the summation of a set of other values.

Assignment

If we have variables, we must have a way to put a value into one. We use the statement

Set sum to 0

**What was the Music Genome Project?**

In 2002, Will Glaser, Jon Craft, and Tim Westergren founded the company Savage Beast Technologies and created the Music Genome Project. The project, which was created to capture “the essence of music at the most fundamental level,” uses hundreds of musical attributes or “genes” to describe scores, as well as an intricate mathematical formula to analyze them. The project has analyzed tens of thousands of diverse scores and artists for attributes such as melody, harmony and rhythm, instrumentation, orchestration, arrangement, and lyrics.

to store a value into the variable `sum`. Another way of expressing the same concept uses a back arrow (`<—`):

```
sum <— 1
```

When we want to access the value of the variable later, we just use the name. For example, we access the values in `sum` and `num` in the following statement:

```
Set sum to sum + num
```

or

```
sum <— sum + num
```

The value stored in `sum` is added to the value in `num` and the result is stored back in `sum`. Thus, when a variable is used on the right side of the `to` or `<—`, the value of the variable is accessed. When a variable is used following `Set` or on the left side of `<—`, a value is stored into the variable.

The value being stored into a variable can be a single value (as in 0) or an *expression* made up of variables and operators (as in `sum + num`).

Input/Output

Most computer programs simply process data of some sort, so we must be able to input data values from the outside world and output the result on the screen. We can use the word *write* for output and the word *read* for input.

```
Write “Enter the number of values to read and sum”
```

```
Read num
```

The characters between the double quotation marks are called *strings* and tell the user what to enter or to describe what is written. It doesn’t matter which exact words you use: *Display* or *Print* would be equivalent to *Write*; *Get* or *Input* would be synonyms for *Read*. Remember, pseudocode algorithms are written for a human to translate into some programming language at a later stage, so there are no set rules. However, being consistent within a project is a good idea—both for you as you are working and for the person following you, who may have to interpret what you have written.

The last two output statements demonstrate an important point:

```
Write “Err”
```

```
Write sum
```

The first writes the characters between the double quotation marks on the screen. The second writes the *contents* of the variable `sum` on the screen. The value in `sum` is not changed.

Selection

The selection construct allows a choice between performing an action or skipping it. Selection also allows a choice between two actions. The condition in parentheses determines which course of action to follow. For example, the following pseudocode segment prints the sum or an error message.

```
// Read and sum three numbers
IF (sum < 0)
    Print error message
ELSE
    Print sum
// Whatever comes next
```

We use indentation to group statements (only one in this case). Control goes back to the statement that is not indented. The `//` introduces a comment to the reader, which is not part of the algorithm.

This version of the selection construct is called the *if-then-else* version because the algorithm chooses between two actions. The *if-then* version is the case where an action is executed or skipped. If we wanted to print the sum in any event, we could show the algorithm this way.

```
// Read and sum three numbers
IF(sum < 0)
    Print error message
Print sum
// Whatever comes next
```

Repetition

The repetition construct allows instructions to be repeated. In the summing problem, for example, a counter is initialized, tested, and incremented. Pseudocode allows us to outline the algorithm so that the pattern becomes clear. Like the selection construct, the expression in parentheses beside the `WHILE` is a test. If the test is true, the indented code is executed. If the test is false, execution skips to the next non-indented statement.

```
Set limit to number of values to sum
WHILE (counter < limit)
    Read num
    Set sum to sum + num
    Set counter to counter + 1
// Rest of program
```

Boolean expression

An expression that, when evaluated, is either true or false

The expression in parentheses beside the WHILE and the IF is a **Boolean expression**, which evaluates to either true or false. In the IF, if the expression is true, the indented block is executed. If the expression is false, the indented block is skipped and the block below the ELSE is executed if it exists. In the WHILE, if the expression is true, the indented code is executed. If the expression is false, execution skips to the next non-indented statement. We are putting WHILE, IF, and ELSE in all capital letters because they are often used directly in various programming languages. They have special meanings in computing.

TABLE 6.1 summarizes the pseudocode elements we've covered.

TABLE**6.1 Pseudocode Elements**

Construct	What It Means	Example
Variables	Named places into which values are stored and from which values are retrieved.	sum, total, counter, name
Assignment	Storing a value into a variable.	Set number to 1 number ← 1
Input/output	Input: reading in a value, probably from the keyboard. Output: displaying the contents of a variable or a string, probably on the screen.	Read number Get number Write number Display number Write "Have a good day"
Repetition (iteration, looping)	Repeat one or more statements as long as a condition is true.	While (condition) // Execute indented statement(s)
Selection: <i>if-then</i>	If a condition is true, execute the indented statements; if a condition is not true, skip the indented statements.	IF (newBase = 10) Write "You are converting" Write "to the same base." // Rest of code
Selection: <i>if-then-else</i>	If a condition is true, execute the indented statements; if a condition is not true, execute the indented statements below ELSE.	IF (newBase = 10) Write "You are converting" Write "to the same base." ELSE Write "This base is not the" Write "same." // Rest of code

Here is the pseudocode algorithm for the program that read and summed two values and printed an error message if the total was negative:

```

Set sum to 0
Read num1
Set sum to sum + num1
Read num2
Set sum to sum + num2
If (sum < 0)
    Write "Error"
ELSE
    Write sum

```

Here is the pseudocode algorithm for the program that input the number of values to read, read them, and printed the sum:

```

Set counter to 0
Set sum to 0
Read limit
While (counter < limit)
    Read num
    Set sum to sum + num
    Set counter to counter + 1
Print sum

```

Note that expressing an idea in pseudocode might translate to many instructions in low-level languages like assembly language.

Following a Pseudocode Algorithm

In Chapter 2, we introduced an algorithm for converting from base 10 to other bases. We expressed this algorithm in pseudocode for a human to follow.

```

While (the quotient is not zero)
    Divide the decimal number by the new base
    Set the next digit to the left in the answer to the remainder
    Set the decimal number to the quotient

```

To refresh our memories, we apply this algorithm to convert decimal number 93 to octal. We divide 93 by 8 (the new base), giving a quotient of 11 and a remainder of 5. This is the first division, so 5 becomes the digit in the units position of the answer. The original decimal number (93) is replaced by the quotient, 11. The quotient is not 0, so we divide 11 by 8, giving a quotient of 1 and a remainder of 3. The digit 3 becomes the digit to

the left of 5, giving a temporary answer of 35. The current decimal number (11) is replaced by the quotient 1. The quotient is not 0, so we divide it by 8, giving a quotient of 0 and a remainder of 1. The digit 1 becomes the leftmost digit in the answer, giving a value of 135. The quotient is 0, so the process ends.

This paragraph again shows how challenging English descriptions can be to read! First let's summarize the calculations.

Division	Quotient	Remainder	Answer
93/8	11	5	5
11/8	1	3	35
1/8	0	1	135

Now let's start over again, giving names to the values that we need to keep: *decimalNumber*, *newBase*, *quotient*, *remainder*, and *answer*. We depict these items as named boxes in which we write a value. See [FIGURE 6.6\(a\)](#). We have put a question mark in boxes for which we do not know the contents.

In following an algorithm, we draw boxes for variables and fill in the values. The algorithm begins by asking if the value in *quotient* is 0. Let's assume it is not, but we'll come back to this point later. [FIGURE 6.6\(b\)](#) shows the results after the first time through the loop, dividing 93 by 8. The quotient is 11, so we repeat the process. [FIGURE 6.6\(c\)](#) displays the values after this repetition. The quotient is not 0, so we divide 1 by 8, giving the situation in [FIGURE 6.6\(d\)](#). Now the quotient is 0, so the process stops.

(a) Initial values	<i>decimalNumber</i>	<i>newBase</i>	<i>quotient</i>	<i>remainder</i>	<i>answer</i>
	93	8	?	?	?
(b) After first time through loop (93/8)	<i>decimalNumber</i>	<i>newBase</i>	<i>quotient</i>	<i>remainder</i>	<i>answer</i>
	11	8	11	5	5
(c) After second time through loop (11/8)	<i>decimalNumber</i>	<i>newBase</i>	<i>quotient</i>	<i>remainder</i>	<i>answer</i>
	1	8	1	3	35
(d) After third time through loop (1/8)	<i>decimalNumber</i>	<i>newBase</i>	<i>quotient</i>	<i>remainder</i>	<i>answer</i>
	0	8	0	1	135

FIGURE 6.6 Walk-through of a conversion algorithm

One of our boxes, *decimalNumber*, originally contained the initial data value for the problem, the number to be converted. In a computer algorithm, we must give instructions to someone at the keyboard to input this value (this is called a *prompt*). Box *newBase* did not change throughout the process, but it too must be input from the keyboard because the algorithm is to change a decimal number into some other base. So the new base—base 8 in this case—must be input to the problem.

When we went through this algorithm, we knew that *quotient* had not been calculated yet, so we could assume it was not 0. In an algorithm for a computer to follow, we must make sure that the quotient is not 0 by setting it to some nonzero value initially.

Here is the same algorithm rewritten in concrete steps from which a program could be written. *DIV* is an operator that returns the decimal quotient, and *REM* is an operator that returns the decimal remainder.

```
Write "Enter the new base"
Read newBase
Write "Enter the number to be converted"
Read decimalNumber
Set answer to 0
Set quotient to decimal number
While (quotient is not zero)
    Set quotient to decimalNumber DIV newBase
    Set remainder to decimalNumber REM newBase
    Make the remainder the next digit to the left in the answer
    Set decimalNumber to quotient
Write "The answer is ", answer
```

Writing a Pseudocode Algorithm

Here we will walk you through the algorithm development process on a small scale, pointing out strategies that we are using. In Chapter 7, we explore writing algorithms in more depth.

Let's read in pairs of positive numbers and print each pair in numeric order. If there is more than one pair of numbers, we must have a loop. Here is a first approximation of the algorithm:

```
While (not done)
    Write "Enter two values separated by a blank; press return"
    Read number1
    Read number2
    Print them in order
```

What is Pandora?

Pandora is a music streaming company that tailors the music it plays to each listener's preferences. Pandora uses the results of the Music Genome Project to make selections that the listener is likely to enjoy. In early 2018, 78 million people actively used Pandora, including 5.5 million paid subscribers. Do you listen to Pandora?^{4, 11}

Chapter 6: Low-Level Programming Languages and Pseudocode

How do we know when to stop? That is, how do we break down *not done* into a question? We can ask the user to tell you how many pairs are to be entered. Here is the second pass:

```
Write "How many pairs of values are to be entered?"
Read numberOfPairs
Set pairsRead to 0
While (pairsRead < numberOfPairs)
    Write "Enter two values separated by a blank; press return"
    Read number1
    Read number2
    Print them in order
```

How do we determine the order of the numbers? We compare the values using the conditional construct. If *number1* is less than *number2*, we print *number1* and then *number2*. Otherwise, we print *number2* and then *number1*. Before we complete the algorithm, have we forgotten anything? *numberRead* never changes! We must increment *numberRead*.

```
Write "How many pairs of values are to be entered?"
Read numberOfPairs
Set numberRead to 0
While (numberRead < numberOfPairs)
    Write "Enter two values separated by a blank; press return"
    Read number1
    Read number2
    If (number1 < number2)
        Print number1, " ", number2
    ELSE
        Print number2, " ", number1
    Set numberRead to numberRead + 1
```

In going through the process of writing this algorithm, we used two major strategies. We *asked questions* and we *deferred details*. Asking questions is a strategy with which most of us are familiar. Deferring details means giving a task a name and then filling in the details of how to accomplish that task at a later time. That is, we first wrote the algorithm using *more pairs and print them in order*; then we filled in the details of how to accomplish these tasks at a later time.

An algorithm is not complete until it has been tested. We can use the same technique that we relied on to simulate the base conversion algorithm: We can choose data values and work through the code with paper and pencil. This algorithm has four variables that we must trace:

`numberOfPairs`, `numberRead`, `number1`, and `number2`. Let's assume the user enters the following data when prompted:

```
3
10 20
20 10
10 10
```

FIGURE 6.7(a) shows the values of the variables at the beginning of the loop. `numberRead` is less than `numberOfPairs`, so the loop is entered. The prompt is issued and the two numbers are read. `number1` is 10 and `number2` is 20, so the *if* statement takes the *then* branch. `number1` is printed, followed by `number2`. `numberRead` is incremented. **FIGURE 6.7(b)** shows the values at the end of the first repetition. `numberRead` is still less than `numberOfPairs`, so the code is repeated. The numbers are prompted for and read. `number1` is 20 and `number2` is 10, so the *else* branch is taken. `number2` is printed, followed by `number1`. `numberRead` is incremented, resulting in the state of the variables at the end of the second iteration as shown in **FIGURE 6.7(c)**.

`numberRead` is less than `numberOfPairs`, so the code is repeated. The inputs are prompted for and read, making `number1` 10 and `number2` 10. Because `number1` is not less than `number2`, the *else* branch is taken. `number2` is printed, followed by `number1`. Because the values are the same, it doesn't matter in which order they are printed. `numberRead` is incremented. `numberRead` is now not less than `numberOfPairs`, so the code is not repeated.

(a) At the beginning	<code>numberOfPairs</code>	<code>numberRead</code>	<code>number1</code>	<code>number2</code>
	3	0	?	?
(b) At the end of the first iteration	<code>numberOfPairs</code>	<code>numberRead</code>	<code>number1</code>	<code>number2</code>
	3	1	10	20
(c) At the end of the second iteration	<code>numberOfPairs</code>	<code>numberRead</code>	<code>number1</code>	<code>number2</code>
	3	2	20	10
(d) At the end of the first iteration	<code>numberOfPairs</code>	<code>numberRead</code>	<code>number1</code>	<code>number2</code>
	3	3	10	10

FIGURE 6.7 Walk-through of pairs algorithm

Desk checking

Tracing the execution of a design on paper

In this process, which is called **desk checking**, we sit at a desk with a pencil and paper and work through the design. It is useful to take actual data values and trace what happens to them as we reason about the design. This technique is simple but amazingly effective.

Translating a Pseudocode Algorithm

In Chapter 1, we described the layers of languages that were produced over time. In this chapter, we began with machine language (the lowest layer) and moved up one step to assembly language. How we translate a pseudocode algorithm depends on the language into which we are translating the algorithm. Here, where we are limited by the limits of an assembly language, one pseudocode statement often requires several Pep/9 statements.

We have written our algorithm as an interactive program. That is, the program asks the user to do something. In this case, the first instruction was to write a request to the user to enter the number of pairs. This is exceptionally easy in a high-level language, but more complicated in Pep/9. First we have to set up the message using a `.ASCII` pseudo-operation and then set up the code to have it written out. Let's shorten the message to "Enter number." `STRO` is used to print the message.

```

msg1:  .ASCII  "Enter number\x00"  ; First message
...
      STRO    msg1                  ; Write message

```

Reading the number of pairs can be done with one Pep/9 instruction. Setting the number read to 0 can be done in one pseudo-operation. We set up the loop by loading the number read into the A register (the accumulator) and comparing it with the number to be read. Once within the loop, a second instruction is given to the user. Let's put these pieces together.

```

      BR      main
msg1:  .ASCII  "Enter number\x00"  ;
msg2:  .ASCII  "Enter pairs\x00"   ;
numRead: .WORD  0x00               ;
numPairs: .BLOCK 2                 ;
number1: .BLOCK 2                 ;
number2: .BLOCK 2                 ;
main:  STRO    msg1,d              ;
      DECI    numPairs,d          ;
begin: STRO    msg2,d              ;
      ...
      BR      begin                ;

```

?

Certification and licensing

Certification is the process by which nongovernmental organizations grant recognition to an individual who has met predetermined qualifications specified by the organization. Licensing is a government's grant of legal authority, which is not voluntary. Almost anyone who provides a service to the public is required to be licensed or certified; computer professionals do not.

© Artur Debat/Getty Images; © Alan Dyer/Stocktrek Images/Getty Images

Konrad Zuse

Konrad Zuse was born in Berlin on June 22, 1910.⁵ He attended the Humanistisches Gymnasium and studied civil engineering at the Technische Hochschule of Berlin-Charlottenburg. After graduation he worked briefly for the Ford Motor Company and then went to work for Henschel & Son, a maker of transportation equipment.⁶

In 1935 in his parent's flat, Zuse started experimenting in the construction of a machine to take over the boring calculations required in engineering. His first attempt was the Z1, which had a floating-point binary mechanical calculator. Zuse's 1936 patent application anticipated the von Neumann architecture by nine years, with program and data modifiable in storage.⁷ Zuse briefly served in the German infantry but persuaded the army to let him return to building computers.⁸

Between 1936 and 1945, Zuse continued to improve on the Z1 with his Z2, Z3, and Z4 machines. The Z1, along with its original blueprints, were destroyed in a British air raid in World War II. Because of World War II, Zuse worked in near-total isolation, knowing nothing of the work of Turing, Atanasoff, or Eckert and Mauchly.

In 1946, Zuse founded one of the earliest computer companies, and in 1949, he founded a second computer company. Zuse KG produced

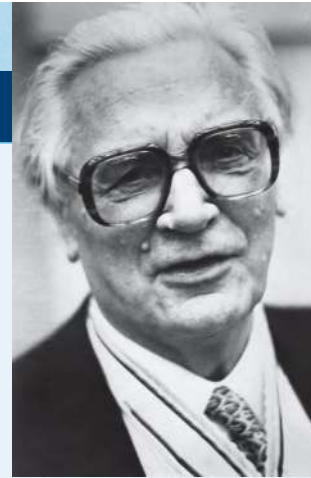
the Z4, the world's first commercial computer, and delivered it to ETH Zurich. Zuse KG built a total of 251 computers and was eventually sold to Siemens.

While working on the Z4, Zuse concluded that programming in machine code was too complicated.

As the war progressed, he had to flee Berlin for the countryside, where there was no hardware to work on. There he designed the first high-level programming language, *Plankalkul* (Plan Calculus). Although it was never implemented, this was the first attempt at a general programming language.

In the late 1980s, with funding from Siemens and five other computer companies, Zuse built a working reconstruction of the Z1, which is now displayed at the Deutsches Technikmuseum in Berlin.

Konrad Zuse married Gisela Brandes in January 1945 in a very formal ceremony. The couple had five children. He died on December 18, 1995, in Germany. The 100th anniversary of his birth was celebrated with exhibitions, lectures, and workshops to remember the life and legacy of this computing pioneer.



© Karl Staedele/dpa/Corbis

Now we must translate the loop body, which requires writing a message, reading two values, and comparing them. The first two tasks require only one `Pep/9` statement each, but the *if-then-else* statement will take more work. To complete the program, you would write the code to print

Test plan A document that specifies how a program is to be tested

Code coverage (clear-box) testing

Testing a program or subprogram based on covering all the statements in the code

Data coverage (black-box) testing

Testing a program or subprogram based on the possible input values, treating the code as a black box

Test plan implementation

Using the test cases specified in a test plan to verify that a program outputs the predicted results

each of the two statements, give names to the first instruction in each code block, and then determine which block should be executed. We leave these last steps as an exercise.

6.6 Testing

We briefly tested our programs by executing them to see if they produced the output we expected. However, there is far more to testing than just running the program once.

How you test and what you test depend on what the program does, how it will be used, and how essential it is that it be correct.

Almost all programs have errors. They are a fact of life. Programmers create errors during the act of creating a program, and then have to find and fix them. Interestingly, whether a program has errors or not may depend on who's doing the evaluation. The end user, who best understands how the program will be used, has a different perspective than the program designer, who is coming at the problem from another viewpoint. A program may "work," but if it doesn't solve the problem the end user needs solved, then it's not correct.

For now, we will focus on straightforward correctness as defined by the stated goals of the program.

How do we test a specific program to determine its correctness? We design and implement a **test plan**. A test plan is a document that specifies how many times and with which data a program must be run to thoroughly test the program. Each set of input data values is called a *test case*. The test plan should list the reason for choosing the data, the data values, and the expected output from each case.

The test cases should be chosen carefully. Several approaches to testing can be used to guide this process. **Code coverage** is an approach that designs test cases to ensure that each statement in the program is executed. Because the tests are based on the code of the program, this approach is also called **clear-box testing**. Another approach, **data coverage**, calls for designing test cases to ensure that the limits of the allowable data are covered. Because this approach is based solely on input data and not the code, it is also called **black-box testing**. Often testing entails a combination of these two approaches.

Test plan implementation involves running each of the test cases described in the test plan and recording the results. If the results are not as expected, you must go back to your design and find and correct the error(s). The process stops when each of the test cases gives the expected results. Note that an implemented test plan gives us a measure of

confidence that the program is correct; however, all we know for sure is that our program works correctly on the test cases. Therefore, the quality of the test cases is extremely important.

In the case of the program that reads in two values and sums them, a clear-box test would include just two data values. There are no conditional statements in this program to test with alternate data. However, a clear-box test would not be sufficient here, because we need to try both negative and positive data values. The numbers that are being read in are stored in one word. The problem does not limit values to $\pm 2^{15} - 1$, but our implementation does. We should also try values at the limits of the size of the allowed input in the test plan, but because they are being summed, we need to be sure the sum does not exceed $\pm 2^{15} - 1$.

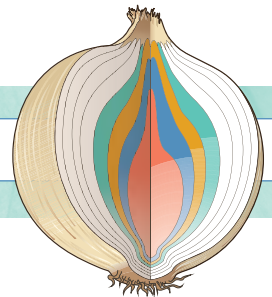
Reason for Test Case	Input Values	Expected Output	Observed Output
Assumption: Input values are no greater than 2^{15} or less than -2^{15} .			
Input two positive numbers	4, 6	10	10
Input two negative numbers	-4, -6	-10	-10
Input mixed numbers	4, -6	-2	-2
	-4, 6	2	2
Input large numbers	32767, -1	32766	32766

To implement this test plan, we ran the program five times, once for each test case. The results were then written in the “Observed Output” column. They were what we had predicted, which increases our confidence that the program works as planned. If any of the observed output had been different than expected, we would then explore the problem the test case uncovered.

© Artur Debat/Getty Images; © Alan Dyer/Stocktrek Images/Getty Images

SUMMARY

A computer can store, retrieve, and process data. A user can enter data into the machine, and the machine can display data so that the user can see it. At the lowest level of abstraction, instructions to the machine directly relate to these five operations.



A computer's machine language is the set of instructions that the machine's hardware is built to recognize and execute. Machine-language programs are written by entering a series of these instructions in their binary form. The Pep/9 is a virtual computer with an A register (the accumulator) and two-part instructions. One part of the instruction tells which action the instruction performs, and the other part specifies where the data to be used (if any) can be found. Programs written using the Pep/9 instruction set can be run using a simulator—a program that behaves like the Pep/9 computer.

The Pep/9 assembly language is a language that allows the user to enter mnemonic codes for each instruction rather than binary numbers. Programs written in assembly language are translated into their machine-language equivalents, which are then executed using the Pep/9 simulator.

Pseudocode is a shorthand-like language that people use to express algorithms. It allows the user to name variables (places to put values), input values into variables, and print out the values stored in variables. Pseudocode also allows us to describe algorithms that repeat actions and choose between alternative actions. Asking questions and deferring details are two problem-solving strategies used in algorithm design.

Programs, like algorithms, must be tested. Code coverage testing involves determining the input to the program by looking carefully at the program's code. Data coverage testing involves determining the input by considering all possible input values.



ETHICAL ISSUES

Software Piracy

Have you ever upgraded your operating system by borrowing the latest software from a friend? Or, when you spent only \$50 to purchase sophisticated software, did you ignore your suspicion that this “steal” was too good to be true? The casual attitude of many toward duplicating, downloading, and reselling software has made software piracy a critical issue for the computer industry. A 2018 report by the Business Software Alliance notes that while the rate of pirated software is down slightly from previous years, it continues to have potentially devastating effects on companies due to malware in unlicensed software, costing companies nearly \$359 billion a year.⁹

Software piracy is defined as the unlawful reproduction of copyrighted software or a violation of the terms stated in the software’s license. A software license is a document that outlines the terms by which the user may use the software purchased. When you lend software to a friend or download software onto multiple computers without having a license that permits this, you are failing to adhere to the license agreement and are, in fact, breaking the law.

Why is software copyrighted? Unlike an idea or written work, software has

functionality. This unique quality distinguishes software from other forms of intellectual property and complicates its need for copyrighting. While a number of programs have open-source code, such as the Linux operating system, companies such as Microsoft® have chosen to protect their code. Copyrighting software is the only way to protect your code.

Who is involved in software piracy? In 2015, 70% of the software installed in China was unlicensed. In Indonesia, it was 84%. In Russia, 64%. The rate in the United States was only 17%, yet the value of that software was higher than all other countries (\$9.1 billion).¹⁰

Respecting the copyrights of software (if it is not open code) is important from several perspectives. According to John Gantz, chief research officer at IDC, “Lowering software piracy by just 10 percentage points during the next four years would create nearly 500,000 new jobs and pump \$140 billion into ailing economies.”¹¹

Using pirated software also puts users at risk by potentially exposing them to software viruses. The person who freely “borrows” software from a friend is actually stealing, and this action can have significant ramifications.

KEY TERMS

Algorithm	Data coverage (black-box) testing
Assembler	Label
Assembler directives	Loader
Assembly language	Machine language
Boolean expression	Pseudocode
Branch	Test plan
Code coverage (clear-box) testing	Test plan implementation
Comment	Virtual computer (machine)
Desk checking	

EXERCISES

For Exercises 1–15, mark the answers true or false as follows:

- A. True
 - B. False
1. Arithmetic can be performed in the instruction register.
 2. Arithmetic can be performed in the A register.
 3. Arithmetic can be performed in the accumulator.
 4. `LDBA 0x008B,i` loads the byte 008B into register A.
 5. `ADDA 0x008B,i` adds the contents of 008B to the A register.
 6. The program counter and the instruction register are two names for the same place.
 7. The A register and the accumulator are two names for the same place.
 8. The instruction register is 3 bytes long.
 9. The program counter is 3 bytes long.
 10. The branch instruction, BR, branches to the location specified in the operand specifier.
 11. The instruction specifier is 1 byte long.
 12. If the data to be loaded into the accumulator is stored in the operand, the instruction specifier ends with 000.
 13. If the data in the accumulator is to be stored in the place named in the operand, the instruction specifier ends with 000.
 14. All Pep/9 instructions use 3 bytes.
 15. At least one branching instruction is required in a loop.
- Given the following state of memory (in hexadecimal), complete Exercises 16–20 by matching the problem to the solution shown.
- | | |
|------|----|
| 0001 | A2 |
| 0002 | 11 |
| 0003 | 00 |
| 0004 | FF |
- a. A2 11
 - b. A2 12
 - c. 00 02

EXERCISES (CONTINUED)

- d. 11 00
e. 00 FF
16. What are the contents of the A register after the execution of this instruction?
C1 00 01
17. What are the contents of the A register after the execution of this instruction?
C1 00 02
18. What are the contents of the A register after the execution of the following two instructions?
C0 00 01
60 00 01
19. What are the contents of the A register after the execution of the following two instructions?
C1 00 01
60 00 01
20. What are the contents of location 0001 after the execution of the following two instructions?
C1 00 03
E0 00 01
- Exercises 21–60 are programs or short-answer questions.
21. What does it mean when we say that a computer is a *programmable* device?
22. List five operations that any machine language must include.
23. How many low-level tasks can each machine-language instruction perform?
24. What is a virtual machine? Discuss this definition in terms of the Pep/9 computer.
25. How many bits are used to represent an instruction in Pep/9?
26. Describe the features of the Pep/9 CPU that we covered in this chapter.
27. Where is the data (operand) if the address mode specifier is
a. 000?
b. 001?
28. We discussed two mode specifiers. How many are there?
29. Distinguish between the IR (instruction register) and the PC (program counter).
30. How many bits are required to address the Pep/9 memory?
31. How many more cells could be added to memory without having to change the instruction format? Justify your answer.
32. Some Pep/9 instructions are unary, taking only 1 byte. Other instructions require 3 bytes. Given the instructions that we have covered in this chapter, would it be useful to define instructions that require only 2 bytes?
33. What is the result of executing the following instructions?
0001 D0 00 48
0004 F1 FC 16
34. What is the result of executing the following instructions?
0001 D0 00 07
0004 70 00 02
35. Write a program in Pep/9 machine code to output the word “go”.
36. Write a program in Pep/9 assembly language to output the word “go”.
37. Write a program in Pep/9 machine code to output the word “home”.

EXERCISES (CONTINUED)

38. Write a program in Pep/9 assembly language to output the word “home”.
39. Explain how input and output work in Pep/9.
40. Distinguish between the Pep/9 menu options *Assemble*, *Load*, and *Execute (run)*.
41. The following program seems to run, but does strange things with certain input values. Can you find the bug?
- ```

BR main
sum: .WORD 0x0000
num1: .BLOCK 1
num2: .BLOCK 1
num3: .BLOCK 1
main: LDWA sum,d
 DECI num1,d
 DECI num2,d
 DECI num3,d
 ADDA num3,d
 ADDA num2,d
 ADDA num1,d
 STWA sum,d
 DECO sum,d
 STOP
 .END

```
42. Correct the code in Exercise 41.
43. What is the purpose of the `.ASCII` pseudo-operation?
44. Write a pseudocode algorithm that reads in three values and writes out the result of subtracting the second value from the sum of the first and third values.
45. Implement the algorithm in Exercise 44 as Pep/9 assembly-language program.
46. Write a test plan for the program in Exercise 45.
47. Design with pseudocode, then implement, an assembly language program that uses a loop to read four values and print their sum.
48. Is the test plan for a machine-language program valid for the same solution written in assembly language? Explain your answer.
49. Distinguish between the pseudo-operations `.BLOCK` and `.WORD`.
50. Distinguish between assembly-language pseudo-operations and mnemonic instructions.
51. Distinguish between test plans based on code coverage and data coverage.
52. Which button on the Pep/9 console must be clicked for keyboard input?
53. Write the Pep/9 assembly-language statement for the following instructions:
- Branch to location Branch1 if the accumulator is zero.
  - Branch to location Branch1 if the accumulator is negative.
  - Branch to location Branch1 if the accumulator is negative and to Branch2 if the accumulator is not negative.
54. Write a pseudocode algorithm to read in a name and write a “Good morning” message.
55. Write a pseudocode algorithm to get three integers from the user and print them in numeric order.
56. Enclose the design in Exercise 55 within a loop that reads in the three

**EXERCISES (CONTINUED)**

- values until the user enters the first value of the trio as negative.
57. Rewrite the algorithm in Exercise 56 so that the user has to enter only one negative value to stop (that is, the second and third values are not entered).
  58. Distinguish between pseudocode and pseudo-operations.
  59. What are the constructs that pseudocode must be able to express?
  60. Distinguish between the looping construct and the selection construct.

**THOUGHT QUESTIONS**

1. Would you like to do assembly-language programming? Can you think of any personality types that would be well suited for such detail-oriented work?
2. The translation process has been demonstrated by showing the machine-language program that is the result of the assembly-language program. Look carefully at the solution in Exercise 45. Think about the steps that the assembler program must execute. Do you think that the translation can be made by looking at each assembly-language instruction once, or must each one be examined twice? Convince a friend that you are right.
3. If a person has two computers of the same kind, is it ethical to buy one copy of a software package and install it on both machines? What are the arguments on the yes side? What are the arguments on the no side?
4. Has anyone borrowed software from you? Do you think he or she copied it?

## Laying the Groundwork

- 1 The Big Picture

## The Information Layer

- 2 Binary Values and Number Systems
- 3 Data Representation

## The Hardware Layer

- 4 Gates and Circuits
- 5 Computing Components

## The Programming Layer

- 6 Low-Level Programming Languages and Pseudocode
- 7 Problem Solving and Algorithms
- 8 Abstract Data Types and Subprograms
- 9 Object-Oriented Design and High-Level Programming Languages

## The Operating Systems Layer

- 10 Operating Systems
- 11 File Systems and Directories

## The Applications Layer

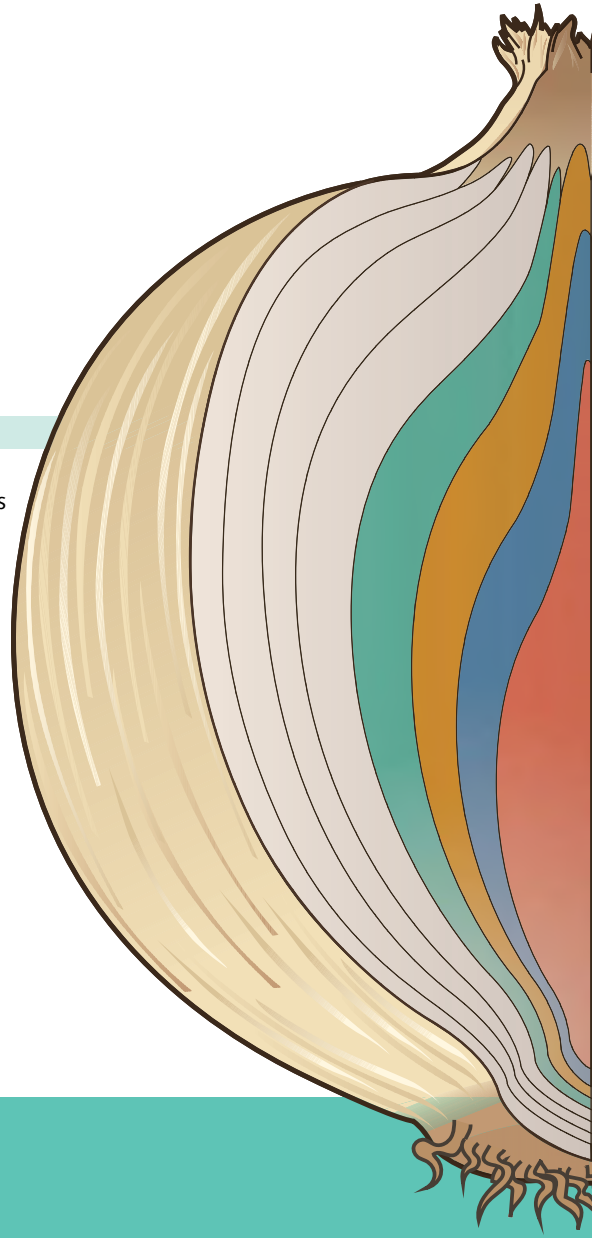
- 12 Information Systems
- 13 Artificial Intelligence
- 14 Simulation, Graphics, Gaming, and Other Applications

## The Communications Layer

- 15 Networks
- 16 The World Wide Web
- 17 Computer Security

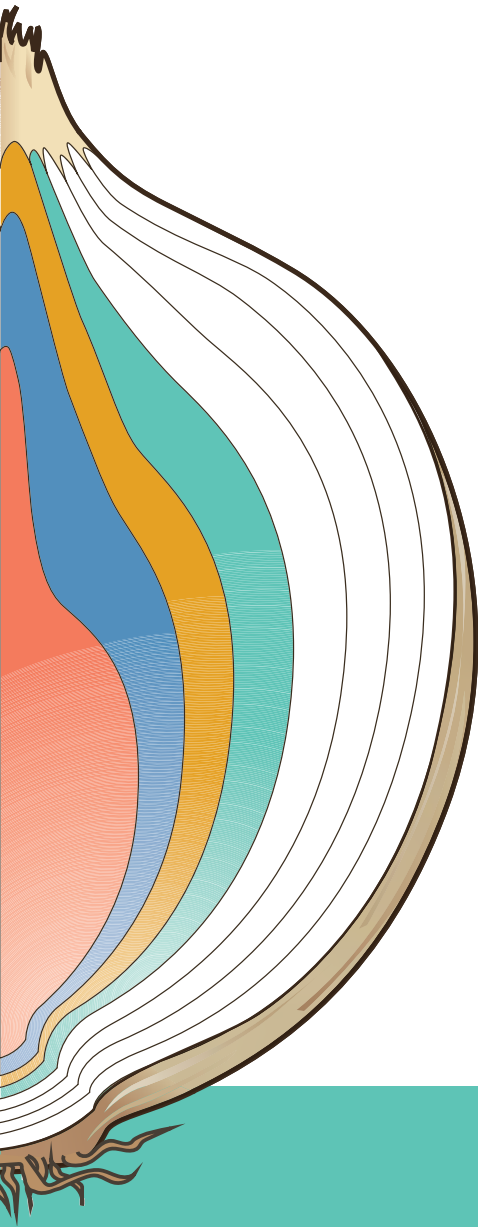
## In Conclusion

- 18 Limitations of Computing



# THE PROGRAMMING LAYER





## 7

# PROBLEM SOLVING AND ALGORITHMS

In Chapter 6, we looked at machine code, which uses binary numbers to represent operations, and assembly language, which uses mnemonics to represent operations. Assembly languages are a step in the right direction, but the programmer still must think in terms of individual machine instructions. We also introduced pseudocode, an artificial language designed for expressing algorithms. We begin this chapter with a brief discussion of problem solving in general.

Computer science is sometimes defined as “the study of algorithms and their efficient implementation in a computer.” The focus of this chapter is on algorithms: their role in problem solving, strategies for developing them, techniques for following and testing them. We choose classic searching and sorting algorithms as the context for the discussion on algorithms.

Because algorithms operate on data, we examine ways to structure data so that it can be more efficiently processed.

## GOALS

After studying this chapter, you should be able to:

- describe the computer problem-solving process and relate it to Polya’s How to Solve It list.
- distinguish between a simple type and a composite type.
- describe three composite data-structuring mechanisms.
- recognize a recursive problem and write a recursive algorithm to solve it.
- distinguish between an unsorted array and a sorted array.
- distinguish between a selection sort and an insertion sort.
- describe the Quicksort algorithm.
- apply the selection sort, the bubble sort, insertion sort, and Quicksort to an array of items by hand.
- apply the binary search algorithm.
- demonstrate your understanding of the algorithms in this chapter by hand-simulating them with a sequence of items.

## 7.1 How to Solve Problems

In 1945, George Polya wrote a little book entitled *How to Solve It: A New Aspect of Mathematical Method*.<sup>1</sup> Although this book was written more than 60 years ago, when computers were still experimental, it remains the classic description of the problem-solving process. The process is summarized in [FIGURE 7.1](#).

**HOW TO SOLVE IT**

**UNDERSTANDING THE PROBLEM**

**First.** *What is the unknown? What are the data? What is the condition?*  
 You have to *understand* the problem.  
 Is it possible to satisfy the condition? Is the condition sufficient to determine the unknown? Or is it insufficient? Or redundant? Or contradictory?  
 Draw a figure. Introduce suitable notation.  
 Separate the various parts of the condition. Can you write them down?

**DEVISING A PLAN**

**Second.** Have you seen it before? Or have you seen the same problem in a slightly different form?  
 Find the connection between the data and the unknown. You may be obliged to consider auxiliary problems if an immediate connection cannot be found. You should obtain eventually a *plan* of the solution.  
*Do you know a related problem?* Do you know a theorem that could be useful?  
*Look at the unknown!* And try to think of a familiar problem having the same or a similar unknown.  
*Here is a problem related to yours and solved before. Could you use it?* Could you use its result? Could you use its method? Should you introduce some auxiliary element in order to make its use possible? Could you restate the problem? Could you restate it still differently? Go back to definitions.  
 If you cannot solve the proposed problem, try to solve first some related problem. Could you imagine a more accessible related problem? A more general problem? A more special problem? An analogous problem? Could you solve a part of the problem? Keep only a part of the condition, drop the other part; how far is the unknown then determined; how can it vary? Could you derive something useful from the data? Could you think of other data appropriate to determine the unknown? Could you change the unknown or the data, or both if necessary, so that the new unknown and the new data are nearer to each other? Did you use all the data? Did you use the whole condition? Have you taken into account all essential notions involved in the problem?

**CARRYING OUT THE PLAN**

**Third.** Carrying out your plan of the solution, *check each step*. Can you see clearly that the step is correct? Can you prove that it is correct?  
 Carry out your plan.

**LOOKING BACK**

**Fourth.** Can you *check the result*? Can you check the argument? Can you derive the result differently? Can you see it at a glance? Can you use the result, or the method, for some other problem?  
 Examine the solution obtained.

**FIGURE 7.1** Polya's How to Solve It list

What has made Polya's book a classic is that his How to Solve It list is quite general. Although it was written in the context of solving mathematical problems, we can replace the word *unknown* with *problem*, *data* with *information*, and *theorem* with *solution*, and the list becomes applicable to all types of problems. Of course, it is the second step—finding the connection between the information and the solution—that lies at the heart of problem solving. Let's look at several strategies suggested by Polya's list.

## Ask Questions

If you are given a problem or task verbally, you typically ask questions until what you are to do is clear. You ask *when*, *why*, and *where* until your task is completely specified. If your instructions are written, you might put question marks in the margin; underline a word, a group of words, or a sentence; or in some other way indicate the parts of the task that are not clear. Perhaps your questions might be answered in a later paragraph, or you might have to discuss them with the person giving you the task. If the task is one that you set for yourself, this sort of questioning might not be verbal, but instead would take place on the subconscious level.

Some typical questions you should be asking are as follows:

- What do I know about the problem?
- What does the solution look like?
- What sort of special cases exist?
- How will I recognize that I have found the solution?

## Look for Familiar Things

As the saying goes, don't reinvent the wheel. If a solution exists, use it. If you've solved the same or a similar problem before, repeat the successful solution. We usually don't consciously think, "I have seen this before, and I know what to do"—we just do it. Humans are good at recognizing similar situations. We don't have to learn how to go to the store to buy milk, then to buy eggs, then to buy candy. We know that going to the store is always the same and only what we buy is different.

Recognizing familiar situations is particularly useful in computing. In computing, you see certain problems again and again in different guises. A good programmer sees a task, or perhaps part of a task (a subtask), that has been solved before and plugs in the solution. For example, finding the daily high and low temperatures in a list of temperatures is exactly the same problem as finding the highest and lowest grades in a list of test scores. You want the largest and smallest values in a set of numbers.

## Divide and Conquer

We constantly break up a large problem into smaller units that we can handle. The task of cleaning the house or apartment, for example, may seem overwhelming. By contrast, the individual tasks of cleaning the living room, the dining room, the kitchen, the bedrooms, and the bathroom seem more manageable. This principle is especially relevant to computing: We break up a large problem into smaller pieces that we can solve individually.

This approach applies the concept of abstraction that we discussed in Chapter 1—cleaning the house is a large, abstract problem made up of the subtasks defined by cleaning the individual rooms. Cleaning a room can also be thought of as an abstraction of the details of straightening the dresser, making the bed, vacuuming the floor, and so on. Tasks are divided into subtasks, which can be divided further into sub-subtasks and so forth. The divide-and-conquer approach can be applied over and over again until each subtask is manageable.

We applied two of these strategies in the last chapter when we asked questions and deferred details in designing the algorithm to read in two numbers and output them in order.

## Algorithms

The last sentence in the second step in Polya's list says that you should eventually obtain a plan of the solution. In computing, this plan is called an **algorithm**. We have used the term many times; here we define it in computing terms. Formally, an algorithm is a set of instructions for solving a problem or subproblem in a finite amount of time using a finite amount of data. Implicit in this definition is the understanding that the instructions are unambiguous.

In computing, we must make certain conditions explicit that are implicit in human solutions. For example, in everyday life we would not consider a solution that takes forever to be much of a solution. We would also reject a solution that requires us to process more information than we are capable of processing. These constraints must be explicit in a computer solution, so the definition of an algorithm includes them.

The third step in Polya's list is to carry out the plan—that is, to test the solution to see if it solves the problem. The fourth step is to examine the solution for future applicability.

### Algorithm

Unambiguous instructions for solving a problem or subproblem in a finite amount of time using a finite amount of data

© Artur Debat/Getty Images; © Alan Dyer/Stocktrek Images/Getty Images

## George Polya

George Polya was born in Budapest on December 13, 1887. Although he eventually became a world-famous mathematician, he did not show an early interest in mathematics. Polya's lack of interest might be explained by his memory of three high school mathematics teachers: "two were despicable and one was good."

In 1905, Polya entered the University of Budapest, where he studied law at the insistence of his mother. After one very boring semester, he decided to study languages and literature. He earned a teaching certificate in Latin and Hungarian—and never used it. He became interested in philosophy and took courses in math and physics as part of his philosophy studies. He settled on mathematics, commenting that "I am too good for philosophy and not good enough for physics. Mathematics is in between." He received his PhD in mathematics in 1912, which launched his career.

Polya did research and taught at the University of Göttingen, the University of Paris, and the Swiss Federation of Technology in Zurich. While in Zurich he interacted with John von Neumann, about whom he said, "Johnny was the only student I was ever afraid of. If, in the course of a lecture, I stated an unsolved problem, the chances were he'd come to me as soon as the lecture was over, with the complete solution in a few scribbles on a slip of paper."

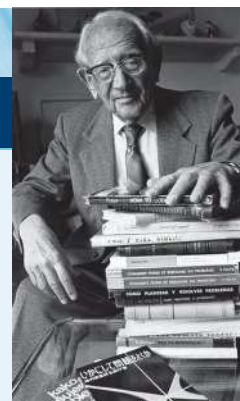
Like many Europeans of that era, Polya moved to the United States in 1940 because of the political situation in Germany. After teaching at Brown University for two years, he moved to Palo Alto, California, to teach at

Stanford University, where he remained for the rest of his career.

Polya's research and publications encompassed many areas of mathematics, including number theory, combinatorics, astronomy, probability, integral functions, and boundary value problems for partial differential equations. The George Polya Prize is given in his honor for notable applications of combinatorial theory.

Yet, for all George Polya's contributions to mathematics, it is his contribution to mathematics education of which he was the most proud and for which he will be the most remembered. His book *How to Solve It*, published in 1945, sold more than 1 million copies and was translated into 17 languages. In this book, Polya outlines a problem-solving strategy designed for mathematical problems. The generality of the strategy makes it applicable to all problem solving, however. Polya's strategy is the basis of the computer problem-solving strategy outlined in this text. *Mathematics and Plausible Reasoning*, published in 1954, was another book dedicated to mathematics education. Polya not only wrote about mathematics education, but also took an active interest in the teaching of mathematics. He was a regular visitor to the schools in the Bay Area and visited most of the colleges in the western states. The Math Center at the University of Idaho is named for him.

On September 7, 1985, George Polya died in Palo Alto at the age of 97.



© AP Photos

## Computer Problem-Solving Process

The computer problem-solving process includes four phases: the *analysis and specification phase*, the *algorithm development phase*, the *implementation phase*, and the *maintenance phase*. See [FIGURE 7.2](#). The output from the first phase is a clearly written problem statement. The output from the algorithm development phase is a plan for a general solution to the problem specified in the first phase. The output from the third phase is a working computer program that implements the algorithm—that is, a specific solution to the problem. There is no output from the fourth phase, unless errors are detected or changes need to be made. If so, these errors or changes are sent back to the first, second, or third phase, whichever is appropriate.

[FIGURE 7.3](#) shows how these phases interact. The black lines show the general flow through the phase. The red lines represent paths that can be taken to backtrack to a previous phase if a problem occurs. For example, during the process of producing an algorithm, an error or contradiction in the specification may be found, in which case the analysis and specification must be corrected. Likewise, an error in the program may indicate that an algorithm must be corrected.

All of Polya's phases are included in this outline of how we solve problems using the computer. The first step is always to understand

**?** **Amazon Packaging**

Have you ever received a big box from Amazon.com with only a small item inside? Seems like a waste, right? Well, it turns out there may be a good reason. Amazon uses an algorithm to determine, *not* the best box for you and your order, but the best box for the pallet, truck, or shipping container involved in the group of orders being processed. It tries to maximize efficiency and cost over multiple orders, not just yours.

### Analysis and specification phase

|                      |                                                   |
|----------------------|---------------------------------------------------|
| <i>Analyze</i>       | Understand (define) the problem.                  |
| <i>Specification</i> | Specify the problem that the program is to solve. |

### Algorithm development phase

|                          |                                                                               |
|--------------------------|-------------------------------------------------------------------------------|
| <i>Develop algorithm</i> | Develop a logical sequence of steps to be used to solve the problem.          |
| <i>Test algorithm</i>    | Follow the steps as outlined to see if the solution truly solves the problem. |

### Implementation phase

|             |                                                                                                                  |
|-------------|------------------------------------------------------------------------------------------------------------------|
| <i>Code</i> | Translate the algorithm (the general solution) into a programming language.                                      |
| <i>Test</i> | Have the computer follow the instructions. Check the results and make corrections until the answers are correct. |

### Maintenance phase

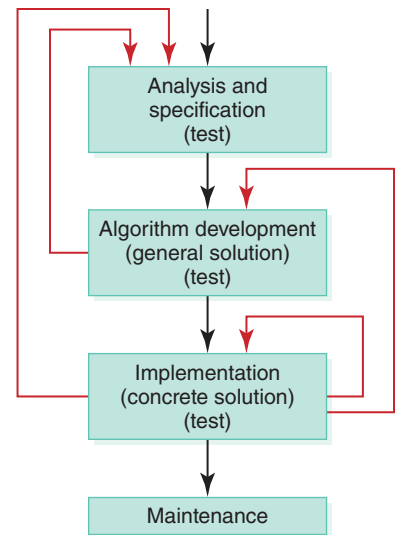
|                 |                                                                            |
|-----------------|----------------------------------------------------------------------------|
| <i>Use</i>      | Use the program.                                                           |
| <i>Maintain</i> | Modify the program to meet changing requirements or to correct any errors. |

**FIGURE 7.2** The computer problem-solving process

the problem. You cannot write a computer solution to a problem you don't understand. The next step is to develop a plan—an algorithm—for the solution and express it in pseudocode. It is this phase on which we concentrate in this chapter.

The next step is to implement the plan in such a way that the computer can execute it and test the results. In Polya's list, the human executes the plan and evaluates the results. In a computer solution, a program is written expressing the plan in a language that the computer can execute. But it is the human who takes the results of the computer program and checks them to confirm that they are correct. The maintenance phase maps to Polya's last stage, where the results are examined and perhaps modified.

In this chapter we end the process at the pseudocode level. This text is language neutral; that is, we do not cover a high-level language in detail. However, some of you may be learning one in parallel with this text. In any case, remember that an algorithm must be written before any coding in a programming language can be done.



**FIGURE 7.3** The interactions among the four problem-solving phases

## Summary of Methodology

The methodology for designing algorithms can be broken down into four major steps:

### 1. Analyze the Problem

Understand the problem! List the information you have to work with. This information will probably consist of the data in the problem. Specify what the solution will look like. If it is a report, specify the format. List any assumptions that you are making about the problem or the information. Think. How would you solve the problem by hand? Develop an overall algorithm or general plan of attack.

### 2. List the Main Tasks

The listing of the main tasks is called the *main module*. Use English or pseudocode to restate the problem in the main module. Use task names to divide the problem into functional areas. If the main module is too long, you are including too much detail for this level. Introduce any control structures that are needed at this point. Re-sequence the subparts logically, if needed. Postpone details to lower levels.



Don't worry if you don't know how to solve a task. Just pretend you have a "smart friend" who has the answer and postpone thinking about it until later. All you have to do in the main module is to give the names of lower-level modules that solve certain tasks. Use meaningful identifiers.

### 3. Write the Remaining Modules

There is no fixed number of levels. Modules at one level can specify more modules at lower levels. Each module must be complete, even if it references unwritten modules. Do successive refinements through each module until each statement is a concrete step.

### 4. Re-sequence and Revise as Necessary

Plan for change. Don't be afraid to start over. Several attempts and refinements may be necessary. Try to maintain clarity. Express yourself simply and directly.

The problem-solving strategy that parallels Polya's outline is known as *top-down design*. It produces a hierarchy of tasks to be solved. In Chapter 9, we introduce a strategy called *object-oriented design*, which produces a hierarchy of data objects.

## Testing the Algorithm

The goal of mathematical problem solving is to produce a specific answer to a problem, so checking the results is the equivalent of testing the process by which the answer was derived. If the answer is correct, the process is correct. However, the goal of computer problem solving is to create the right *process*. The algorithm that embodies this process may be used again and again with different data, so the process itself must be tested or verified.

Testing an algorithm often involves running the program into which the algorithm is coded under various conditions and examining the results for problems. However, this type of testing can be done only when the program is complete, or at least partially complete, which is far too late to rely on just this kind of testing. The earlier that problems are discovered and fixed, the cheaper and easier it is to address them.

Clearly, we need to perform testing at earlier stages in the development process. Specifically, the algorithms must be tested prior to implementing them. We demonstrated this process as we worked through the base-changing algorithm.

#### ?

#### Rosetta Stone as a translation system

The Rosetta Stone was unearthed by Napoleon's troops in 1799. The stone contained a proclamation marking the first anniversary of the coronation of Ptolemy V, inscribed in three languages: hieroglyphics, demotic (a cursive version of hieroglyphs), and Greek. Scholars were able to decipher the ancient Egyptian languages using the Greek as a guide. Thus the Rosetta Stone provided the key that unlocked the translation of Egyptian hieroglyphics. The Rosetta Stone can be seen in the British Museum in London.

## 7.2 Algorithms with Simple Variables

Simple (atomic) variables are those that cannot be divided. They are a value stored in a place. We used simple variables in the algorithms in Chapter 6.

### An Algorithm with Selection

Suppose you want to write an algorithm to express what dress is appropriate for a given outside temperature. You would like to wear shorts if it is hot, short sleeves if it is nice but not too hot, a light jacket if the temperature is chilly, and a heavy coat if it is cold. If the temperature is below freezing, you stay inside.

The top-level (main) module just expresses the tasks.

© Artur Debat/Getty Images, © Alan Dyer/Stocktrek Images/Getty Images

```
Write "Enter the temperature"
Read temperature
Determine dress
```

The first two statements do not need further decomposing. However, *Determine dress* does. We need to associate temperatures with our descriptions. Let's define *hot* as anything above 90, *nice* as above 70, *chilly* as above 50, and *cold* as above 32. Now we can write the pseudocode for *Determine dress*.

© Artur Debat/Getty Images, © Alan Dyer/Stocktrek Images/Getty Images

#### Determine dress

```
IF (temperature > 90)
 Write "Texas weather: wear shorts"
ELSE IF (temperature > 70)
 Write "Ideal weather: short sleeves are fine"
ELSE IF (temperature > 50)
 Write "A little chilly: wear a light jacket"
ELSE IF (temperature > 32)
 Write "Philadelphia weather: wear a heavy coat"
ELSE
 Write "Stay inside"
```

The only way to get to the second *if* statement is if the first expression is not true; thus, if the second expression is true, you know that the temperature is between 71 and 90. If the first and second expressions are not true and the third is, then the temperature is between 51 and 70. The same reasoning leads to the conclusion that Philadelphia weather is between 33 and 50, and “Stay inside” is written if the temperature is less than or equal to 32. Any one of the branches can contain a sequence of statements.

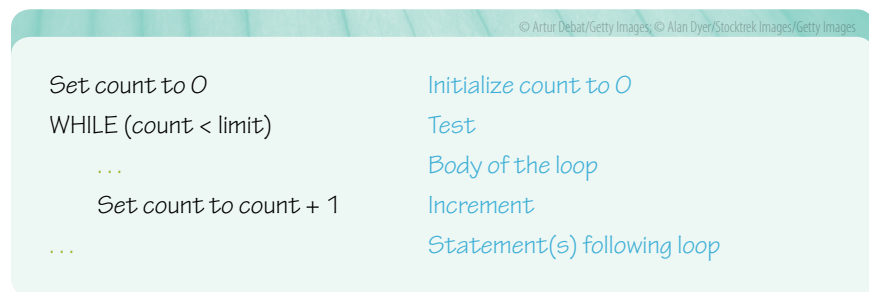
## Algorithms with Repetition

There are two basic types of loops: count controlled and event controlled.

### Count-Controlled Loops

A count-controlled loop is a loop that repeats a process a specified number of times. The looping mechanism simply counts each time the process is repeated and tests whether it has finished before beginning again. This was the type of loop we used in Chapter 6.

There are three distinct parts to this kind of loop, which makes use of a special variable called a *loop control variable*. The first part is initialization: The loop control variable is initialized to some starting value. The second part is testing: Has the loop control variable reached a predetermined value? The third part is incrementation: The loop control variable is incremented by 1. The following algorithm repeats a process *limit* times:



The loop control variable, *count*, is set to 0 outside the loop. The expression *count* < *limit* is tested, and the loop is executed as long as the expression is true. The last statement in the loop increments the loop

control variable, *count*. How many times does the loop execute? The loop executes when *count* is 0, 1, 2, . . . , *limit* - 1. Thus the loop executes *limit* times. The initial value of the loop control variable and the relational operator used in the Boolean expression determine the number of times the loop executes.

The *while* loop is called a *pretest loop*, because the testing takes place *before* the loop is executed. If the condition is false initially, the loop is not entered. What happens if the incrementation statement is omitted? The Boolean expression never changes. If the expression was false to begin with, nothing happens; the loop just is not executed. If the expression is true to begin with, the expression never changes, so the loop executes forever. Actually, most computing systems have a timer, so the program would not really run forever. Instead, the program would halt with an error message. A loop that never terminates is called an *infinite loop*.

This algorithm from Chapter 6 contains a count-controlled loop:

© Artur Debat/Getty Images, © Alan Dyer/Stocktrek Images/Getty Images

```
Write "How many pairs of values are to be entered?"
Read numberOfPairs
Set numberRead to 0
WHILE (numberRead < numberOfPairs)
 // Body of loop
 ...
 Set numberRead to numberRead + 1
```

Pep/9 used a semicolon to indicate that what followed was a comment and not part of the program. In our pseudocode, we use two forward slashes to preface a comment.

## Event-Controlled Loops

Loops in which the number of repetitions is controlled by an event that occurs within the body of the loop itself are called *event-controlled loops*. When implementing an event-controlled loop using a *while* statement, there are again three parts to the process: The event must be initialized,

## Chapter 7: Problem Solving and Algorithms

the event must be tested, and the event must be updated. The base conversion algorithm from Chapter 6 contains an event-controlled loop:

```

Write "Enter the new base"
Read newBase
Write "Enter the number to be converted"
Read decimalNumber
Set answer to 0
Set quotient to 1
WHILE (quotient is not zero)
 Set quotient to decimalNumber DIV newBase
 // Rest of loop body
Write "The answer is ", answer

```

A count-controlled loop is very straightforward: The process is repeated a specified number of times. The activity in an event-controlled loop is less clear cut. It may not be immediately apparent what the event should be.

Let's look at a couple of examples. First, let's read and sum data values until we read a negative value. What is the event? Reading a positive value. How do we initialize the event? We read the first data value. We test the value to determine whether it is positive and enter the loop if it is. How do we update the event? We read the next data value. Here is the algorithm:

```

Read a value Initialize event
WHILE (value >= 0) Test event
 ... Body of loop
 Read a value Update event
 ... Statement(s) following loop

```

Now let's write the algorithm for reading and summing positive values until 10 have been counted. We will ignore zero or negative values. What

is the event? The number of positive values read is less than 11. This means that we must keep a count of the number of positive values as we read them; let's call it `posCount`. How do we initialize the event? We set `posCount` to 0. We test `posCount` against 10, and exit the loop when `posCount` reaches 10. How do we update the event? We increment `posCount` each time we read a positive value.

|                                                               |                                     |
|---------------------------------------------------------------|-------------------------------------|
| Set <code>sum</code> to 0                                     | Initialize <code>sum</code> to zero |
| Set <code>posCount</code> to 0                                | Initialize event                    |
| WHILE ( <code>posCount</code> < 10)                           | Test event                          |
| Read a value                                                  |                                     |
| IF ( <code>value</code> > 0)                                  | Should count be updated?            |
| Set <code>posCount</code> to <code>posCount</code> + 1        | Update event                        |
| Set <code>sum</code> to <code>sum</code> + <code>value</code> | Add value into <code>sum</code>     |
| ...                                                           | Statement(s) following loop         |

This is not a count-controlled loop because we do not read 10 values: We read values until we have read 10.

Notice the selection control structure embedded within the loop. The statements to be executed or skipped in any control structure can be simple statements or compound statements (blocks of indented statements)—there is no constraint on what these statements can be. As a consequence, the statement to be skipped or repeated can contain a control structure. Selection statements can be nested within looping structures; looping structures can be nested within selection statements. Structures in which one control structure is embedded within another control structure are called **nested structures**.

Let's work through another example: finding the square root of a number.

## Square Root

Most students have to compute a square root in school. A rather complicated algorithm has been developed that works on integer values. We do not look at that algorithm here, but rather use a much simpler approximation that works on real numbers as well as integers.

**Nested structure (nested logic)** A structure in which one control structure is embedded within another

## Chapter 7: Problem Solving and Algorithms

Given the number of which you wish to find the square root, take the number and make a guess at the answer; then take the guess and square it. If your guess is correct, the guess squared is equal to the original value. If it is not, you adjust your guess and begin again. This process continues until the guess squared is close enough. Do you understand the problem? If not, reread this paragraph.

Now let's outline the major tasks:

© Artur Debat/Getty Images, © Alan Dyer/Stocktrek Images/Getty Images

*Read in square*  
*Calculate the square root*  
*Write out square and the square root*

*Read in square* does not need further expansion. *Calculate the square root* *does* need further expansion, because it is the heart of the algorithm. Clearly there is a loop: We keep refining the guess until the guess is good enough. Is it a count-controlled loop or an event-controlled loop? Because we have no idea how many iterations the process will take, it must be an event-controlled loop.

What do we mean by “good enough”? Let's say that if the difference between the guess squared and the original value is within plus or minus 0.001, the guess is good enough; we'll call this difference *epsilon*. How do we measure “plus or minus”? We take the absolute value of the difference. We indicate this by the expression  $abs(epsilon)$ , which stands for *absolute value*.

© Artur Debat/Getty Images, © Alan Dyer/Stocktrek Images/Getty Images

### Calculate square root

Set *epsilon* to 1  
 WHILE (*epsilon* > 0.001)  
   Calculate new guess  
   Set *epsilon* to  $abs(square - guess * guess)$



Now the only step that needs further expansion is *Calculate new guess*. Now we need to ask questions: What is the formula for calculating the new guess? We search online for “square root formula” and find the answer in Wikipedia. We replace the old guess by the average between the old guess and the square divided by the old guess.

© Artur Debat/Getty Images, © Alan Dyer/Stocktrek Images/Getty Images

### Calculate new guess

Set *newGuess* to  $(\textit{guess} + (\textit{square}/\textit{guess})) / 2.0$

In looking up the formula, we find that we had forgotten something: What is the original guess? Any positive value will work, but the solution is found with fewer iterations if the original guess is closer to the square root. A good approximation for the original guess is the square divided by 4. We do not need to have variables for old guess and new guess. We can call it *guess* and just keep changing its value. Here, then, is the completed algorithm:

© Artur Debat/Getty Images, © Alan Dyer/Stocktrek Images/Getty Images

```

Read in square
Set guess to square/4
Set epsilon to 1
WHILE (epsilon > 0.001)
 Calculate new guess
 Set epsilon to abs(square - guess * guess)
Write out square and the guess

```

Let’s desk check this algorithm with a value to which we know the answer: 81. **FIGURE 7.4** shows the algorithm walk-through. It takes only four iterations to get the answer correct to five decimal places.

A step that needs to be expanded further is called an **abstract step**. A step that does not need to be expanded is called a **concrete step**. From here on we will color the abstract steps red. Each abstract step must be expanded separately.

**Abstract step** An algorithmic step for which some details remain unspecified

**Concrete step** A step for which the details are fully specified

|                            |                |              |
|----------------------------|----------------|--------------|
| (a) Initial values         |                |              |
| <i>square</i>              | <i>epsilon</i> | <i>guess</i> |
| 81                         | 1              | 20.25        |
| (b) After first iteration  |                |              |
| <i>square</i>              | <i>epsilon</i> | <i>guess</i> |
| 81                         | 66.0156        | 12.125       |
| (c) After second iteration |                |              |
| <i>square</i>              | <i>epsilon</i> | <i>guess</i> |
| 81                         | 7.410          | 9.403        |
| (d) After third iteration  |                |              |
| <i>square</i>              | <i>epsilon</i> | <i>guess</i> |
| 81                         | 0.155          | 9.009        |
| (e) After fourth iteration |                |              |
| <i>square</i>              | <i>epsilon</i> | <i>guess</i> |
| 81                         | 0.000          | 9.0000       |

FIGURE 7.4 Walk-through of the square root algorithm

?

### Bathroom Connectivity

At the 2018 Consumer Electronics Expo (CES), developers unveiled an Internet-connected toilet that plays streaming music and responds to voice commands such as “lift the seat” and “flush.” Do you think you’d want this product?

## 7.3 Composite Variables

The places to store values described previously were all atomic in nature; that is, each place could hold only one piece of data, which cannot be divided into smaller parts. We have also used a string of letters within quotations to represent a message to be written out. As you might expect, letters within quotations are called *strings*. If we were to store a string, the number of locations required would depend on the number of characters in the string. Thus a string is not atomic because it contains more than one value, but we tend to think of strings as atomic anyway because we do not access the individual letters.

In this section, we describe two ways of collecting data items together, giving the collection a name, and accessing the items individually or as a collection.

### Arrays

An array is a named collection of *homogeneous* items in which individual items are accessed by their place within the collection. The place within the collection is called an *index*. Although people usually start counting at one, most programming languages start at zero—so that is what

we will do here. **FIGURE 7.5** shows an array with 10 items indexed from 0 through 9.

If the array is called *numbers*, we access each value by the expression `numbers[position]`

where *position*, the index, is a value between 0 and 9.

Here is the algorithm to put values into the places in an array:

```
integer numbers[10]
// Declares numbers to hold 10 integer values
Write "Enter 10 integer numbers, one per line"
Set position to 0 // Set variable position to 0
WHILE (position < 10)
 Read in numbers[position]
 Set position to position + 1
// Continue with processing
```

|     |      |
|-----|------|
| [0] | 1066 |
| [1] | 1492 |
| [2] | 1668 |
| [3] | 1945 |
| [4] | 1972 |
| [5] | 1510 |
| [6] | 999  |
| [7] | 1001 |
| [8] | 21   |
| [9] | 2001 |

**FIGURE 7.5** An array of ten numbers

We indicate that *numbers* is an array that can hold integer values by listing *integer* followed by the array name with the number of slots in brackets beside the name. In our algorithms previously, we have not listed a variable; we have just assumed that when we use a variable name that the variable exists. Now that we are using composite structures, we need to say which kind of a structure we want.

Algorithms with arrays are classified into three categories: searching, sorting, and processing. *Searching* is just what it says—going through the items in the array one at a time looking for a particular value. *Sorting* is putting the items in the array into order. If the items are numbers, they would be put into numeric order; if the items are characters or strings, they would be put into alphabetic order. A sorted array is one in which the items are in order. *Processing* is a catch-all phrase that encompasses all other computing done to or with items in an array.

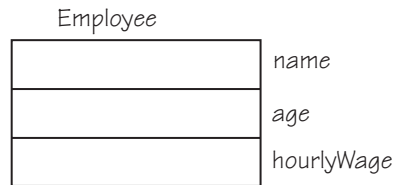
## Records

A record is a named *heterogeneous* group of items in which individual items are accessed by name. “Heterogeneous” means that the elements in the collection do not have to be the same. The collection can contain integers, real values, strings, or any other type of data. Records are good choices for bundling items together that relate to the same object. For example,

## ?

**Malware-infected software**

It's likely that pirated software contains malware, according to the FBI. Beware of software that is obtained from unknown sellers and peer-to-peer (P2P) networks.<sup>2</sup>



**FIGURE 7.6** Record *Employee*

we might read in a name, an age, and an hourly wage. These three items could then be bound together into a record called *Employee*. This record is made up of three fields: *name*, *age*, and *hourlyWage*. We might draw them as seen in [FIGURE 7.6](#).

If we declare a record variable *employee* of type *Employee*, each field of the record is accessed by the record variable, dot, and the field name. For example, *employee.name* refers to the *name* field of the record variable *employee*. There are no specific algorithms designed for records, because they are just a way of grouping related items. However, they are very handy ways to refer to a group of related items.

The following algorithm stores values into the fields of the record:

© Artur Debat/Getty Images, © Alan Dyer/Stocktrek Images/Getty Images

```
Employee employee // Declare an Employee variable
Set employee.name to "Frank Jones"
Set employee.age to 32
Set employee.hourlyWage to 27.50
```

A third composite data structure called a *class* characterizes object-oriented programming. We discuss this structure in Chapter 9.

## 7.4 Searching Algorithms

The act of searching is a common activity for humans as well as computers. When you look for a name in a directory, for instance, you are performing a search. We explore two search algorithms in this section.

### Sequential Search

Our first searching algorithm follows the most straightforward concept of a search. We look at each item in turn and compare it to the one for

which we are searching. If it matches, we have found the item. If not, we look at the next item. We stop either when we have found the item or when we have looked at all the items and not found a match. This sounds like a loop with two ending conditions. Let's write the algorithm using the array *numbers*.

```
© Artur Debat/Getty Images, © Alan Dyer/Stocktrek Images/Getty Images

Set position to 0
Set found to FALSE
WHILE (position < 10 AND found is FALSE)
 IF (numbers[position] equals searchItem)
 Set found to TRUE
 ELSE
 Set position to position + 1
```

Because we have a compound condition in the WHILE expression, we need to say a little more about Boolean variables. AND is a Boolean operator. The Boolean operators include the special operators AND, OR, and NOT. The AND operator returns TRUE if both expressions are TRUE, and FALSE otherwise. The OR operator returns FALSE if both expressions are FALSE, and TRUE otherwise. The NOT operator changes the value of the expression. These operations are consistent with the functionality of the gates described in Chapter 4. At that level, we were referring to the flow of electricity and the representation of individual bits. At this level, the logic is the same, but we can talk in terms of an expression as being either true or false.

We can simplify the second Boolean expression (*found is FALSE*) by using the NOT operator. NOT *found* is true when *found* is false. So we can say

```
WHILE (position < 10 AND NOT found)
```

Thus, the loop will repeat as long as the index is less than 10 and we haven't found the matching item.

## Sequential Search in a Sorted Array

If we know that the items in the array are sorted, we can stop looking when we pass the place where the item would be if it were present in the array. As we look at this algorithm, let's generalize our search somewhat. Rather than being specific about the number of items in the array, we use

## Chapter 7: Problem Solving and Algorithms

| Length | List |                |
|--------|------|----------------|
| 6      | 60   | [0]            |
|        | 75   | [1]            |
|        | 95   | [2]            |
|        | 80   | [3]            |
|        | 65   | [4]            |
|        | 90   | [5]            |
|        |      |                |
|        |      |                |
|        |      |                |
|        |      |                |
|        |      | [MAX_LENGTH-1] |

FIGURE 7.7 An unsorted array

a variable *length* to tell us how many valid items are in the array. The *length* might be less than the size, which is the number of slots in the array. As data is being read into the array, a counter is updated so that we always know how many data items were stored. If the array is called *data*, the data with which we are working is from *data[0]* to *data[length - 1]*. FIGURES 7.7 and 7.8 show an unordered array and a sorted array, respectively.

In the sorted array, if we are looking for 76, we know it is not in the array as soon as we examine *data[3]*, because this position is where the number would be if it were there. Here is the algorithm for searching in a sorted array embedded in a complete program. We use the variable *index* rather than *position* in this algorithm. Programmers often use the mathematical identifier *index* rather than the intuitive identifier *position* or *place* when working with arrays.

| Length | List |                |
|--------|------|----------------|
| 6      | 60   | [0]            |
|        | 65   | [1]            |
|        | 75   | [2]            |
|        | 80   | [3]            |
|        | 90   | [4]            |
|        | 95   | [5]            |
|        |      |                |
|        |      |                |
|        |      |                |
|        |      |                |
|        |      | [MAX_LENGTH-1] |

FIGURE 7.8 A sorted array

© Artur Debat/Getty Images, © Alan Dyer/Stocktrek Images/Getty Images

Read in array of values

Write "Enter value for which to search"

Read searchItem

Set found to TRUE if searchItem is there

IF (found)

Write "Item is found"

ELSE

Write "Item is not found"

© Artur Debat/Getty Images, © Alan Dyer/Stocktrek Images/Getty Images

Read in array of values

Write "How many values?"

Read length

Set index to 0

WHILE (index &lt; length)

Read data[index]

Set index to index + 1

© Artur Debat/Getty Images, © Alan Dyer/Stocktrek Images/Getty Images

Set found to TRUE if searchItem is there

Set index to 0

Set found to FALSE

WHILE (index &lt; length AND NOT found)

IF (data[index] equals searchItem)

Set found to TRUE

ELSE IF (data[index] &gt; searchItem)

Set index to length

ELSE

Set index to index + 1



## Binary Search

How would you go about looking for a word in a dictionary? We certainly hope you wouldn't start on the first page and sequentially search for your word! A sequential search of an array begins at the beginning of the array and continues until the item is found or the entire array has been searched without finding the item.

A binary search looks for an item in an array using a different strategy: divide and conquer. This approach mimics what you probably do when you look up a word. You start in the middle and then decide whether your word is in the right-hand section or the left-hand section. You then look in the correct section and repeat the strategy.

The **binary search** algorithm assumes that the items in the array being searched are sorted, and it either finds the item or eliminates half of the array with one comparison. Rather than looking for the item starting at the beginning of the array and moving forward sequentially, the algorithm begins at the middle of the array in a binary search. If the item for which we are searching is less than the item in the middle, we know that the item won't be in the second half of the array. We then continue by searching the data in the first half of the array. See [FIGURE 7.9](#).

### Binary search

Looking for an item in an already sorted list by eliminating large portions of the data on each comparison

| Length | Items       |
|--------|-------------|
| 11     | ant [0]     |
|        | cat [1]     |
|        | chicken [2] |
|        | cow [3]     |
|        | deer [4]    |
|        | dog [5]     |
|        | fish [6]    |
|        | goat [7]    |
|        | horse [8]   |
|        | rat [9]     |
|        | snake [10]  |
|        | .           |
|        | .           |
|        | .           |

FIGURE 7.9 Binary search example

Once again we examine the “middle” element (which is really the item 25% of the way into the array). If the item for which we are searching is greater than the item in the middle, we continue searching between the middle and the end of the array. If the middle item is equal to the one for which you are searching, the search stops. The process continues in this manner, with each comparison cutting in half the portion of the array where the item might be. It stops when the item is found or when the portion of the array where the item might be is empty.

© Artur Debat/Getty Images, © Alan Dyer/Stocktrek Images/Getty Images

### Boolean binary search

```

Set first to 0
Set last to length-1
Set found to FALSE
WHILE (first <= last AND NOT found)
 Set middle to (first + last)/ 2
 IF (item equals data[middle])
 Set found to TRUE
 ELSE
 IF (item < data[middle])
 Set last to middle - 1
 ELSE
 Set first to middle + 1
Return found

```

Let’s desk check (walk through) the algorithm, searching for *cat*, *fish*, and *zebra*. Rather than boxes, we use a tabular form in **FIGURE 7.10** to save space.

Is the binary search algorithm really faster than the sequential search algorithm? **TABLE 7.1** shows the number of comparisons required on average to find an item using a sequential search and using a binary search. If the binary search is so much faster, why don’t we always use it? More computations are required for each comparison in a binary search because we must calculate the middle index.

**TABLE**

**7.1**

### Average Number of Comparisons

| Length | Sequential Search | Binary Search |
|--------|-------------------|---------------|
| 10     | 5.5               | 2.9           |
| 100    | 50.5              | 5.8           |
| 1000   | 500.5             | 9.0           |
| 10000  | 5000.5            | 12.0          |

© Artur Debat/Getty Images, © Alan Dyer/Stocktrek Images/Getty Images

Searching for *cat*

| First | Last | Middle | Comparison                                                                     |
|-------|------|--------|--------------------------------------------------------------------------------|
| 0     | 10   | 5      | <i>cat</i> < <i>dog</i>                                                        |
| 0     | 4    | 2      | <i>cat</i> < <i>chicken</i>                                                    |
| 0     | 1    | 0      | <i>cat</i> > <i>ant</i>                                                        |
| 1     | 1    | 1      | <i>cat</i> = <i>cat</i> <span style="float: right;"><b>Return: true</b></span> |

Searching for *fish*

| First | Last | Middle | Comparison                                                                       |
|-------|------|--------|----------------------------------------------------------------------------------|
| 0     | 10   | 5      | <i>fish</i> > <i>dog</i>                                                         |
| 6     | 10   | 8      | <i>fish</i> < <i>horse</i>                                                       |
| 6     | 7    | 6      | <i>fish</i> = <i>fish</i> <span style="float: right;"><b>Return: true</b></span> |

Searching for *zebra*

| First | Last | Middle | Comparison                                                                         |
|-------|------|--------|------------------------------------------------------------------------------------|
| 0     | 10   | 5      | <i>zebra</i> > <i>dog</i>                                                          |
| 6     | 10   | 8      | <i>zebra</i> > <i>horse</i>                                                        |
| 9     | 10   | 9      | <i>zebra</i> > <i>rat</i>                                                          |
| 10    | 10   | 10     | <i>zebra</i> > <i>snake</i>                                                        |
| 11    | 10   |        | <i>first</i> > <i>last</i> <span style="float: right;"><b>Return: false</b></span> |

FIGURE 7.10 Trace of the binary search

Also, the array must already be sorted. If the array is already sorted and the number of items is more than 20, a binary search algorithm is the better choice.

## 7.5 Sorting

We all know what sorting is. We sort our music playlist, our bookshelves, even our priorities. Sorting is putting things in order. In computing, transforming an unsorted array into a sorted array is a common and useful operation. Entire books have been written about sorting algorithms. The goal is to come up with better, more efficient sorts. Because sorting a large number of elements can be extremely time consuming, a good sorting algorithm is highly desirable. In fact, this is one area in which programmers are sometimes encouraged to sacrifice clarity in favor of speed of execution.

In this section, we present several diverse sorting algorithms to give you a flavor of how many different ways there are to solve the same problem.

## Selection Sort

If we handed you a set of index cards with names and asked you to put them in order by name, you would probably go through the cards looking for the name that comes first in the alphabet. You would then put that card as the first in a new stack. How would you determine which card comes first? You might turn the first card sideways to remember it. If you found one that comes before the turned card, you could turn the first card back and turn the new “first” card to remember it. When you have examined all the cards, the one that is turned up is the first one. You pull it out to start the sorted deck of cards. This process would continue until all the index cards have been moved to the new stack.

© Artur Debat/Getty Images, © Alan Dyer/Stocktrek Images/Getty Images

```
WHILE more cards in first deck
 Find smallest left in first deck
 Move to new deck
```

The selection sort algorithm is probably the easiest because it mirrors how we would sort a list of values if we had to do it by hand. Our deck of index cards is an array of names. The new deck is an array of sorted names. We remove items from the first and put them into successive places in the second. We remember the smallest so far by saving its position in a temporary variable.

This algorithm is simple, but it has one drawback: It requires space for two complete decks (arrays). Although we have not talked about memory space considerations, this duplication is clearly wasteful. A slight adjustment to this by-hand approach does away with the need to duplicate space, however. As you move the smallest item to the new array, a free space opens up where it used to be. Instead of writing this name on a second list, we can exchange it with the name currently in the position where the new name should go. This “by-hand list” is represented in an array.

## Chapter 7: Problem Solving and Algorithms

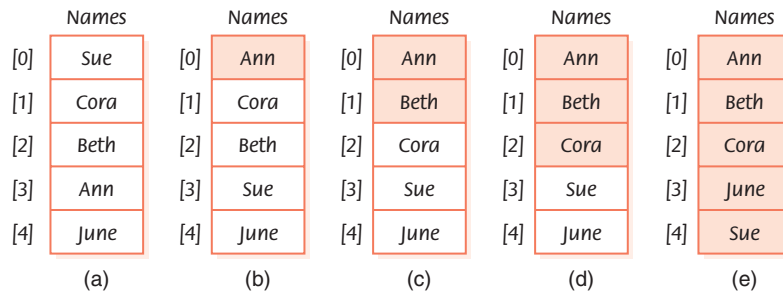


FIGURE 7.11 Examples of selection sort (sorted elements are shaded)

Let's look at an example—sorting the five-element array shown in [FIGURE 7.11](#). Because of this algorithm's simplicity, it is usually the first sorting method that students learn.

Let's visualize the array as containing two parts: the unsorted part (not shaded) and the sorted part (shaded). Each time we add an item into its proper place, we are shrinking the unsorted part and extending the sorted part. Sorting begins with all of the items in the unsorted part and ends with all of the items in the sorted part. Here is the algorithm written to mirror this visualization:

### Selection sort

Set firstUnsorted to 0

WHILE (*not sorted yet*)

*Find smallest unsorted item*

*Swap firstUnsorted item with the smallest*

Set firstUnsorted to firstUnsorted + 1

This algorithm includes only three abstract steps (colored in red): determining when the array is sorted, finding the index of the smallest element, and swapping the contents of two places. In moving from Figure 7.11(d) to 7.11(e), we added the last two items to the shaded part of the array. This is always the case because when the smaller of the last two items is put into its proper place, the last item is also in its proper

place. Thus the loop continues as long as `firstUnsorted` is less than the length of array  $- 1$ .

© Artur Debat/Getty Images, © Alan Dyer/Stocktrek Images/Getty Images

### Not sorted yet

```
firstUnsorted < length - 1
```

How would you find the name that comes first in the alphabet in the unsorted portion of the list if you were sorting it by hand? You see (and mentally record) the first one, and then you scan down the list (turning index cards) until you see one that comes before the first one. You remember this smaller one and continue scanning the list for a name that comes before this one in the alphabet. The process of remembering the smallest so far until you find a smaller one is repeated until you reach the end of the list. This by-hand algorithm is exactly the one we use here, except that we must remember the index of the smallest item because we will swap it with the item in the `firstUnsorted` position. Stated in terms of our list, we look for the smallest item in the unsorted portion, which runs from `firstUnsorted` through `length - 1`.

© Artur Debat/Getty Images, © Alan Dyer/Stocktrek Images/Getty Images

### Find smallest unsorted item

```
Set indexOfSmallest to firstUnsorted
Set index to firstUnsorted + 1
WHILE (index <= length - 1)
 IF (data[index] < data[indexOfSmallest])
 Set indexOfSmallest to index
 Set index to index + 1
```

How many glasses does it take to swap the contents of two glasses? Three. You need a glass to temporarily hold the contents of one glass while you pour the contents of the other glass into the first. Swapping the contents of two places in memory is exactly the same problem. The swap algorithm must have the indexes of the two items to be swapped.

Swap firstUnsorted with smallest

```
Set tempItem to data[firstUnsorted]
Set data[firstUnsorted] to data[indexOfSmallest]
Set data[indexOfSmallest] to tempItem
```

## ?

**What is piggybacking?**

Using another subscriber's wireless Internet access service without the subscriber's explicit permission or knowledge is called *piggybacking*. Is it ethical? Some compare it to reading the newspaper over the shoulder of the person in front of you while on a train. Others compare it to entering a home just because the door is unlocked. Is it legal? Some jurisdictions permit it, some prohibit it, and others are not well defined. What do you think?

**Bubble Sort**

The bubble sort is a selection sort that uses a different scheme for finding the minimum value. Starting with the last array element, we compare successive pairs of elements, swapping them whenever the bottom element of the pair is smaller than the one above it [ FIGURE 7.12(a) ]. In this way, the smallest element “bubbles up” to the top of the array. Each iteration puts the smallest unsorted item into its correct place using the same technique, but it also changes the locations of the other elements in the array [ FIGURE 7.12(b) ].

Before we write this algorithm, we must make an observation: The bubble sort is a very slow sorting algorithm. Sorting algorithms are usually compared based on the number of iterations it takes to sort an array, and

|     | Names | Names | Names | Names | Names |
|-----|-------|-------|-------|-------|-------|
| [0] | Phil  | Phil  | Phil  | Phil  | Al    |
| [1] | Al    | Al    | Al    | Al    | Phil  |
| [2] | John  | John  | Bob   | Bob   | Bob   |
| [3] | Jim   | Bob   | John  | John  | John  |
| [4] | Bob   | Jim   | Jim   | Jim   | Jim   |

(a) First iteration (sorted elements are shaded)

|     | Names | Names | Names | Names |
|-----|-------|-------|-------|-------|
| [0] | Al    | Al    | Al    | Al    |
| [1] | Phil  | Bob   | Bob   | Bob   |
| [2] | Bob   | Phil  | Jim   | Jim   |
| [3] | John  | Jim   | Phil  | John  |
| [4] | Jim   | John  | John  | Phil  |

(b) Remaining iterations (sorted elements are shaded)

**FIGURE 7.12** Examples of a bubble sort

this approach takes one iteration for every item in the array except the last. Also, during each algorithm a lot of swapping goes on. Why, then, do we bother to mention the bubble sort if it is so inefficient? Because a very slight change in the sorting algorithm makes it an excellent choice to use in certain circumstances. Let's apply the algorithm to an already sorted array. See the rightmost column in Figure 7.12(b).

We compare Phil with John and do not swap them. We compare John with Jim and do not swap them. We compare Jim with Bob and do not swap them. We compare Bob with Al and do not swap them. If no values are swapped during an iteration, then the array is sorted. We set a Boolean variable to FALSE before we enter the loop and set it to TRUE if a swap occurs. If the Boolean variable is still FALSE, then the array is sorted.

Compare the processing of the bubble sort to the selection sort on an already sorted array. The selection sort algorithm gives us no way to determine whether the array is sorted; therefore, we will go through the entire algorithm.

© Artur Debat/Getty Images, © Alan Dyer/Stocktrek Images/Getty Images

### Bubble sort

```
Set firstUnsorted to 0
Set swap to TRUE
WHILE (firstUnsorted < length - 1 AND swap)
 Set swap to FALSE
 "Bubble up" the smallest item in unsorted part
 Set firstUnsorted to firstUnsorted + 1
```

© Artur Debat/Getty Images, © Alan Dyer/Stocktrek Images/Getty Images

### Bubble up

```
Set index to length - 1
WHILE (index > firstUnsorted)
 IF (data[index] < data[index - 1])
 Swap data[index] and data[index - 1]
 Set swap to TRUE
 Set index to index - 1
```



## Insertion Sort

If you have only one item in the array, it is sorted. If you have two items, you can compare and swap them if necessary. Now the first two are sorted with respect to themselves. Take the third item and put it into its place relative to the first two. Now the first three items are sorted with respect to one another. The item being added to the sorted portion can be bubbled up as in the bubble sort. When you find a place where the item being inserted is smaller than the item in the array, you store the item there. `current` is the item being inserted into the sorted portion. See [FIGURE 7.13](#).

### Insertion sort

```

Set current to 1
WHILE (current < length)
 Set index to current
 Set placeFound to FALSE
 WHILE (index > 0 AND NOT placeFound)
 IF (data[index] < data[index - 1])
 Swap data[index] and data[index - 1]
 Set index to index - 1
 ELSE
 Set placeFound to TRUE
 Set current to current + 1

```

At each iteration of a selection sort, one more item is put into its permanent place. At each iteration of an insertion sort, one more item is put into its proper place with respect to those above it.

|     | Names | Names | Names | Names | Names |
|-----|-------|-------|-------|-------|-------|
| [0] | Phil  | John  | Al    | Al    | Al    |
| [1] | John  | Phil  | John  | Jim   | Bob   |
| [2] | Al    | Al    | Phil  | John  | Jim   |
| [3] | Jim   | Jim   | Jim   | Phil  | John  |
| [4] | Bob   | Bob   | Bob   | Bob   | Phil  |

**FIGURE 7.13** Insertion sort

## 7.6 Recursive Algorithms

When an algorithm uses its own name within itself, it is called a *recursive algorithm*. That is, if a task name at one level calls itself, the call is known as a *recursive call*. **Recursion**—the ability of an algorithm to call itself—is an alternative control structure to repetition (looping). Rather than use a looping statement to execute an algorithm segment, such an algorithm uses a selection statement to determine whether to repeat the algorithm by calling it again or to stop the process.

Each recursive algorithm has at least two cases: the *base case* and the *general case*. The base case is the one to which we have an answer; the general case expresses the solution in terms of a call to itself with a smaller version of the problem. Because the general case solves an ever smaller and smaller version of the original problem, eventually the program reaches the base case, where an answer is known. At this point, the recursion stops.

Associated with each recursive problem is some measure of the size of the problem. The size must become smaller with each recursive call. The first step in any recursive solution is, therefore, to determine the *size factor*. If the problem involves a numerical value, the size factor might be the value itself. If the problem involves a structure, the size factor is probably the size of the structure.

So far, we have given a name to a task at one level and expanded the task at a lower level. Then we have collected all of the pieces into the final algorithm. With recursive algorithms, we must be able to give the algorithm data values that are different each time we execute the algorithm. Thus, before we continue with recursion, we must look at a new control structure: the *subprogram statement*. Although we are still at the algorithm level, this control structure uses the word *subprogram*.

### Subprogram Statements

We can give a section of code a name and then use that name as a statement in another part of the program. When the name is encountered, the processing in the other part of the program halts while the named code executes. When the named code finishes executing, processing resumes with the statement just below where the name occurred. The place where the name of the code appears is known as the *calling unit*.

Two basic forms of subprograms exist: named code that does a particular task (void subprograms) and named code that also does a task but returns a single value to the calling unit (value-returning subprograms).

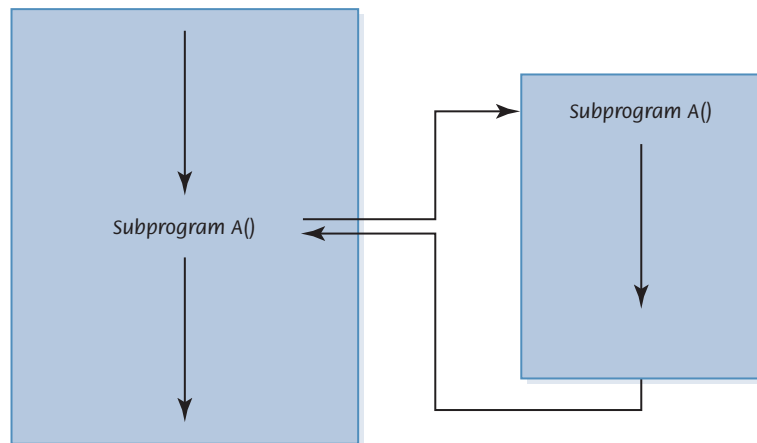
**Recursion** The ability of an algorithm to call itself

## Chapter 7: Problem Solving and Algorithms

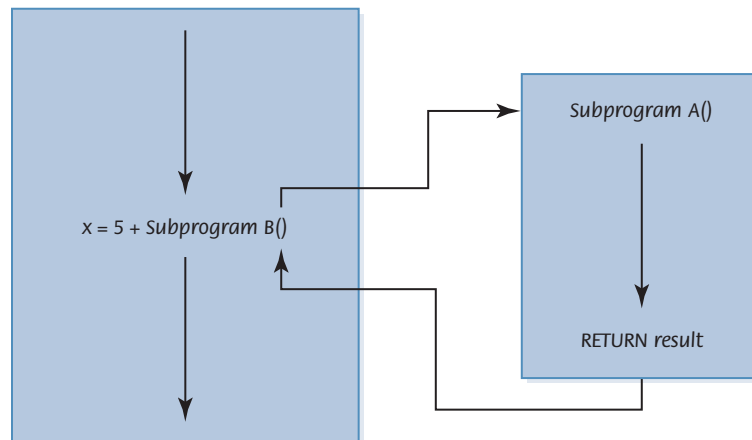
The first form is used as a statement in the calling unit; the second form is used in an expression in the calling unit where the returned value is then used in the evaluation of the expression.

Subprograms are powerful tools for abstraction. The listing of a named subprogram allows the reader of the program to see that a task is being done without having to be bothered with the details of the task's implementation. If a subprogram needs information to execute its task, we place the name of the data value in parentheses by the subprogram heading. If the subprogram returns a value to the calling unit, it uses the word RETURN followed by the name of the data to be returned. See [FIGURE 7.14](#).

(a) Subprogram A does its task and the calling unit continues with the next statement



(b) Subprogram B does its task and returns a value that is added to 5 and stored in x



**FIGURE 7.14** Subprogram flow of control

## Recursive Factorial

The factorial of a number is defined as the number multiplied by the product of all the numbers between itself and 0:

$$N! = N * (N - 1)!$$

The factorial of 0 is 1. The size factor is the number for which we are calculating the factorial. We have a base case:

Factorial(0) is 1.

We also have a general case:

Factorial(N) is  $N * \text{Factorial}(N - 1)$ .

An *if* statement can evaluate N to see if it is 0 (the base case) or greater than 0 (the general case). Because N is clearly getting smaller with each call, the base case is eventually reached.

© Artur Debat/Getty Images, © Alan Dyer/Stocktrek Images/Getty Images

```
Write "Enter N"
Read N
Set result to Factorial(N)
Write result + " is the factorial of " + N
```

© Artur Debat/Getty Images, © Alan Dyer/Stocktrek Images/Getty Images

### Factorial(N)

```
IF (N equals 0)
 RETURN 1
ELSE
 RETURN N * Factorial(N - 1)
```

Each time *Factorial* is called, the value of N gets smaller. The data being given each time is called the *argument*. What happens if the argument is a negative number? The subprogram just keeps calling itself until the run-time support system runs out of memory. This situation, which is called *infinite recursion*, is equivalent to an infinite loop.

## Recursive Binary Search

Although we coded the binary search using a loop, the binary search algorithm sounds recursive. We stop when we find the item or when we know it isn't there (base cases). We continue to look for the item in the section of the array where it will be if it is present at all. A recursive algorithm must be called from a nonrecursive algorithm as we did with the factorial algorithm. Here the subprogram needs to know the *first* and *last* indices within which it is searching. Instead of resetting *first* or *last* as we did in the iterative version, we simply call the algorithm again with the new values for *first* and *last*.

© Artur Debat/Getty Images, © Alan Dyer/Stocktrek Images/Getty Images

### BinarySearch (first, last)

```

IF (first > last)
 RETURN FALSE
ELSE
 Set middle to (first + last) / 2
 IF (item equals data[middle])
 RETURN TRUE
 ELSE
 IF (item < data[middle])
 BinarySearch (first, middle - 1)
 ELSE
 BinarySearch (middle + 1, last)

```

?

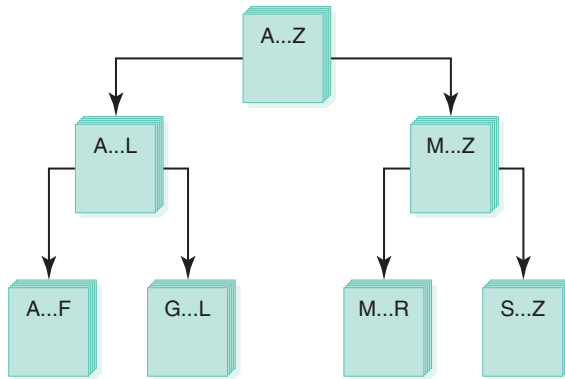
### Was Plato a software designer?

Philosophy has spent 2500 years working on concepts now integral to software design. For example, Plato's universals and particulars can be viewed as the classes and instances of classes in object-oriented programming.<sup>3</sup>

## Quicksort

The Quicksort algorithm, developed by C. A. R. Hoare, is based on the idea that it is faster and easier to sort two small lists than one larger one. The name comes from the fact that, in general, Quicksort can sort a list of data elements quite rapidly. The basic strategy of this sort is “divide and conquer.”

If you were given a large stack of final exams to sort by name, you might use the following approach: Pick a splitting value, say *L*, and divide the stack of tests into two piles, *A–L* and *M–Z*. (Note that the two piles do not necessarily contain the same number of tests.) Then take the first pile and subdivide it into two piles, *A–F* and *G–L*. The *A–F* pile can be further



**FIGURE 7.15** Ordering a list using the Quicksort algorithm

broken down into A–C and D–F. This division process goes on until the piles are small enough to be easily sorted by hand. The same process is applied to the M–Z pile.

Eventually, all of the small, sorted piles can be stacked one on top of the other to produce a sorted set of tests. See [FIGURE 7.15](#).

This strategy is based on recursion—on each attempt to sort the stack of tests, the stack is divided, and then the same approach is used to sort each of the smaller stacks (a smaller case). This process continues until the small stacks do not need to be divided further (the base case). The variables *first* and *last* in the Quicksort algorithm reflect the part of the array *data* that is currently being processed.

© Artur Debat/Getty Images; © Alan Dyer/Stocktrek Images/Getty Images

### Quicksort(first, last)

IF (first < last) // There is more than one item

Select splitVal

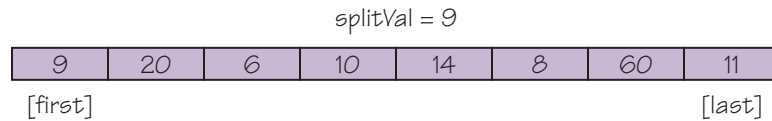
Split (splitVal) // Array between first and  
 // splitPoint - 1 <= splitVal  
 // data[splitPoint] = splitVal  
 // Array between splitPoint + 1  
 // and last > splitVal

Quicksort (first, splitPoint - 1)

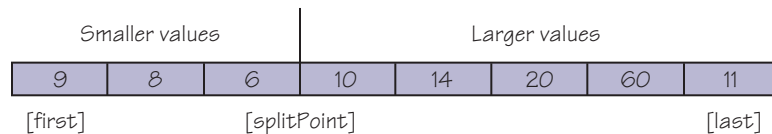
Quicksort (splitPoint + 1, last)

## Chapter 7: Problem Solving and Algorithms

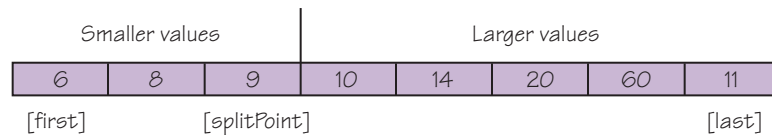
How do we select `splitVal`? One simple solution is to use whatever value is in `data[first]` as the splitting value. Let's look at an example using `data[first]` as `splitVal`.



After the call to `Split`, all items less than or equal to `splitVal` are on the left side of the array and all items greater than `splitVal` are on the right side of the array.



The two “halves” meet at `splitPoint`, the index of the last item that is less than or equal to `splitVal`. Note that we don't know the value of `splitPoint` until the splitting process is complete. We can then swap `splitVal` (`data[first]`) with the value at `data[splitPoint]`.



Our recursive calls to `Quicksort` use this index (`splitPoint`) to reduce the size of the problem in the general case.

`Quicksort(first, splitPoint - 1)` sorts the left “half” of the array. `Quicksort(splitPoint + 1, last)` sorts the right “half” of the array. (The “halves” are not necessarily the same size.) `splitVal` is already in its correct position in `data[splitPoint]`.

What is the base case? When the segment being examined has only one item, we do not need to go on. That is represented in the algorithm by the missing `else` statement. If there is only one value in the segment being sorted, it is already in its place.

We must find a way to get all elements that are equal to or less than `splitVal` on one side of `splitVal` and all elements that are greater than `splitVal`

on the other side. We do this by moving a pair of the indexes from the ends toward the middle of the array, looking for items that are on the wrong side of the split value. When we find pairs that are on the wrong side, we swap them and continue working our way into the middle of the array.

© Artur Debat/Getty Images, © Alan Dyer/Stocktrek Images/Getty Images

### Split(splitVal)

Set left to first + 1

Set right to last

WHILE (left <= right)

    Increment left until data[left] > splitVal OR left > right

    Decrement right until data[right] < splitVal OR left > right

    IF(left < right)

        Swap data[left] and data[right]

Set splitPoint to right

Swap data[first] and data[splitPoint]

Return splitPoint

Although we still have an abstract step, we can stop, because we have already expanded this abstract step in an earlier problem. This brings up a very important point: *Never reinvent the wheel*. An abstract step in one algorithm may have been solved previously either by you or by someone else. **FIGURE 7.16** shows an example of this splitting algorithm.

Quicksort is an excellent sorting approach if the data to be sorted is in random order. If the data is already sorted, however, the algorithm degenerates so that each split has just one item in it.

Recursion is a very powerful and elegant tool. Nevertheless, not all problems can easily be solved recursively, and not all problems that have an obvious recursive solution should be solved recursively. Even so, a recursive solution is preferable for many problems. If the problem statement logically falls into two cases (a base case and a general case), recursion is a viable alternative.



## Chapter 7: Problem Solving and Algorithms

(a) Initialization

|         |        |   |    |    |   |    |         |
|---------|--------|---|----|----|---|----|---------|
| 9       | 20     | 6 | 10 | 14 | 8 | 60 | 11      |
| [first] | [left] |   |    |    |   |    | [right] |

(b) Increment left until  $\text{list}[\text{left}] > \text{splitVal}$  or  $\text{left} > \text{right}$

|         |        |   |    |    |   |    |         |
|---------|--------|---|----|----|---|----|---------|
| 9       | 20     | 6 | 10 | 14 | 8 | 60 | 11      |
| [first] | [left] |   |    |    |   |    | [right] |

(c) Decrement right until  $\text{list}[\text{right}] \leq \text{splitVal}$  or  $\text{left} > \text{right}$

|         |        |   |    |    |         |    |    |
|---------|--------|---|----|----|---------|----|----|
| 9       | 20     | 6 | 10 | 14 | 8       | 60 | 11 |
| [first] | [left] |   |    |    | [right] |    |    |

(d) Swap  $\text{list}[\text{left}]$  and  $\text{list}[\text{right}]$ ; move left and right toward each other

|         |   |        |    |         |    |    |    |
|---------|---|--------|----|---------|----|----|----|
| 9       | 8 | 6      | 10 | 14      | 20 | 60 | 11 |
| [first] |   | [left] |    | [right] |    |    |    |

(e) Increment left until  $\text{list}[\text{left}] > \text{splitVal}$  or  $\text{left} > \text{right}$

Decrement right until  $\text{list}[\text{right}] \leq \text{splitVal}$  or  $\text{left} > \text{right}$

|         |   |         |        |    |    |    |    |
|---------|---|---------|--------|----|----|----|----|
| 9       | 8 | 6       | 10     | 14 | 20 | 60 | 11 |
| [first] |   | [right] | [left] |    |    |    |    |

(f)  $\text{left} > \text{right}$  so no swap occurs within the loop

Swap  $\text{list}[\text{first}]$  and  $\text{list}[\text{right}]$

|         |   |              |    |    |    |    |    |
|---------|---|--------------|----|----|----|----|----|
| 6       | 8 | 9            | 10 | 14 | 20 | 60 | 11 |
| [first] |   | [right]      |    |    |    |    |    |
|         |   | (splitPoint) |    |    |    |    |    |

FIGURE 7.16 Splitting algorithm

## 7.7 Important Threads

In the last two chapters, we have mentioned several topics in passing that are important not only in problem solving but also in computing in general. Let's review some of the common threads discussed in these chapter.

### Information Hiding

We have mentioned the idea of deferring the details several times. We have used it in the context of giving a name to a task and not worrying about how the task is to be implemented until later. Deferring the details in a design has distinct advantages. The designer sees just those details that are relevant at a particular level of the design. This practice, called **information hiding**, makes the details at a lower level inaccessible during the design of the higher levels.

This practice must seem very strange! Why shouldn't the details be accessible while the algorithm is being designed? Shouldn't the designer

#### Information hiding

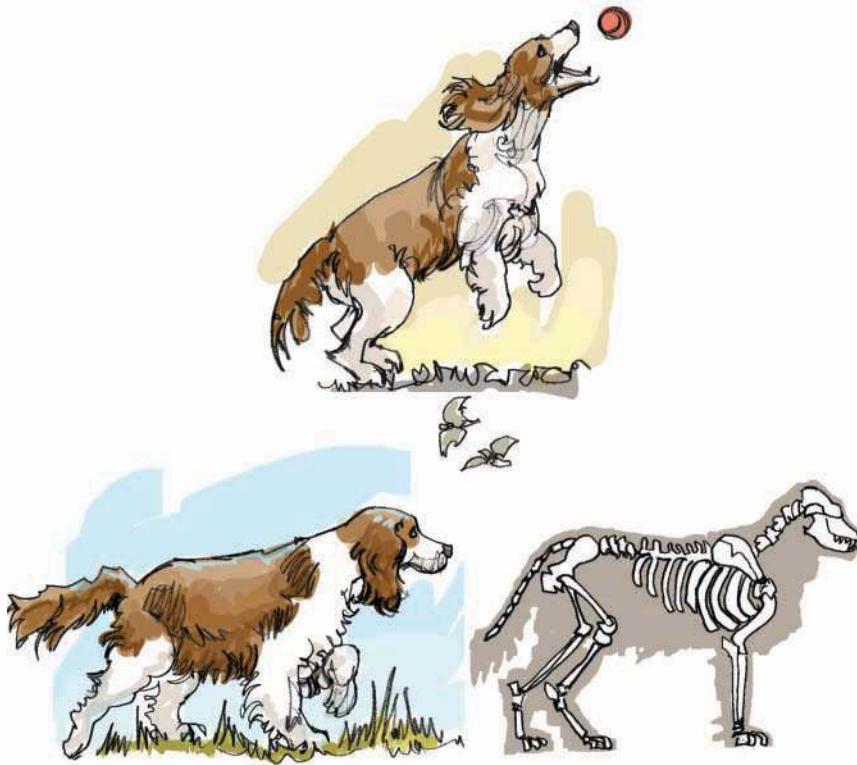
The practice of hiding the details of a module with the goal of controlling access to the details of the module

know everything? No. If the designer knows the low-level details of a module, he or she is more likely to base the module's algorithm on these details—and it is precisely these low-level details that are more likely to change. If they do, then the entire module has to be rewritten.

## Abstraction

**Abstraction** and information hiding are two sides of the same coin. Information hiding is the practice of hiding details; abstraction is the result with the details hidden. As we said in Chapter 1, an abstraction is a model of a complex system that includes only the details that are essential for the viewer to know. Take, for example, Daisy, the English spaniel. To her owner, she is a household pet; to a hunter, she is a bird dog; and to the vet, she is a mammal. Her owner watches Daisy's wagging tail, hears her yelp when she gets left outside, and sees the hair she leaves everywhere. The hunter sees a finely trained helper who knows her job and does it well. The vet sees all of the organs, flesh, and bones of which she is composed. See **FIGURE 7.17**.

**Abstraction** A model of a complex system that includes only the details essential to the viewer



**FIGURE 7.17** Different views of the same concept

In computing, an algorithm is an abstraction of the steps needed to implement it. The casual user of a program that includes the algorithm, who sees only the description of how to run the program, is like the dog owner: He or she sees only the surface. The programmer, who incorporates another's algorithm in her program, is like the hunter who uses the well-trained dog: He or she uses the algorithm for a purpose. The implementer of the algorithm, who must understand it thoroughly, is like the vet: He or she must see the inner workings to implement the algorithm.

In computing, various kinds of abstraction are apparent. **Data abstraction** refers to the view of data; it is the separation of the logical view of data from its implementation. For example, your bank's computer may represent numbers in two's complement or one's complement, but this distinction is of no concern to you as long as your bank statements are accurate.

**Procedural abstraction** refers to the view of actions; it is the separation of the logical view of an action from its implementation. For example, when we gave a name to a subprogram, we were practicing procedural abstraction.

A third kind of abstraction in computing is called **control abstraction**. Control abstraction refers to the view of a control structure; it is the separation of the logical view of a control structure from its implementation. A **control structure** lets us alter this sequential flow of control of an algorithm. WHILE and IF are control structures. How these control structures are implemented in the languages into which we might translate an algorithm is immaterial to the design of the algorithms.

*Abstraction is the most powerful tool people have for managing complexity.* This statement is true in computing as well as real life.

## Naming Things

When we write algorithms, we use shorthand phrases to stand for the tasks and data with which we are dealing. We give names to data and processes. These names are called *identifiers*. For example, we used `newBase` and `decimalNumber` in the base-changing algorithm. We also gave names to tasks. For example, we used `Split` to name the task of splitting an array in the Quicksort algorithm. Our identifiers for data values were created from a combination of the words, using uppercase to make the meaning clearer. We left the names of tasks as phrases. Eventually the task names must be converted to a single identifier.

When we get to the stage where we translate an algorithm into a program in a language that a computer can execute, we may have to modify

### Data abstraction

The separation of the logical view of data from its implementation

### Procedural abstraction

The separation of the logical view of an action from its implementation

### Control abstraction

The separation of the logical view of a control structure from its implementation

### Control structure

A statement used to alter the normally sequential flow of control

the identifiers. Each language has its own rules about forming identifiers. So there is a two-stage process: Data and actions are given names in the algorithm, and then these names are translated into identifiers that meet the rules of the computer language. Notice that giving identifiers to data and actions is a form of abstraction.

## Testing

We have demonstrated testing at the algorithm phase using algorithm walk-throughs. We have shown how to design test plans and implemented one in assembly language. Testing is important at every stage in programming. There are basically two types of testing: clear-box testing, which is based on the code itself, and black-box testing, which is based on testing all possible input values. Often, a test plan incorporates both types of testing.

© Artur Debat/Getty Images, © Alan Dyer/Stocktrek Images/Getty Images

## SUMMARY

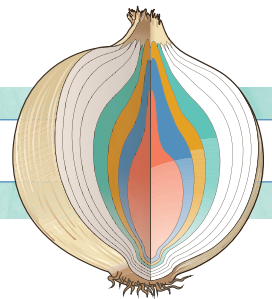
Polya, in his classic book *How to Solve It*, outlined a problem-solving strategy for mathematical problems. This strategy can be applied to all problems, including those for which a computer program is to be written. These strategies include asking questions, looking for familiar things, and dividing and conquering; when these strategies are applied, they should lead to a plan for solving a problem. In computing, such a plan is called an *algorithm*.

Two categories of loops are distinguished: count controlled and event controlled. A count-controlled loop executes the loop a predetermined number of times. An event-controlled loop executes until an event within the loop changes.

Data comes in two forms: atomic (simple) and composite. An array is a homogeneous structure that gives a name to a collection of items and allows the user to access individual items by position within the structure.

Searching is the act of looking for a particular value in an array. In this chapter we examined the linear search in an unsorted array, the linear search in a sorted array, and the binary search in a sorted array. Sorting is the act of putting the items in an array into some kind of order. The selection sort, bubble sort, insertion sort, and Quicksort are four commonly used sorting algorithms.

Recursive algorithms are algorithms for which the name of a subprogram appears in the subprogram itself. The factorial and binary search are naturally recursive algorithms.





## ETHICAL ISSUES

### Open-Source Software<sup>4,5</sup>

If an application you purchased from a proprietary software vendor breaks, you cannot pop open the hood, tinker with the source code, and continue working away. The source code is owned and copyrighted by the manufacturer, and modifying, copying, or reselling it to others is illegal.

Open-source software offers an alternative to this proprietary arrangement. Open-source applications allow users to modify the source code in any way they like. They can add to it, change it, or extend it. They can also copy it, give it away to others, or even sell it. The only proviso is that those to whom the revised code is further distributed have the same freedoms to access the source code, copy, or sell the software. This passing along of the freedoms of use is sometimes referred to as “copyleft” and is highly prized by open-source supporters.

When proprietary software made its first appearance, some parties in the computing community saw it as a threat to the freedom of intellectual collaboration. They believed that software is essentially an intellectual product and, therefore, is best served by being treated as an idea: Anyone is welcome to join the debate, add an opinion, and bring friends into the conversation. Furthermore, if a person cannot gain access to software except by purchasing it from a proprietary vendor, then that individual is barred from joining the

discussion until he or she hands over cash to the owner of the “idea.”

In response to the changing landscape of computing in the 1980s, some MIT computer scientists formed the Free Software Foundation (FSF) to promote the open use and sharing of software. The Boston-based group developed the General Public License (GPL), which outlines the rules under which users can share, distribute, and collaborate on developing software products. For those who feel “free” might be an erroneous name, FSF points out, it means “free as in free speech, not free as in free beer.”

So what makes this seemingly simple idea so controversial? If anyone can upgrade or improve the product, doesn’t this increase its value to users? Not according to opponents of the open-source ethic. Microsoft and other proprietary software producers view open-source code as a threat to their businesses. If people can fix and modify the source code on their own, they will not want to pay the licensing fees required to use the proprietary products, nor will they want to purchase upgrades. Even more important, opponents claim, is the danger to intellectual property rights posed by the open-source model.

Open-source supporters point to the more cost-effective aspects of the model. Even if users initially pay for the software, the freedoms granted under the licensing



## ETHICAL ISSUES

### Open-Source Software (CONTINUED)

agreement do not lock them into that choice. They can mix and match software to best suit the needs of their mission. Fans of the open-source model also note that such software tends to be more reliable, causing less downtime and requiring internal IT departments and engineers to spend less time fixing low-level problems that might otherwise cause great disruption. Those opposed to the use of software that allows anyone access to the source code claim that it poses much greater security risks than proprietary packages. For example, if airlines, hospitals, and municipal infrastructures are using it, they leave themselves much more vulnerable to attack than if they use packages where only the maker has access to the source code.

Perhaps the most famous example of open-source software is the Linux operating system, which is licensed under the Free Software Foundation's General Public License. The success of Linux has given great hope to the open-source community. This operating system is extremely popular and is even used, if somewhat sparingly, by government agencies. Versions of Linux are sold by a variety of vendors, including Red Hat, the best-known Linux distributor. Such examples serve as confirmation that the open-source model is commercially viable.

Proprietary producers have been working to block proposals that would require

governments to shift to using open-source products. For now, patent and copyright laws continue to favor proprietary software. Whether this continues to be the case remains to be seen. Microsoft has suggested limiting open-source software in various ways, but so far has not proved successful in its quest. For now, the debate continues over whether the open-source model is a benefit for all, or a danger to business and property rights.

In 2008, the open-source software community reached a legal milestone. The case in question centered on free software used in developing commercial software products for model trains. The software's creator, open-source software group Java Model Railroad Interface, claimed that when Matthew Katzer used its software to create commercial products without following the terms of the software license associated with the software, he had infringed on copyright laws. The software license stated that anyone using the free code had to credit the author, emphasize the source of the files, and explain how the code had been adapted. After a lower court ruling sided with Katzer, a federal appeals court ruled that open-source artistic licensing agreements could be upheld by copyright laws, enforcing the rights of companies using open-source software to protect their ideas.

## KEY TERMS

Abstract step  
 Abstraction  
 Algorithm  
 Binary search  
 Concrete step  
 Control abstraction

Control structure  
 Data abstraction  
 Information hiding  
 Nested structure (nested logic)  
 Procedural abstraction  
 Recursion

## EXERCISES

For Exercises 1–6, match the problem-solving strategy with the definition or example.

- A. Ask questions
  - B. Look for familiar things
  - C. Divide and conquer
1. The first strategy to use when given a problem
  2. Don't reinvent the wheel.
  3. Strategy used in the binary search algorithms
  4. Is a solution to a previous problem appropriate for the current one?
  5. Strategy used in the Quicksort algorithm
  6. There is an apparent contradiction in the problem statement.

For Exercises 7–10, match the phase with its output.

- A. Analysis and specification phase
- B. Algorithm development phase

- C. Implementation phase
  - D. Maintenance phase
7. Working program
  8. None
  9. Problem statement
  10. General solution

For Exercises 11–15, match the term with the definition.

- A. Information hiding
  - B. Abstraction
  - C. Data abstraction
  - D. Procedural abstraction
  - E. Control abstraction
11. The practice of hiding the details of a module with the goal of controlling access to the details of the module.
  12. A model of a complex system that includes only details that are essential to the viewer.
  13. The separation of the logical view of an action from its implementation.



**EXERCISES (CONTINUED)**

14. The separation of the logical view of a control structure from its implementation.
15. The separation of the logical view of data from its implementation.

For Exercises 16–36, mark the answers true or false as follows:

- A. True
- B. False
16. Count-controlled loops repeat a specific number of times.
17. Event-controlled loops repeat a specific number of times.
18. Count-controlled loops are controlled by a counter.
19. Event-controlled loops are controlled by an event.
20. An infinite loop is a loop that never terminates.
21. Loops can be nested, but selection structures cannot.
22. Selection structures can be nested, but loops cannot.
23. All control structures can be nested.
24. The square root algorithm uses a count-controlled loop.
25. An array is a homogeneous structure, but a record is not.
26. A record is a heterogeneous structure, but an array is not.
27. A record is a homogeneous structure; an array is a heterogeneous structure.
28. The bubble sort algorithm involves finding the smallest item in the unsorted portion of the array and swapping it with the first unsorted item.
29. Quicksort is not always quick.
30. A binary search can be applied to both a sorted array and an unsorted array.
31. A binary search is always faster than a linear search.
32. A selection sort puts one more item into its permanent place at each iteration.
33. An insertion sort puts one more item into its place with respect to the already sorted portion.
34. *Recursion* is another word for *iteration*.
35. Recursive algorithms use IF statements.
36. Iterative algorithms use WHILE statements.

Exercises 37–62 are short-answer questions.

37. List the four steps in Polya's How to Solve It list.
38. Describe the four steps listed in Exercise 37 in your own words.
39. List the problem-solving strategies discussed in this chapter.
40. Apply the problem-solving strategies to the following situations.
  - a. Buying a toy for your four-year-old cousin
  - b. Organizing an awards banquet for your soccer team
  - c. Buying a dress or suit for an awards banquet at which you are being honored



**EXERCISES (CONTINUED)**

41. Examine the solutions in Exercise 40 and determine three things they have in common.
42. What is an algorithm?
43. Write an algorithm for the following tasks.
  - a. Making a peanut butter and jelly sandwich
  - b. Getting up in the morning
  - c. Doing your homework
  - d. Driving home in the afternoon
44. List the phases of the computer problem-solving model.
45. How does the computer problem-solving model differ from Polya's problem-solving model?
46. Describe the steps in the algorithm development phase.
47. Describe the steps in the implementation phase.
48. Describe the steps in the maintenance phase.
49. Look up a recipe for chocolate brownies in a cookbook and answer the following questions.
  - a. Is the recipe an algorithm? Justify your answer.
  - b. Organize the recipe as an algorithm, using pseudocode.
  - c. List the words that have meaning in computing.
  - d. List the words that have meaning in cooking.
  - e. Make the brownies and take them to your professor.
50. We said that following a recipe is easier than developing one. Go to the supermarket and buy a vegetable that you have not cooked (or eaten) before. Take it home and develop a recipe. Write up your recipe and your critique of the process. (If it is good, send it to the authors.)
51. Describe the top-down design process.
52. Differentiate between a concrete step and an abstract step.
53. Write a top-down design for the following tasks.
  - a. Buying a toy for your four-year-old cousin
  - b. Organizing an awards banquet for your soccer team
  - c. Buying a dress or suit for an awards banquet at which you are being honored
54. Write a top-down design for the following tasks.
  - a. Calculating the average of ten test scores
  - b. Calculating the average of an unknown number of test scores
  - c. Describing the differences in the two designs
55. Write a top-down design for the following tasks.
  - a. Finding a telephone number in the phone book
  - b. Finding a telephone number on the Internet

**EXERCISES (CONTINUED)**

- c. Finding a telephone number on a scrap of paper that you have lost
  - d. Describe the differences among these designs.
56. Distinguish between information and data.
  57. Write a top-down design for sorting a list of names into alphabetical order.
  58.
    - a. Why is information hiding important?
    - b. Name three examples of information hiding that you encounter every day.
  59. An airplane is a complex system.
    - a. Give an abstraction of an airplane from the view of a pilot.
    - b. Give an abstraction of an airplane from the view of a passenger.
    - c. Give an abstraction of an airplane from the view of the cabin crew.
    - d. Give an abstraction of an airplane from the view of a maintenance mechanic.
    - e. Give an abstraction of an airplane from the view of the airline's corporate office.
  60. List the identifiers and indicate whether they named

data or actions for the designs in Exercise 53.

61. List the identifiers and indicate whether they named data or actions for the designs in Exercise 54.
62. List the identifiers and indicate whether they named data or actions for the designs in Exercise 55.

Exercises 63–65 use the following array of values.

| length | list |     |     |     |     |     |     |     |     |     |      |
|--------|------|-----|-----|-----|-----|-----|-----|-----|-----|-----|------|
| 11     | [0]  | [1] | [2] | [3] | [4] | [5] | [6] | [7] | [8] | [9] | [10] |
|        | 23   | 41  | 66  | 20  | 2   | 90  | 9   | 34  | 19  | 40  | 99   |

63. Show the state of the list when `firstUnsorted` is first set equal to the fourth item in the selection sort.
64. Show the state of the list when `firstUnsorted` is first set equal to the fifth item in the bubble sort algorithm.
65. Show the state of the list when the first recursive call is made in Quicksort using `list[0]` as the split value.

Exercises 66 and 67 use the following array of values.

| length | list |     |     |     |     |     |     |     |     |     |      |
|--------|------|-----|-----|-----|-----|-----|-----|-----|-----|-----|------|
| 11     | [0]  | [1] | [2] | [3] | [4] | [5] | [6] | [7] | [8] | [9] | [10] |
|        | 5    | 7   | 20  | 33  | 44  | 46  | 48  | 99  | 101 | 102 | 105  |

**EXERCISES (CONTINUED)**

66. How many comparisons does it take using a sequential search to find the following values or determine that the item is not in the list?
- a. 4
  - b. 44
  - c. 45
  - d. 105
  - e. 106
67. How many comparisons does it take using a binary search to find the following values or determine that the item is not in the list?
- a. 4
  - b. 44
  - c. 46
  - d. 105
  - e. 106

## THOUGHT QUESTIONS

1. Top-down design creates scaffolding that is used to write a program. Is all of this scaffolding just a waste of effort? Is it ever used again? Of what value is it after the program is up and running?
2. Which of the problem-solving strategies do you use the most? Can you think of some others that you use? Would they be appropriate for computing problem solving?
3. There are several common examples of open-source software that many people use in their everyday lives. Can you name any?
4. Do you believe that the quality of an open-source software product is likely to be higher or lower than the quality of software produced by a large corporation? How do you think technical support for open-source software compares to that for proprietary software?
5. Daniel Bricklin (whose biography appears in Chapter 12) did not patent or copyright his software, believing that software should not be proprietary. As a result, he lost a great deal of money in the form of possible royalties. Do you consider his actions to be visionary or naive?
6. The Free Software Foundation is a tax-exempt charity that raises funds for work on the GNU Project. GNU software is free. Read about its philosophy on the Web. Compare GNU products with those of manufacturers such as Microsoft and Sun.
7. If you were to continue with computing and become a programmer, which side of the argument would you take: Should software be copyrighted or should it be free?

## Laying the Groundwork

- 1 The Big Picture

## The Information Layer

- 2 Binary Values and Number Systems
- 3 Data Representation

## The Hardware Layer

- 4 Gates and Circuits
- 5 Computing Components

## The Programming Layer

- 6 Low-Level Programming Languages and Pseudocode
- 7 Problem Solving and Algorithms
- 8 Abstract Data Types and Subprograms
- 9 Object-Oriented Design and High-Level Programming Languages

## The Operating Systems Layer

- 10 Operating Systems
- 11 File Systems and Directories

## The Applications Layer

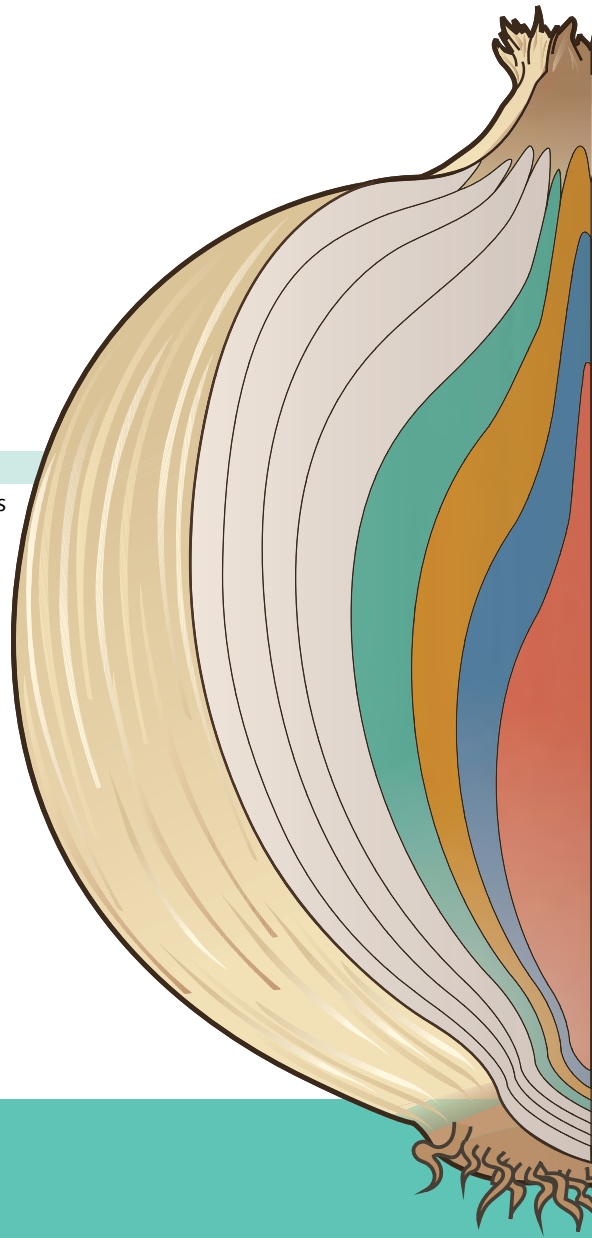
- 12 Information Systems
- 13 Artificial Intelligence
- 14 Simulation, Graphics, Gaming, and Other Applications

## The Communications Layer

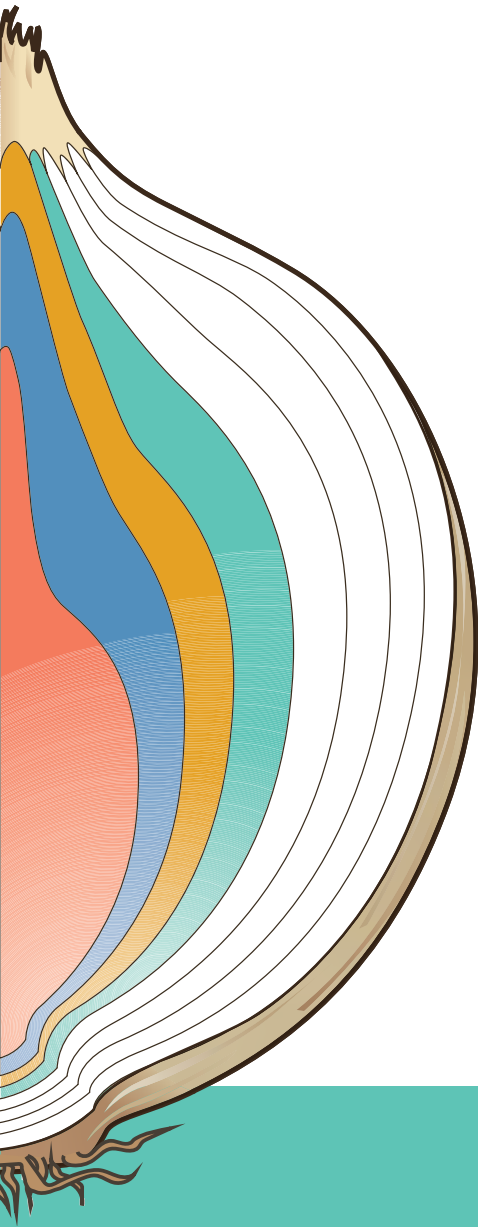
- 15 Networks
- 16 The World Wide Web
- 17 Computer Security

## In Conclusion

- 18 Limitations of Computing



# THE PROGRAMMING LAYER



# ABSTRACT DATA TYPES AND SUBPROGRAMS

## 8

In the programming layer, we have moved from the concreteness of machine language, to assembly language, to pseudocode, to expressing algorithms. We then went from algorithms using simple variables to algorithms using arrays.

Now we take a step up in abstraction and talk about abstract containers: composite structures for which we do not know the implementation. In computing circles, these abstract containers are called *abstract data types*. We know their properties and operations and we understand which types of values they can contain, but we have no information about their internal structure or implementation. That is, we know what the operations are and what they do, but we do not know how the operations are implemented.

The algorithm design we have been using is a top-down model, in which we break a task into smaller pieces. We conclude this chapter with more about subprogram statements, which are both a way to make the code mirror the design and the way that algorithms and subalgorithms communicate.

## GOALS

After studying this chapter, you should be able to:

- distinguish between an array-based visualization and a linked visualization.
- distinguish between an array and a list.
- distinguish between an unsorted list and a sorted list.
- distinguish between the behavior of a stack and the behavior of a queue.
- distinguish between a binary tree and a binary search tree.
- draw the binary search tree that is built from inserting a series of items.
- understand the difference between a tree and a graph.
- explain the concept of subprograms and parameters and distinguish between value and reference parameters.

## 8.1 What Is an Abstract Data Type?

**Abstract data type (ADT)** A container whose properties (data and operations) are specified independently of any particular implementation

**Data structure** The implementation of a composite data field in an abstract data type

**Containers** Objects whose role is to hold and manipulate other objects

An **abstract data type (ADT)** is a container whose properties (data and operations) are specified independently of any particular implementation. For example, we can discuss a list of items and the ability to add and remove things in the list without getting into the details of how the items in the list are stored or how the add and remove operations are carried out. The list serves a concrete purpose but can be discussed in an abstract way. Recall that the goal in design is to reduce complexity through abstraction.

To put the concept of an ADT into context, we need to look at how we view data. In computing, we view data from three perspectives: the application level, the logical level, and the implementation level.

The application (or user) level is the view of the data within a particular problem. The logical (or abstract) level is an abstract view of the data values (the domain) and the operations that manipulate them. The implementation level is a specific representation of the structure that holds the data items and the coding of the operations in a programming language. This view sees the properties represented as specific data fields and subprograms. It is concerned with **data structures**, the implementation of a composite data field in an abstract data type.

The abstract data types that we examine in this chapter are those that history and experience have shown come up again and again in real-world problems. These ADTs are containers in which data items are stored, and each exhibits specific behaviors. They are called **containers** because their sole purpose is to hold other objects.

## 8.2 Stacks

The first two abstract data structures we will explore are stacks and queues, which are often thought of as a pair—like peanut butter and jelly. Why this is so may be more for historical reasons than anything else, because these two structures have quite different behaviors.

A stack is an abstract composite structure in which accesses are made at only one end. You can insert an item as the first one and you can remove the first one. This type of processing is referred to as *LIFO*, which stands for “last in, first out.” This design models many things in real life, such as a plate holder in a cafeteria: We can take only the top plate. When we do so, the plate below rises to the top so the next person can take one. Canned goods on a grocer’s shelf also exhibit this property. When we take the first can in a row, we are taking the last can put in that row.

Another way of stating the accessing behavior of a stack is to say that the item removed is the item that has been in the stack the shortest time. Viewing a stack from this perspective is abstract. The insertion operation has no constraints; the entire LIFO behavior is specified through the removal operation.

The mental image of the cafeteria plates has left an imprint on the traditional names used for the insertion and removal operations. Adding an item to the stack is called *Push*; removing an item is called *Pop*. We *Push* an item onto the stack, and we *Pop* an item off the stack. A stack does not have the property of length, so there is no operation that returns the number of items on the stack. We do need operations that determine whether a stack is *IsEmpty*, however, because trying to *Pop* an item when the stack is empty is an error.

Here is an algorithm that reads in numbers and prints them in reverse order using a stack. We have not colored the stack operations in red because they have already been implemented by someone else; they are ours to use. Because the *more data* is not relevant to our discussion, we leave it unexpanded here and in the following algorithms.

© Artur Debat/Getty Images, © Alan Dyer/Stocktrek Images/Getty Images

```
WHILE (more data)
 Read value
 Push(myStack, value)
WHILE (NOT IsEmpty(myStack))
 Pop(myStack, value)
 Write value
```

Desk-check this algorithm to convince yourself that the values are, indeed, written in reverse order.

## 8.3 Queues

A queue is an abstract structure in which items are entered at one end and removed from the other end. This behavior is called *FIFO*, which stands for “first in, first out.” This ADT sounds like a waiting line in a bank or supermarket. Indeed, queues are used to simulate this type of situation. Insertions are made at the rear of the queue, and removals are made from the front of the queue.



Another way of stating the accessing behavior of a queue is to say that the item removed is the item that has been in the queue the longest time. Viewing a queue from this perspective is more abstract. Like the stack, the insert operation has no constraints; the entire FIFO behavior is specified in the removal operation. Unfortunately, there is no standard queue terminology relating to the insertion and deletion operations. *Enqueue*, *Enque*, *Enq*, *Enter*, and *Insert* are all names used for the insertion operation. *Dequeue*, *Deque*, *Deq*, *Delete*, and *Remove* are names used for the deletion operation.

Here is an algorithm that reads in data values and prints them in the order in which they were entered:

© Artur Debat/Getty Images, © Alan Dyer/Stocktrek Images/Getty Images

```

WHILE (more data)
 Read value
 Enque(myQueue, value)
WHILE (NOT IsEmpty(myQueue))
 Deque(myQueue, value)
 Write value

```

## 8.4 Lists

Lists occur as naturally in programming as they do in real life. We manipulate guest lists, grocery lists, class lists, and things-to-do lists. The list of lists is endless. Three properties characterize lists: The items are homogeneous, the items are linear, and lists have varying lengths. By *linear*, we mean that each item except the first has a unique component that comes before it, and each item except the last has a unique component that comes after it. For example, if there are at least three items in a list, the second item comes after the first and before the third.

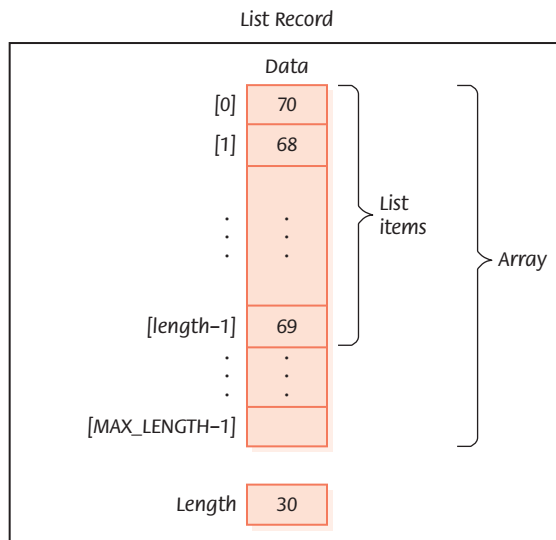
Whereas stacks and queues have all the semantics in the deletion operation, lists usually provide operations to insert an item (*Insert*), delete an item (*Delete*), check whether an item is there (*IsThere*), and report the number of items in a list (*GetLength*). In addition, they have some mechanism for allowing the user to view each item in sequence (*Reset*, *GetNext*, *MoreItems*). Because items can be deleted and retrieved, the items in the list must be able to be compared.

*Do not mistake a list for an array.* An array is a structure that's part of a programming language; a list is an abstract structure. However, a list may be implemented using an array, as shown in **FIGURE 8.1**.

### ?

#### Jumping jacks in the classroom

The UTeach Institute, a University of Texas teacher-training program, launched an initiative in late 2013 to support the use of mobile devices in the classroom. To demonstrate the technology, students at Kealing Middle School in Austin did jumping jacks and then held their fingers to a tablet's camera, which measured their heart rates. The data was gathered directly into a spreadsheet projected on the wall. Students could see that over time, exercise would lower their resting heart rates, so their hearts would pump blood more efficiently. Verizon Wireless donated more than \$1 million in equipment and cash grants to support this work in the use of tablets for teaching.<sup>1</sup>

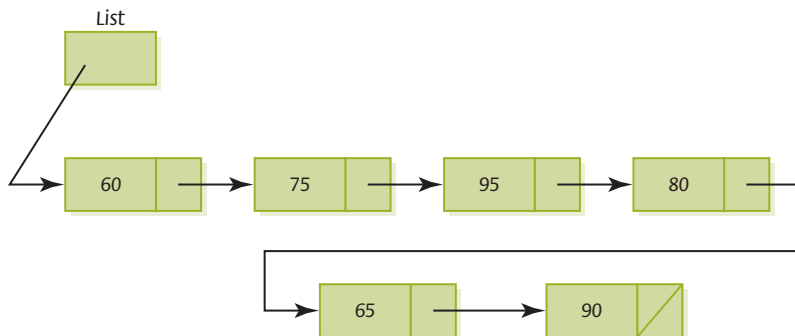


**FIGURE 8.1** An unsorted list of integers

A list may also be visualized as a **linked structure**. A linked structure is based on the concept of a node. A node consists of two pieces of information: the user's data and a link or pointer that indicates where to find the next node. The end of the list is a link that contains null, which is indicated by a '/'. See [FIGURE 8.2](#).

Unordered lists are those for which order is unimportant. Items are just haphazardly put into them. Sorted lists are those where there is a semantic relationship between items in the list. All items except the first come before the next item in this kind of list under some ordering relationship. All items except the last come after the one before it under the same relationship. [FIGURES 8.3](#) and [8.4](#) visualize the array-based and linked versions of a sorted list.

**Linked structure** An implementation of a container where the items are stored together with information on where the next item can be found



**FIGURE 8.2** An unsorted linked list

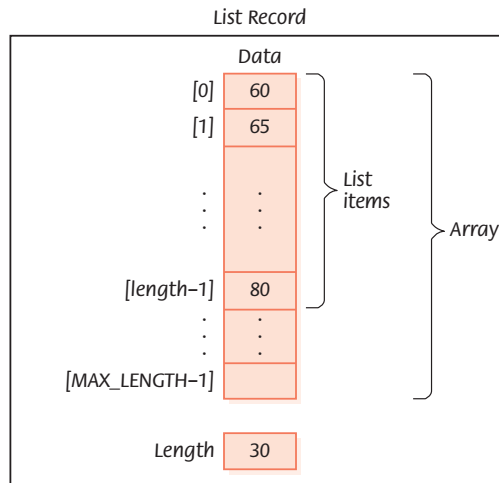


FIGURE 8.3 A sorted list of integers

Here is an algorithm that reads values from a file and puts them into a list. The list is then printed.

© Artur Debat/Getty Images, © Alan Dyer/Stocktrek Images/Getty Images

```

WHILE (more data)
 Read value
 Insert(myList, value)
Reset(myList)
Write "Items in the list are "
WHILE (MoreItems(myList))
 GetNext(myList, nextItem)
 Write nextItem, "

```

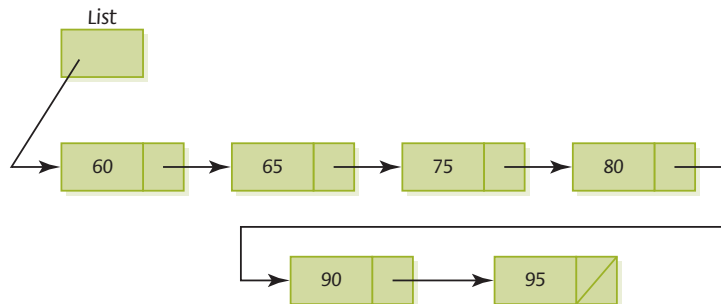


FIGURE 8.4 A sorted linked list

We use *Reset*, *MoreItems*, and *GetNext* to iterate through the list, returning each item in sequence. If the list is unsorted, the items will be printed in the order in which they are inserted. If the list is sorted, the items will be printed in sorted order. This algorithm works regardless of the implementation of the list.

## 8.5 Trees

Abstract structures such as lists, stacks, and queues are linear in nature. Only one relationship in the data is being modeled. Items are next to each other in a list or are next to each other in terms of time in a stack or queue. Depicting more complex relationships requires more complex structures. Take, for example, an animal hierarchy. General classification occurs at higher levels and the labels get more specific as you move down. Each node could have many below it (FIGURE 8.5).

Such hierarchical structures are called *trees*, and there is a rich mathematical theory relating to them. In computing, however, we often restrict our discussion to binary trees. In binary trees, each node in the tree can have no more than two children.

### Binary Trees

A **binary tree** is a tree in which each node is capable of having at most two successor nodes, called *children*. Each of the children, being nodes in the binary tree, can also have up to two child nodes, and these children can also have up to two children, and so on, giving the tree its branching structure. The beginning of the tree is a unique starting node called the **root**, which is not the child of any node. FIGURE 8.6 shows a binary tree containing integer values.

Each node in the tree may have zero, one, or two children. The node to the left of a node, if it exists, is called its *left child*. For example, in Figure 8.6, the left child of the root node contains the value 2. The node to the right of a node, if it exists, is its *right child*. The right child of the root node in Figure 8.6 contains the value 3. If a node has only one child,

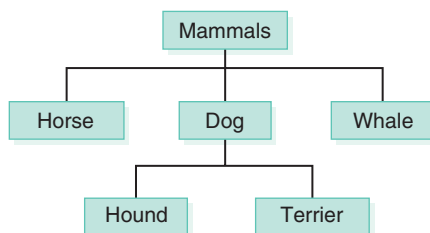


FIGURE 8.5 An animal hierarchy forms a tree

### Peer-to-Peer hardware funding

Open-source hardware is hardware that keeps its designs available in a way similar to the open source in software.

Two open-source hardware advocates, Justin Huynh and Matt Stack, started the Open Source Hardware Bank (OSHB), using money pooled from other open-source advocates, to support open-source hardware projects. The peer-to-peer lenders are promised 5% to 15% if the project is successful.

**Binary tree** An abstract composite structure with a unique starting node called the *root*, in which each node is capable of having two child nodes and in which a unique path exists from the root to every other node

**Root** The unique starting node in a tree

© Artur Debat/Getty Images; © Alan Dyer/Stocktrek Images/Getty Images

## John von Neumann<sup>2</sup>

John von Neumann was a brilliant mathematician, physicist, logician, and computer scientist. Legends have been passed down about his astonishing memory and the phenomenal speed at which von Neumann solved problems. He used his talents not only for furthering his mathematical theories, but also for memorizing entire books and reciting them years after he had read them.

John von Neumann was born in Hungary in 1903, the oldest son of a wealthy Jewish banker. He was able to divide 8-digit numbers in his head by the age of 6. He entered high school by the time he was 11, and it wasn't long before his math teachers recommended he be tutored by university professors. He received his diploma in chemical engineering from the Technische Hochschule in Zürich in 1926. In the same year, he received his doctorate in mathematics from the University of Budapest, with a thesis on set theory.

von Neumann came to the United States in the early 1930s to teach at Princeton, while still keeping his academic posts in Germany. He resigned the German posts when the Nazis came to power; he was not, however, a political refugee as so many were at that time. While at Princeton, he worked with the talented and as-yet-unknown British student Alan Turing. He continued his brilliant mathematical career, becoming editor of *Annals of Mathematics* and co-editor of *Compositio Mathematica*. During World War II, von Neumann was hired as a consultant for the U.S. Armed Forces and related civilian agencies because of his knowledge of hydrodynamics. He was also called upon to participate in the construction of the atomic bomb in 1943. It

was not surprising that, following this work, President Eisenhower appointed him to the Atomic Energy Commission in 1955.

Even though bombs and their performance fascinated von Neumann for many years, a fortuitous meeting in 1944 with Herbert Goldstine, a pioneer who developed one of the first operational electronic digital computers, introduced the mathematician to computers. von Neumann started working on the stored program concept and concluded that internally storing a program eliminated the hours of tedious labor required to reprogram computers (in those days). He also developed a new computer architecture to perform this storage task. Today's computers are often referred to as “von Neumann machines” because the architectural principles he described have proven so tremendously successful. Computers have changed a lot over the past 50 years, but the basic architecture designed by von Neumann has persisted.

During the 1950s, von Neumann was a consultant for IBM, where he reviewed proposed and ongoing advanced technology projects. One such project was John Backus's FORTRAN, which von Neumann reportedly questioned, asking why anyone would want more than one machine language.

In 1957, von Neumann died of bone cancer in Washington, D.C., at the age of 54. Perhaps his work with the atomic bomb resulted in the bone cancer that caused the death of one of the most brilliant and interesting minds of the twentieth century.



Courtesy of the U.S. Department of Energy

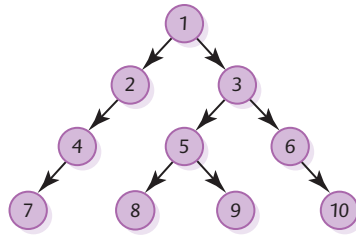


FIGURE 8.6 A binary tree

the child could be on either side, but it is always on one particular side. In Figure 8.6, the root node is the parent of the nodes containing 2 and 3. If a node in the tree has no children, it is called a *leaf*. In Figure 8.6, the nodes containing 7, 8, 9, and 10 are **leaf nodes**.

In addition to specifying that a node may have up to two children, the definition of a binary tree states that a unique path exists from the root to every other node. In other words, every node (except the root) has a unique (single) parent.

Each of the root node's children is itself the root of a smaller binary tree, or subtree. In Figure 8.6, the root node's left child, containing 2, is the root of its left subtree, while the right child, containing 3, is the root of its right subtree. In fact, any node in the tree can be considered the root node of a subtree. The subtree whose root node has the value 2 also includes the nodes with values 4 and 7. These nodes are the descendants of the node containing 2. The descendants of the node containing 3 are the nodes with the values 5, 6, 8, 9, and 10. A node is the ancestor of another node if it is the parent of the node or the parent of some other ancestor of that node. (Yes, this is a recursive definition.) In Figure 8.6, the ancestors of the node with the value 9 are the nodes containing 5, 3, and 1. Obviously, the root of the tree is the ancestor of every other node in the tree.

## Binary Search Trees

A tree is analogous to an unordered list. To find an item in the tree, we must examine every node until either we find the one we want or we discover that it isn't in the tree. A binary *search* tree is like a sorted list in that there is a semantic ordering in the nodes.

A binary search tree has the shape property of a binary tree; that is, a node in a binary search tree can have zero, one, or two children. In addition, a binary search tree has a semantic property that characterizes the values in the nodes in the tree: The value in any node is greater than

**Leaf node** A tree node that has no children

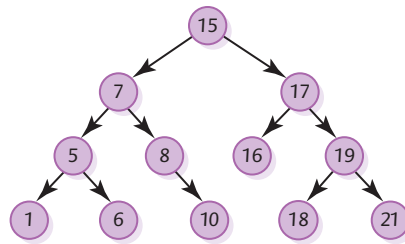


FIGURE 8.7 A binary search tree

the value in any node in its left subtree and less than the value in any node in its right subtree. See [FIGURE 8.7](#).

### Searching a Binary Search Tree

Let's search for the value 18 in the tree shown in Figure 8.7. We compare 18 with 15, the value in the root node. Because 18 is greater than 15, we know that if 18 is in the tree it will be in the right subtree of the root. Note the similarity of this approach to our binary search of a linear structure (discussed in Chapter 7). As in the linear structure, we eliminate a large portion of the data with one comparison.

Next we compare 18 with 17, the value in the root of the right subtree. Because 18 is greater than 17, we know that if 18 is in the tree, it will be in the right subtree of the root. We compare 18 with 19, the value in the root of the right subtree. Because 18 is less than 19, we know that if 18 is in the tree, it will be in the left subtree of the root. We compare 18 with 18, the value in the root of the left subtree, and we have a match.

Now let's look at what happens when we search for a value that is not in the tree. Let's look for 4 in Figure 8.7. We compare 4 with 15. Because 4 is less than 15, if 4 is in the tree, it will be in the left subtree of the root. We compare 4 with 7, the value in the root of the left subtree. Because 4 is less than 7, if 4 is in the tree, it will be in 7's left subtree. We compare 4 with 5. Because 4 is less than 5, if 4 is in the tree, it will be in 5's left subtree. We compare 4 with 1. Because 4 is greater than 1, if 4 is in the tree, it will be in 1's right subtree. But 1's left subtree is empty, so we know that 4 is not in the tree.

In looking at the algorithms that work with trees, we use the following conventions: If *current* points to a node, *info(current)* refers to the user's data in the node, *left(current)* points to the root of the left subtree of *current*, and *right(current)* points to the root of the right subtree of *current*. *null* is a special value that means that the pointer points to nothing. Thus, if a pointer contains *null*, the subtree is empty.

## ?

#### Terrorist detection software

Social network analysis provides a way of modeling how people interact using a branch of mathematics called *graph theory*. Graph theory maps people as *nodes* and their relationships as *links*. Today, some researchers are using this approach to build software models of terrorist networks. When the software is given data on the number of members of a network who have been apprehended, it can estimate the probability that the network has been disrupted. This estimate may be better than one provided by human judgment.

Using this notation, we can now write the search algorithm. We start at the root of the tree and move to the root of successive subtrees until we either find the item we are looking for or we find an empty subtree. The item to be searched for and the root of the tree (subtree) are parameters—the information that the subalgorithm needs to execute.

© Artur Debat/Getty Images; © Alan Dyer/Stocktrek Images/Getty Images

### IsThere(tree, item)

```

IF (tree is null)
 RETURN FALSE
ELSE
 IF (item equals info(tree))
 RETURN TRUE
 ELSE
 IF (item < info(tree))
 IsThere(left(tree), item)
 ELSE
 IsThere(right(tree), item)

```

With each comparison, either we find the item or we cut the tree in half by moving to search in the left subtree or the right subtree. In half? Well, not exactly. The shape of a binary tree is not always well balanced. Clearly, the efficiency of a search in a binary search tree is directly related to the shape of the tree. How does the tree get its shape? The shape of the tree is determined by the order in which items are entered into the tree. Look at **FIGURE 8.8**. In part (a), the four-level tree is comparatively balanced. The nodes could have been entered in several different orders to get this tree. By comparison, the ten-level tree in part (b) could only have come from the values being entered in order.

## Building a Binary Search Tree

How do we build a binary search tree? One clue lies in the search algorithm we just used. If we follow the search path and do not find the item, we end up at the place where the item would be if it were in the tree. Let's now build a binary search tree using the following strings: john, phil, lila, kate, becca, judy, june, mari, jim, sue.



## Chapter 8: Abstract Data Types and Subprograms

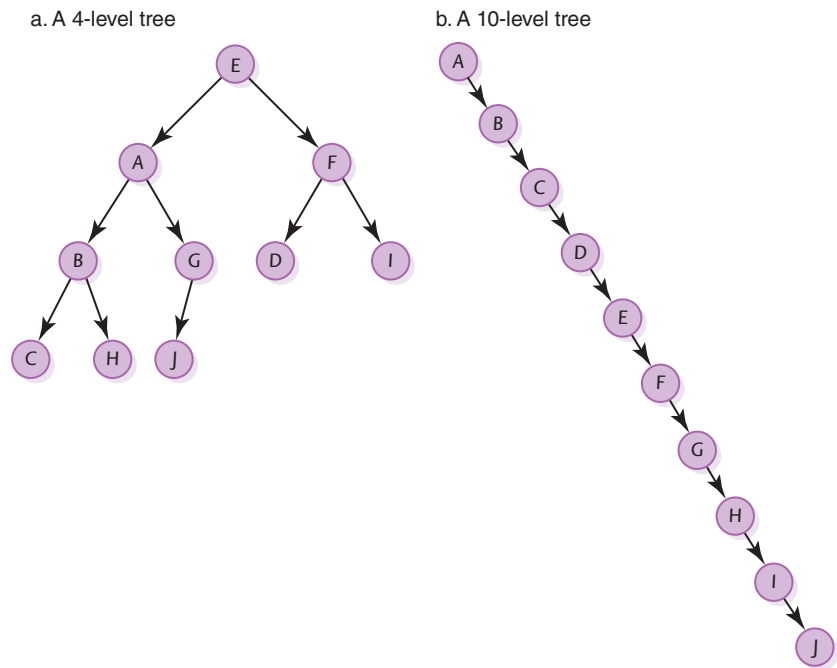
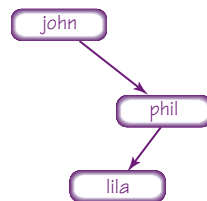
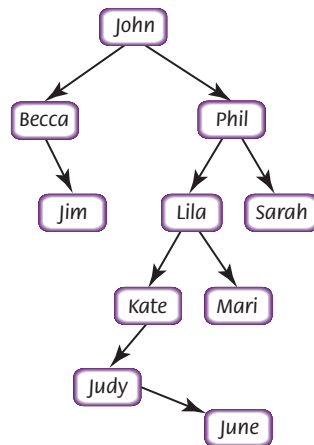


FIGURE 8.8 Two variations of a binary search tree

Because *john* is the first value to be inserted, it goes into the root. The second value, *phil*, is greater than *john*, so it goes into the root of the right subtree. *lila* is greater than *john* but less than *phil*, so *lila* goes into the root of the left subtree of *phil*. The tree now looks like this:



*kate* is greater than *john* but less than *phil* and *lila*, so *kate* goes into the root of the left subtree of *lila*. *becca* is less than *john*, so *becca* goes into the root of the left subtree of *john*. *judy* is greater than *john* but less than *phil*, *lila*, and *kate*, so *judy* goes into the root of the left subtree of *kate*. We follow the same path for *june* as we did for *judy*. *june* is greater than *judy*, so *june* goes into the root of the right subtree of *judy*. *mari* becomes the root of *lila*'s right subtree; *jim* becomes the root of the right



**FIGURE 8.9** A binary search tree built from strings

subtree of *becca*; and *sue* becomes the root of the right subtree of *phil*. The final tree is shown in [FIGURE 8.9](#).

© Artur Debat/Getty Images; © Alan Dyer/Stocktrek Images/Getty Images

### Insert(tree, item)

IF (tree is null)

Put item in tree

ELSE

IF (item < info(tree))

Insert(left(tree), item)

ELSE

Insert(right(tree), item)

**TABLE 8.1** shows a trace of inserting *nell* into the tree shown in Figure 8.9. We use the contents of the *info* part of the node within parentheses to indicate the pointer to the subtree with that value as a root.

Although *Put item in tree* is abstract, we do not expand it. We would need to know more about the actual implementation of the tree to do so.

## TABLE

8.1 Trace of Inserting *nell* into the Tree in Figure 8.9

| Call to Insert       | 1 <sup>st</sup> IF Statement | 2 <sup>nd</sup> IF Statement | Action or Call                                    |
|----------------------|------------------------------|------------------------------|---------------------------------------------------|
| Insert((john), nell) | (john)! = null               | nell > john                  | Insert into the right subtree                     |
| Insert((phil), nell) | (phil)! = null               | nell < phil                  | Insert into the left subtree                      |
| Insert((lila), nell) | (lila)! = null               | nell > lila                  | Insert into the right subtree                     |
| Insert((mari), nell) | (mari)! = null               | nell > mari                  | Insert into the right subtree                     |
| Insert((null), nell) | null = null                  |                              | Store nell as root of the right subtree of (mari) |

## ?

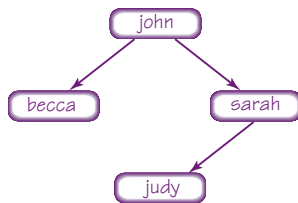
## False alarm

In 2005, a glitch at a Las Vegas radio station alerted cable companies, radio, and TV stations in five counties to a national crisis that didn't exist. That error occurred when a radio station tried to send out a message cancelling an earlier AMBER Alert and instead transmitted an EAN, or emergency action notification—a special code reserved for the president of the United States to use in the event of a nuclear war or similar extreme national emergency.

## Printing the Data in a Binary Search Tree

To print the value in the root, we must first print all the values in its left subtree, which by definition are smaller than the value in the root. Once we print the value in the root, we must print all the values in the root's right subtree, which by definition are greater than the value in the root. We are then finished. Finished? But what about the values in the left and right subtrees? How do we print them? Why, the same way, of course. They are, after all, just binary search trees.

This algorithm sounds too easy. That's the beauty of recursive algorithms: They are often short and elegant (although sometimes they take some thought to trace). Let's write and trace this algorithm using the tree shown below the algorithm. We number the calls in our trace because there are two recursive calls. See [TABLE 8.2](#).

Print(tree)

```

IF (tree is NOT null)
 Print(left(tree)) // Recursive call R1
 Write info(tree)
 Print(right(tree)) // Recursive call R2

```

TABLE

## 8.2 Trace of Printing the Previous Tree

| Calls          | Which Call | IF Statement    | Action or Call                   |
|----------------|------------|-----------------|----------------------------------|
| Print((john))  | R1         | (john)! = null  | Print(left(john))                |
| Print((becca)) | R1         | (becca)! = null | Print(left(becca))               |
| Print(null)    | R1         | null = null     | Return                           |
| Print((becca)) |            |                 | Print becca, Print(right(becca)) |
| Print(null)    | R2         | null = null     | Return, Return                   |
| Print((john))  |            |                 | Print john, Print(right(john))   |
| Print((sarah)) | R2         | (sarah)! = null | Print(left(sarah))               |
| Print((judy))  | R1         | (judy)! = null  | Print(left(judy))                |
| Print(null)    | R1         | null = null     | Return                           |
| Print((judy))  |            |                 | Print judy, Print(right(judy))   |
| Print(null)    | R2         | null = null     | Return, Return                   |
| Print((sarah)) |            |                 | Print sarah, Print(right(sarah)) |
| Print(null)    | R2         | null = null     | Return, Return                   |

This algorithm prints the items in the binary search tree in ascending value order. Other traversals of the tree print the items in other orders. We explore them in the exercises.

## Other Operations

At this point you may have realized that a binary search tree is an object with the same functionality as a list. The characteristic that separates a binary search tree from a simple list is the efficiency of the operations; the other behaviors are the same. We have not shown the *Remove* algorithm, because it is too complex for this text. We have also ignored the concept *length*, which must accompany the tree if it is to be used to implement a list. Rather than keep track of the number of items in the tree as we build it, let's write an algorithm that counts the number of nodes in the tree.

How many nodes are in an empty tree? Zero. How many nodes are in any tree? There are one plus the number of nodes in the left subtree

and the number of nodes in the right subtree. This definition leads to a recursive definition of the *Length* operation:

### Length(tree)

IF (tree is null)

    RETURN 0

ELSE

    RETURN Length(left(tree)) + Length(right(tree)) + 1

© Artur Debat/Getty Images, © Alan Dyer/Stocktrek Images/Getty Images

## 8.6 Graphs

Trees are a useful way to represent relationships in which a hierarchy exists. That is, a node is pointed to by at most one other node (its parent). If we remove the restriction that each node may have only one parent node, we have a data structure called a **graph**. A graph is made up of a set of nodes called **vertices** and a set of lines called **edges** (or **arcs**) that connect the nodes.

The vertices in the graph represent objects, and the edges describe relationships among the vertices. For instance, if the graph is representing a map, the vertices might be the names of cities, and the edges that link the vertices could represent roads between pairs of cities. Because the roads that run between cities are two-way paths, the edges in this graph have no direction. Such a graph is called an **undirected graph**. However, if the edges that link the vertices represent flights from one city to another, the direction of each edge is important. The existence of a flight (edge) from Houston to Austin does not assure the existence of a flight from Austin to Houston. A graph whose edges are directed from one vertex to another is called a **directed graph** (or **digraph**). A weighted graph is one in which there are values attached to the edges in the graph.

Look at the graphs in [FIGURE 8.10](#). The relationships among siblings are undirected. For example, June is Sarah's sibling and Sarah is June's sibling; see [FIGURE 8.10\(a\)](#). The prerequisite chart in [FIGURE 8.10\(c\)](#) is directed: *Computer Science I* must come before *Computer Science II*. The flight schedule is both directed and weighted; see [FIGURE 8.10\(b\)](#). There is a flight from Dallas to Denver that covers a distance of 780 miles, but there is not a direct flight from Denver to Dallas.

**Graph** A data structure that consists of a set of nodes and a set of edges that relate the nodes to each other

**Vertex** A node in a graph

**Edge (arc)** A pair of vertices representing a connection between two nodes in a graph

**Undirected graph**  
A graph in which the edges have no direction

**Directed graph (digraph)** A graph in which each edge is directed from one vertex to another (or the same) vertex

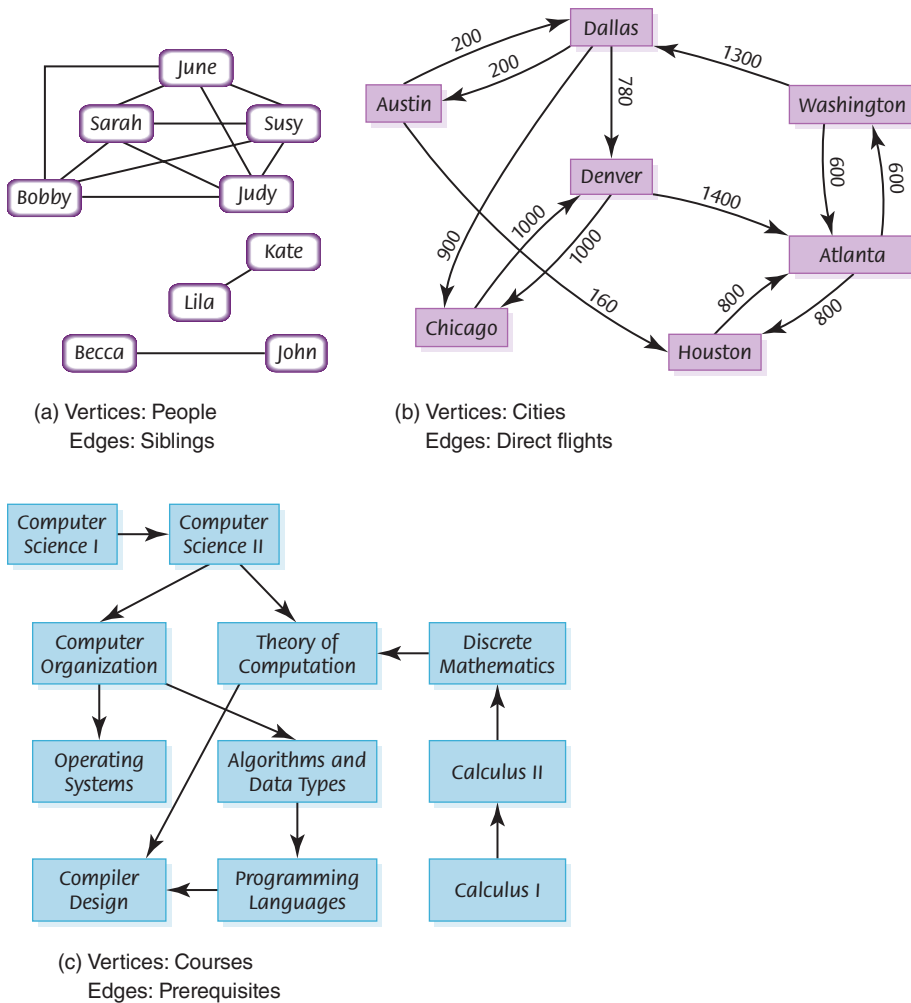


FIGURE 8.10 Examples of graphs

If two vertices are connected by an edge, we say they are **adjacent vertices**. In Figure 8.10(a), *June* is adjacent to *Bobby*, *Sarah*, *Judy*, and *Susy*. A **path** from one vertex to another consists of a sequence of vertices that connect them. For example, there is a path from *Austin* to *Dallas* to *Denver* to *Chicago*. There is not a path from *June* to *Lila*, *Kate*, *Becca*, or *John*.

Vertices represent whatever objects are being modeled: people, houses, cities, courses, concepts, and so on. The edges represent relationships between those objects. For example, people are related to other

#### Adjacent vertices

Two vertices that are connected by an edge

**Path** A sequence of vertices that connects two nodes in a graph

people, houses are on the same street, cities are linked by direct flights, courses have prerequisites, and concepts are derived from other concepts. (See Figure 8.10.) Mathematically, vertices are the undefined concept upon which graph theory rests. There is a great deal of formal mathematics associated with graphs, which is beyond the scope of this book.

## Creating a Graph

Lists, stacks, queues, and trees are all just holding containers. The user chooses which is most appropriate for a particular problem. There are no inherent semantics other than those built into the retrieval process: A stack returns the item that has been in the stack the least amount of time; a queue returns the item that has been in the queue the longest amount of time. Lists and trees return the information that is requested. A graph, in contrast, has algorithms defined upon it that actually solve classic problems. First we talk about building a graph; then we discuss problems that are solvable using a graph.

A lot of information is represented in a graph: the vertices, the edges, and the weights. Let's visualize the structure as a table using the flight connection data. The rows and columns in [TABLE 8.3](#) are labeled with the city names. A zero in a cell indicates that there is no flight from the row city to the column city. The values in the table represent the number of miles from the row city to the column city.

TABLE

## 8.3

## Data for the Flight Graph

© Artur Debat/Getty Images, © Alan Dyer/Stocktrek Images/Getty Images

|            | Atlanta | Austin | Chicago | Dallas | Denver | Houston | Washington |
|------------|---------|--------|---------|--------|--------|---------|------------|
| Atlanta    | 0       | 0      | 0       | 0      | 0      | 800     | 600        |
| Austin     | 0       | 0      | 0       | 200    | 0      | 160     | 0          |
| Chicago    | 0       | 0      | 0       | 0      | 1000   | 0       | 0          |
| Dallas     | 0       | 200    | 900     | 0      | 780    | 0       | 0          |
| Denver     | 1400    | 0      | 1000    | 0      | 0      | 0       | 0          |
| Houston    | 800     | 0      | 0       | 0      | 0      | 0       | 0          |
| Washington | 600     | 0      | 0       | 1300   | 0      | 0       | 0          |

To build such a table we must have the following operations:

- Add a vertex to the table
- Add an edge to the table
- Add a weight to the table

We find a position in the table by stating the row name and the column name. That is, (Atlanta, Houston) has a flight of 800 miles. (Houston, Austin) contains a zero, so there is no direct flight from Houston to Austin.

## Graph Algorithms

There are three classic searching algorithms defined on a graph, each of which answers a different question.

- Can I get from City X to City Y on my favorite airline?
- How can I fly from City X to City Y with the fewest number of stops?
- What is the shortest flight (in miles) from City X to City Y?

The answers to these three questions involve a depth-first search, a breadth-first search, and a single-source shortest-path search.

### Depth-First Search

Can I get from City X to City Y on my favorite airline? Given a starting vertex and an ending vertex, let's develop an algorithm that finds a path from *startVertex* to *endVertex*. We need a systematic way to keep track of the cities as we investigate them. Let's use a stack to store vertices as we encounter them in trying to find a path between the two vertices. With a depth-first search, we examine the first vertex that is adjacent with *startVertex*; if this is *endVertex*, the search is over. Otherwise, we examine all the vertices that can be reached in one step from this first vertex.

Meanwhile, we need to store the other vertices that are adjacent with *startVertex* to use later if we need them. If a path does not exist from the first vertex adjacent with *startVertex*, we come back and try the second vertex, third vertex, and so on. Because we want to travel as far as we can down one path, backtracking if *endVertex* is not found, a stack is the appropriate structure for storing the vertices.



?

## Who needs banks?

A lending club is an online financial community that brings together borrowers and investors. Investment clubs have existed for a long time, but now the Internet enables people who have never met to form clubs. Lending clubs invest in real estate, software companies, and small businesses. Lending Club, the largest such club in the United States, had its initial public offering (IPO) in 2014, raising \$1 billion. Along with PayPal, lending clubs are attempting to bring down borrowing costs for Main Street businesses that don't qualify for bank loans.<sup>3</sup>

© Artur Debat/Getty Images, © Alan Dyer/Stocktrek Images/Getty Images

Depth First Search(startVertex, endVertex)

```

Set found to FALSE
Push(myStack, startVertex)
WHILE (NOT IsEmpty(myStack) AND NOT found)
 Pop(myStack, tempVertex)
 IF (tempVertex equals endVertex)
 Write endVertex
 Set found to TRUE
 ELSE IF (tempVertex not visited)
 Write tempVertex
 Push all unvisited vertices adjacent with tempVertex
 Mark tempVertex as visited
IF (found)
 Write "Path has been printed"
ELSE
 Write "Path does not exist"

```

We mark a vertex as visited once we have put all its adjacent vertices on the stack. If we process a vertex that has already been visited, we keep putting the same vertices on the stack over and over again. Then the algorithm isn't an algorithm at all because it might never end. So we must not process a vertex more than once.

Let's apply this algorithm to the sample airline-route graph in Figure 8.10(b). We want to fly from Austin to Washington. We initialize our search by pushing our starting city onto the stack (FIGURE 8.11(a)). At the beginning of the loop, we pop the current city, Austin, from the stack. The places we can reach directly from Austin are Dallas and Houston; we

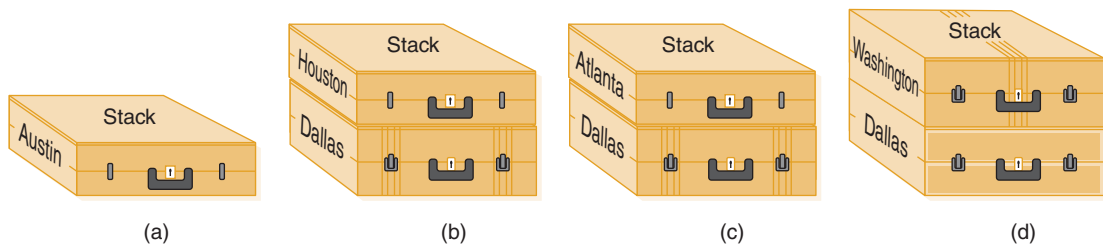


FIGURE 8.11 Using a stack to store the routes

push both these vertices onto the stack ( [FIGURE 8.11\(b\)](#) ). At the beginning of the second iteration, we pop the top vertex from the stack—*Houston*. *Houston* is not our destination, so we resume our search from there. There is only one flight out of *Houston*, to *Atlanta*; we push *Atlanta* onto the stack ( [FIGURE 8.11\(c\)](#) ). Again we pop the top vertex from the stack. *Atlanta* is not our destination, so we continue searching from there. *Atlanta* has flights to two cities: *Houston* and *Washington*.

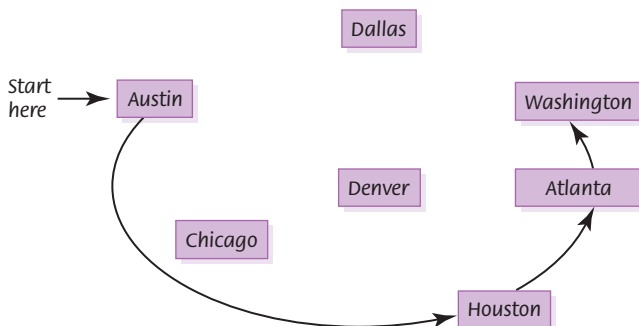
But we just came from *Houston*! We don't want to fly back to cities that we have already visited; this could cause an infinite loop. But we have already taken care of this problem: *Houston* has already been visited, so we continue without putting anything on the stack. The second adjacent vertex, *Washington*, has not been visited, so we push it onto the stack ( [FIGURE 8.11\(d\)](#) ). Again we pop the top vertex from the stack. *Washington* is our destination, so the search is complete.

[FIGURE 8.12](#) shows the result of asking if we can reach *Washington* from *Austin*.

This search is called a *depth-first search* because we go to the deepest branch, examining all the paths beginning at *Houston* before we come back to search from *Dallas*. When you have to backtrack, you take the branch closest to where you dead-ended. That is, you go as far as you can down one path before you take alternative choices at earlier branches.

## Breadth-First Search

How can you get from City X to City Y with the fewest number of stops? The breadth-first traversal answers this question. When we come to a dead end in a depth-first search, we back up as *little* as possible. We try another route from the most recent vertex—the route on top of our stack. In a breadth-first search, we want to back up as *far* as possible to find a route originating from the earliest vertices. The stack is not the right structure for finding an early route. It keeps track of things in the order



**FIGURE 8.12** The depth-first search

opposite of their occurrence—that is, the latest route is on top. To keep track of things in the order in which they happen, we use a queue. The route at the front of the queue is a route from an earlier vertex; the route at the back of the queue is from a later vertex. Thus, if we substitute a queue for a stack, we get the answer to our question.

© Artur Debat/Getty Images, © Alan Dyer/Stocktrek Images/Getty Images

### Breadth-First Search(startVertex, endVertex)

```

Set found to FALSE
Enqueue(myQueue, startVertex)
WHILE (NOT isEmpty(myQueue) AND NOT found)
 Dequeue(myQueue, tempVertex)
 IF (tempVertex equals endVertex)
 Write endVertex
 Set found to TRUE
 ELSE IF (tempVertex not visited)
 Write tempVertex
 Enqueue all unvisited vertices adjacent with tempVertex
 Mark tempVertex as visited
IF (found)
 Write "Path has been printed"
ELSE
 Write "Path does not exist"

```

Let's apply this algorithm to the same airline-route graph in Figure 8.10(b). Which path gives us the route from Austin to Washington with the fewest stops? Austin is in the queue to start the process (FIGURE 8.13(a)). We dequeue Austin and enqueue all the cities that can be reached directly from Austin: Dallas and Houston (FIGURE 8.13(b)). Then we dequeue the front queue element. Dallas is not the destination we seek, so we enqueue all the adjacent cities that have not yet been visited: Chicago and Denver (FIGURE 8.13(c)). (Austin has been visited already, so it is not enqueued.) Again we dequeue the front element from the queue. This element is the other "one-stop" city—Houston. Houston is not the desired destination, so we continue the search. There is only one flight out of Houston, and it is to Atlanta. Because we haven't visited Atlanta before, it is enqueued (FIGURE 8.13(d)).

Now we know that we cannot reach Washington with one stop, so we start examining the two-stop connections. We dequeue Chicago; this is not our destination, so we put its adjacent city, Denver, into the queue

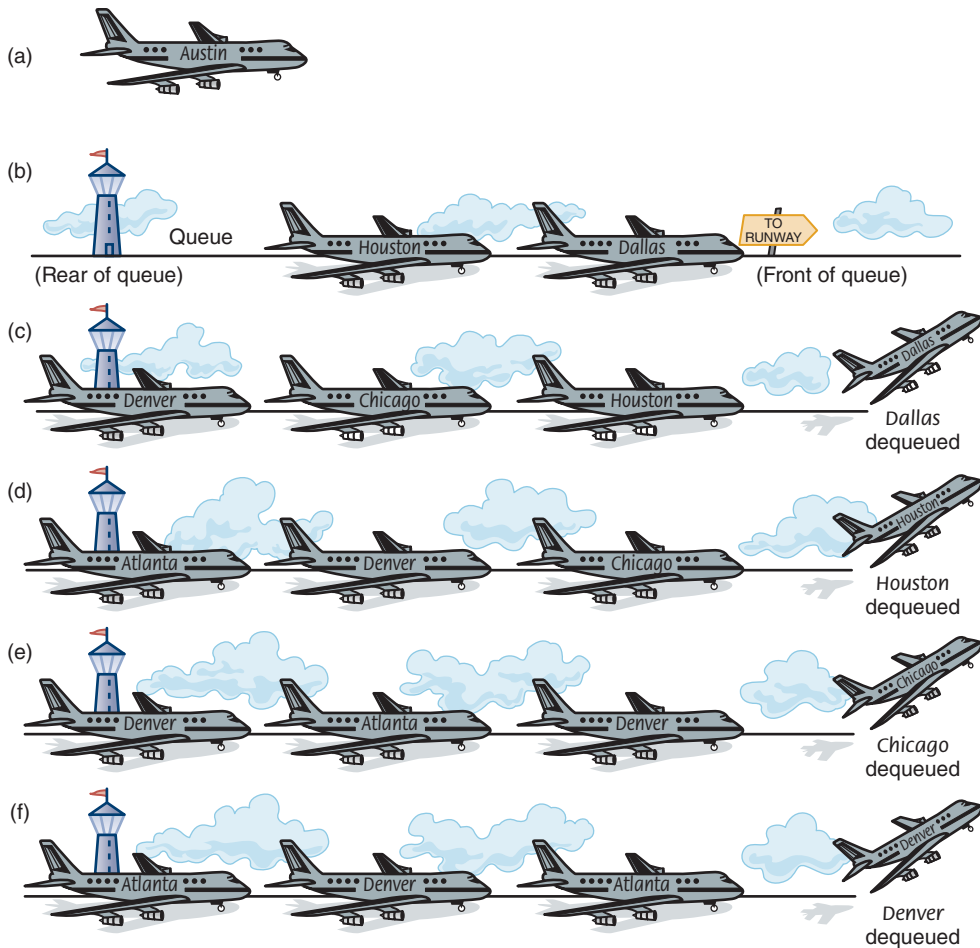


FIGURE 8.13 Using a queue to store the routes

(FIGURE 8.13(e)). Now this is an interesting situation: *Denver* is in the queue twice. We have put *Denver* into the queue in one step and removed its previous entry at the next step. *Denver* is not our destination, so we put its adjacent cities that haven't been visited (only *Atlanta*) into the queue (FIGURE 8.13(f)). This processing continues until *Washington* is put into the queue (from *Atlanta*) and is finally dequeued. We have found the desired city, and the search is complete (FIGURE 8.14).

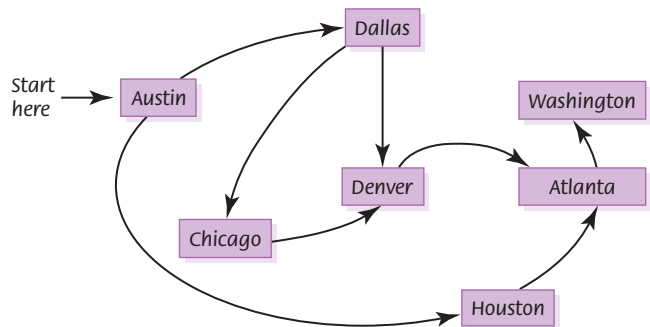


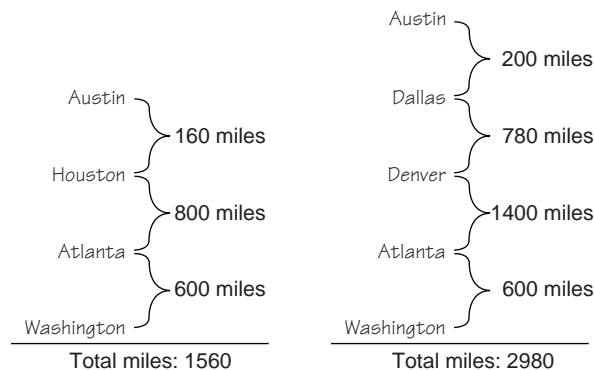
FIGURE 8.14 The breadth-first search

## Chapter 8: Abstract Data Types and Subprograms

As you can see from these two algorithms, a depth-first search goes as far down a path from *startVertex* as it can before looking for a path beginning at the second vertex adjacent with *startVertex*. In contrast, a breadth-first search examines all of the vertices adjacent with *startVertex* before looking at those adjacent with these vertices.

### Single-Source Shortest-Path Search

What is the shortest flight (in miles) from *Austin* to some other city? We know from the two search operations just discussed that there may be multiple paths from one vertex to another. Suppose we want to find the *shortest path* from *Austin* to each of the other cities that your favorite airline serves. By “shortest path,” we mean the path whose edge values (weights), when added together, have the smallest sum. Consider the following two paths from *Austin* to *Washington*:



Clearly the first path is preferable, unless you want to collect frequent-flyer miles.

Let’s develop an algorithm that displays the shortest path from a designated starting city to *every other city* in the graph—this time we are not searching for a path between a starting city and an ending city. As in the two graph searches described earlier, we need an auxiliary structure for storing cities that we process later. By retrieving the city that was most recently put into the structure, the depth-first search tries to keep going “forward.” It tries a one-flight solution, then a two-flight solution, then a three-flight solution, and so on. It backtracks to a fewer-flight solution only when it reaches a dead end. By retrieving the city that had been in the structure the longest time, the breadth-first search tries all one-flight solutions, then all two-flight solutions, and so on. The breadth-first search finds a path with a minimum number of flights.

Of course, the minimum *number* of flights does not necessarily mean the minimum *total distance*. Unlike the depth-first and breadth-first searches, the shortest-path traversal must account for the number of miles (edge weights) between cities in its search. We want to retrieve the vertex that is *closest* to the current vertex—that is, the vertex connected with the minimum edge weight. In the abstract container called a *priority queue*, the item that is retrieved is the item in the queue with the highest priority. If we let miles be the priority, we can enqueue items made up of a record that contains two vertices and the distance between them.

This algorithm is far more complex than we have seen before, so we stop at this point. However, the mathematically adventurous reader may continue to pursue this solution.

## 8.7 Subprograms

When we examined recursion, we introduced the concept of a named subalgorithm. Here we look at these in the nonrecursive context and discuss how we pass information back and forth between algorithm and subalgorithm. Because we are talking about actual language constructs, we call these structures *subprograms* rather than *subalgorithms*.

Many subprograms are available as part of a high-level language or as part of the library that comes with the language. For example, mathematical problems often need to calculate trigonometric functions. Subprograms that calculate these values are available in most high-level languages in one way or another. When a program needs to calculate one of these values, the programmer looks up the name of the subprogram that calculates the value and just calls the subprogram to perform the calculation.

If one of these subprograms needs to have information passed to it, the calling unit sends over the values for the subprogram to use. For example, the following two statements set  $x$  to  $m$  times the sine function of  $t$  and  $y$  to the absolute value of  $z$ . The sine function and the absolute value function are built into many languages. The information sent to the sine function is  $t$ ; the information sent to the absolute value function is  $z$ . Both of these functions are value-returning subprograms.

© Artur Debat/Getty Images, © Alan Dyer/Stocktrek Images/Getty Images

```
Set x to $m * \sin(t)$
```

```
Set y to $\text{abs}(z)$
```

## Chapter 8: Abstract Data Types and Subprograms

The same is true when you write your own subprograms. We now look at the mechanism used for passing information back and forth between the calling program and subprogram.

We have assumed these capabilities in the algorithms relating to the abstract data types we have examined. Take, for example, the following list algorithm:

```

WHILE (more data)
 Read value
 Insert(myList, value)
Reset(myList)
Write "Items in the list are "
WHILE (MoreItems(myList))
 GetNext(myList, nextItem)
 Write nextItem, '

```

*Insert* needs a list and a value to insert into it. *Reset* needs the list to reset. *MoreItems* needs the list to see if more items remain to be returned. *GetNext* needs the list as input and returns the next item in the list. This communication is done through the concept of a *parameter list*.

**Parameter list** A mechanism for communicating between two parts of a program

**Parameters** The identifiers listed in parentheses beside the subprogram name; sometimes called *formal parameters*

**Arguments** The identifiers listed in parentheses on the subprogram call; sometimes called *actual parameters*

## Parameter Passing

A **parameter list** is a list of the identifiers or values with which the subprogram is to work; it appears in parentheses beside the subprogram name. Because a subprogram is defined before it is called, it does not know with which variables from the calling unit it is to work. To solve this dilemma, we specify a list of variable names in parentheses beside the subprogram name. These identifiers are called **parameters**. When the subprogram is called, the calling unit lists the subprogram name, followed by a list of identifiers in parentheses. These identifiers are called **arguments**. The arguments represent actual variables in the calling unit with which the subprogram is to work.

You can think of a parameter as being a temporary identifier that is used within a subprogram. When a subprogram is called, the calling unit sends the names of the actual identifiers the subprogram is to use. The action

in the subprogram is defined using the parameters; the action is executed using the arguments. When the action takes place, the arguments are substituted one by one for the parameters. This substitution can be done in several ways, but the most common practice is by position. The first argument substitutes for the first parameter, the second argument substitutes for the second parameter, and so on.

We have promised not to look at too many implementations, but this one is easy. We can implement a list using an array and a length field. When we add an item to the list, we store it in the array (*values*) at the  $\text{length} - 1$  position and increment *length*. We bind the *values* and the *length* together into a record called *list*, which we pass to the subprogram that needs it.

© Artur Debat/Getty Images, © Alan Dyer/Stocktrek Images/Getty Images

```

Insert(list, item) // Subprogram definition
Set list.values[list.length - 1] to item
Set list.length to list.length + 1

Insert(myList, value) // Calling statement

```

*list* is the parameter and *mylist* is the argument. When *Insert* is executed, *myList* replaces *list*.

The substitution mechanism acts much like a message board. When a subprogram is called, a list of the arguments is given to the subprogram (put on the subprogram's message board). These arguments tell the subprogram where to find the values to use. When a parameter is used in the body of the subprogram, the subprogram accesses the argument through its relative position on the message board. That is, the subprogram looks for its first parameter in the first position on the message board and for its second parameter in the second position on the message board.

The number of arguments in the call must match the number of parameters in the subprogram heading. Because the arguments and parameters are matched by position, their names don't have to be the same. This is very helpful when a subprogram is called more than once, with different arguments in each call. Parameters passed in this fashion are often called *positional parameters*.

#### Hackers and crackers



The word *hacker* used to be complimentary, describing a programmer who could write very sophisticated programs almost overnight. Then the term came to refer to someone tinkering with programs with malicious intent.



## Value and Reference Parameters

### Value parameter

A parameter that expects a copy of its argument to be passed by the calling unit (put on the message board)

### Reference parameter

A parameter that expects the address of its argument to be passed by the calling unit (put on the message board)

There are two basic ways of passing parameters: by value and by reference (or address). If a parameter is a **value parameter**, the calling unit gives a *copy* of the argument to the subprogram. If a parameter is a **reference parameter**, the calling unit gives the *address* of the argument to the subprogram. This very fundamental difference means that a subprogram cannot change the content of a value argument because it receives only a copy of the argument. The subprogram can modify the copy, but the original variable will not be changed. In contrast, any argument passed by the calling unit to a reference parameter can be changed by the subprogram because the subprogram manipulates the actual variable, not a copy of it. In the previous example, the record being passed as *list* must be a reference parameter. If it is not, items would be inserted into the copy, not the original.

Think of the difference this way: To access a reference parameter, the subprogram accesses the contents of the *address* listed on the message board. To access a value parameter, the subprogram accesses the *contents* of the message board. Clearly, both the calling unit and the subprogram must know which parameter/argument is to be passed by value and which is to be passed by reference. Not all high-level languages allow both kinds of parameters, but those that do have some syntactic schemes to label parameters as *value* or *reference*.

Before we leave subprograms, let's look at an example that illustrates the difference between value and reference parameters. We have already written an algorithm that swaps the contents of two places in memory. Here is the solution without problem-dependent variable names:

### Swap(item1, item2)

```
Set temp to item2
Set item2 to item1
Set item1 to temp
```

Now suppose that the calling unit (the part of the program that wants the contents of the two places exchanged) calls *Swap* with *data1* and *data2* as parameters.

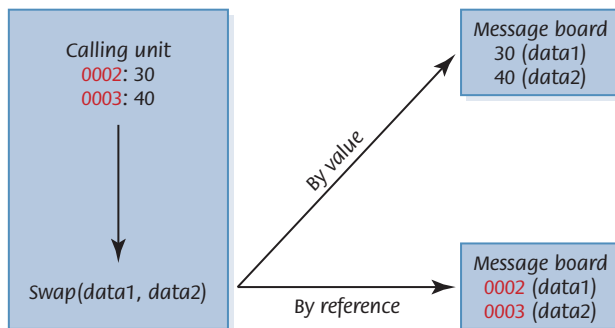
```
Swap(data1, data2)
```

Now let's say that *data1* is stored in location **0002** and *data2* is stored in location **0003**. These locations contain the values 30 and 40, respectively. **FIGURE 8.15** shows the content of the message board when the parameters are passed by value and passed by reference. When a parameter is a value parameter, the subprogram knows to manipulate the value on the message board. When a parameter is a reference parameter, the subprogram knows to manipulate the contents of the address on the message board. Should the parameters for subprogram *Swap* be value or reference parameters?

Before we leave the topic of subprograms and parameters, let's implement three more of the list subprograms: *getLength*, *IsThere*, and *Delete*. If the list items are not to be kept in sorted order, we can just put the first one in the *length* position and increment *length*. For this example, let's assume that only one copy of each item can be in the list.

```
getLength(list)
```

```
RETURN list.length
```



**FIGURE 8.15** The difference between value parameters and reference parameters

© Artur Debat/Getty Images, © Alan Dyer/Stocktrek Images/Getty Images

IsThere(list, item)

```

Set position to 0
WHILE (position < list.length AND list.values[position] != item)
 Set position to position + 1
RETURN position < list.length

```

`IsThere` is a subprogram that returns a value—in this case, a Boolean value. Thus it would be used in an expression such as

© Artur Debat/Getty Images, © Alan Dyer/Stocktrek Images/Getty Images

```

IF (IsThere(myList, item))
 Write item "is in the list"

```

This type of subprogram is called a *value-returning* subprogram. `Delete` and `Insert`, in contrast, do not return a specific value. However, they do return the changed list through its parameters. If we assume that the item to be deleted is in the list, the implementation is simple: When we find the item to be deleted, we just exchange it with the last item in the list and decrement length.

© Artur Debat/Getty Images, © Alan Dyer/Stocktrek Images/Getty Images

Delete(list, item)

```

Set position to 1
WHILE (list.values[position] != item)
 Set position to position + 1
Swap(list.values[list.length - 1], list.values[position])
Set list.length to list.length - 1

```

`IsThere` can be used to make sure that the item to be deleted is in the list.

© Artur Debat/Getty Images, © Alan Dyer/Stocktrek Images/Getty Images

```

IF (IsThere(myList, item))
 Delete(myList, item)

```

Value-returning subprograms include the RETURN statement followed by a value to be returned. Non-value-returning subprograms may have a RETURN statement, but it is unnecessary. To conclude this section, here is a code segment that reads values into the list and then deletes some values:

© Artur Debat/Getty Images, © Alan Dyer/Stocktrek Images/Getty Images

```

WHILE (more values)
 Read aValue
 IF (NOT IsThere(list, aValue))
 Insert(list, aValue)
Write "Input values to delete or "Quit" to quit"
Read aValue
IF (aValue != "Quit")
 IF (IsThere(list, aValue))
 Delete(list, aValue)

```

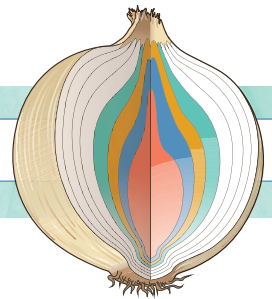
© Artur Debat/Getty Images, © Alan Dyer/Stocktrek Images/Getty Images

## SUMMARY

Lists, stacks, queues, trees, and graphs are all useful abstract composite structures. Each has its own defining property and the operations that guarantee that property. All of these abstract structures include operations to insert items and to remove items. Lists and trees also have operations to find items within the structure.

Lists and trees have the same properties: Items can be inserted, deleted, and retrieved. Items can be inserted in a stack, but the item removed and returned is the last item inserted into the stack—that is, the item that has been in the stack the shortest time. Items can be inserted into a queue, but the item removed and returned is the first item put into the queue—that is, the item that has been in the queue the longest time.

Lists, stack, queues, and trees are merely holding structures, but graphs are more complex. A wealth of mathematical algorithms can be applied to information in a graph. We examined three of these: the breadth-first search, the depth-first search, and the single-source shortest-path search.



Subprogram statements allow subalgorithms to be implemented independently. A subprogram may be value returning, in which case it is called by placing its name and arguments within an expression. Alternatively, a subprogram may be non-value-returning (void), in which case the subprogram name is used as a statement in the calling program. Data sent to and from subprograms are transmitted by the use of parameter lists. Parameters may be either reference or value parameters. An argument is passed to a value parameter by sending a copy of the argument to the subprogram. An argument is passed to a reference parameter by sending the address of the argument to the subprogram.



## ETHICAL ISSUES

### Workplace Monitoring<sup>4,5</sup>

The same privacy rights employees enjoy at home or in the marketplace *do not extend to the workplace*. Employees think conversations around the water cooler or on the phone at work are private. Usually, they're wrong. While they may know how to secure their Internet connections and phones at home, there is little they can do to ensure themselves the same privacy at work. An increasing number of employers are now using technology to monitor the workplace. Keystroke programs can gather and record every keystroke typed on a computer. Phones can be monitored and calls recorded. Some employers have installed cameras and audio devices that record conversations. There is even software that triggers a video scan of a cubicle if the keyboard has been idle for a certain length of time.

Recent surveys show that a majority of employers monitor their employees. A 2007 survey by the American Management Association's ePolicy Institute found that 65% of companies used software to block connections to inappropriate websites—a 27% increase since 2001. The number of employers that monitored the amount of time employees spent on the phone and tracked the numbers called also increased. Twenty-eight percent of employers have fired workers for email misuse. The realization that email creates a written business record that is the electronic equivalent of DNA evidence

has fueled the increase in workplace monitoring.

Advocates of these practices hail these results as good news. The computers, phones, and physical space belong to the employer, after all, and are provided to the employees for use in their jobs. After discovering workers surfing the Internet, downloading pornography, and using email to harass others or chat with friends, businesses realized that the same technology that allows such behavior can be used to monitor it. Employee Internet monitoring (EIM) has become a big business.

Although only two states (Delaware and Connecticut) require employers to notify employees of monitoring, most do. Still, privacy advocates say the trend has gone too far. Approximately 26% of the employers surveyed in 2005 had fired workers for misuse of the Internet, while 25% had fired employees for email misuse; 6% of employers had even fired workers for misuse of the office phone.

Opponents of the monitoring technologies point out that people are not machines. They must take breaks and feel that they have some control over their environment to be productive, satisfied employees. Knowing that personal phone calls, hallway conversations, and email are monitored injects feelings of resentment and apathy into the workplace. Who wants Big Brother for an office mate?



## ETHICAL ISSUES

### Workplace Monitoring<sup>4,5</sup> (CONTINUED)

Among the safeguards called for by privacy advocates are federal regulations, notification and training of employees on the various monitoring methods used, and limits of monitoring to cases where employers have cause to be suspicious of

an employee. However, lawmakers have chosen not to intervene. They point to the very real considerations of company security and the right of employers to monitor what goes on at the workplace.

© Artur Debat/Getty Images; © Alan Dyer/Stocktrek Images/Getty Images

## KEY TERMS

Abstract data type (ADT)  
 Adjacent vertices  
 Arguments  
 Binary tree  
 Containers  
 Data structure  
 Directed graph (digraph)  
 Edge (arc)  
 Graph  
 Leaf node

Linked structure  
 Parameter list  
 Parameters  
 Path  
 Reference parameter  
 Root  
 Undirected graph  
 Value parameter  
 Vertex

© Artur Debat/Getty Images; © Alan Dyer/Stocktrek Images/Getty Images

## EXERCISES

For Exercises 1–10, indicate which structure would be a more suitable choice for each of the following applications by marking them as follows:

- A. Stack
- B. Queue

- C. Tree
  - D. Binary search tree
  - E. Graph
1. A bank simulation of its teller operation to see how waiting times would be affected by adding another teller.

**EXERCISES (CONTINUED)**

2. A program to receive data that is to be saved and processed in the reverse order.
  3. An electronic address book, kept ordered by name.
  4. A word processor with a PF key that causes the preceding command to be redisplayed; every time the PF key is pressed, the program is to show the command that preceded the one currently displayed.
  5. A dictionary of words used by a spell checker to be built and maintained.
  6. A program to keep track of patients as they check into a medical clinic, assigning patients to doctors on a first-come, first-served basis.
  7. A program keeping track of where canned goods are located on a shelf.
  8. A program to keep track of the soccer teams in a city tournament.
  9. A program to keep track of family relationships.
  10. A program to maintain the routes in an airline.
- For Exercises 11–30, mark the answers true or false as follows:
- A. True
  - B. False
11. A binary search cannot be applied to a tree.
  12. A stack and a queue are different names for the same ADT.
  13. A stack displays FIFO behavior.
  14. A queue displays LIFO behavior.
  15. A leaf in a tree is a node with no children.
  16. A binary tree is a tree in which each node can have zero, one, or two children.
  17. *Binary search tree* is another name for a binary tree.
  18. The value in the right child of a node (if it exists) in a binary search tree will be greater than the value in the node itself.
  19. The value in the left child of a node (if it exists) in a binary search tree will be greater than the value in the node itself.
  20. In a graph, the vertices represent the items being modeled.
  21. Algorithms that use a list must know whether the list is array-based or linked.
  22. A list may be linear or nonlinear, depending on its implementation.
  23. The root of a tree is the node that has no ancestors.
  24. Binary search trees are ordered.
  25. On average, searching in a binary search tree is faster than searching in an array-based list.
  26. On average, searching in a binary search tree is faster than searching in a list.
  27. A binary search tree is always balanced.
  28. Given the number of nodes and the number of levels in a binary search tree, you can determine the relative efficiency of a search in the tree.
  29. Insertion in a binary search tree is always into a leaf node.
  30. A binary search tree is another implementation of a sorted list.



## EXERCISES (CONTINUED)

The following algorithm (used for Exercises 31–33) is a count-controlled loop going from 1 through 5. At each iteration, the loop counter is either printed or put on a stack, depending on the result of Boolean function `RanFun()`. (The behavior of `RanFun()` is immaterial.) At the end of the loop, the items on the stack are popped and printed. Because of the logical properties of a stack, this algorithm cannot print certain sequences of the values of the loop counter. You are given an output and asked if the algorithm could generate the output. Respond as follows:

- A. True
- B. False
- C. Not enough information

© Artur Debat/Getty Images; © Alan Dyer/Stocktrek Images/Getty Images

```

Set count to 0
WHILE (count < 5)
 Set count to count + 1
 IF (RanFun())
 Write count, ""
 ELSE
 Push(myStack, count)
WHILE (NOT IsEmpty(myStack))
 Pop(myStack, number)
 Write number, ""

```

- 31. The following output is possible using a stack: 1 3 5 2 4.
- 32. The following output is possible using a stack: 1 3 5 4 2.

- 33. The following output is possible using a stack: 1 3 5 1 3.

The following algorithm (used for Exercises 34–36) is a count-controlled loop going from 1 through 5. At each iteration, the loop counter is either printed or put on a queue, depending on the result of Boolean function `RanFun()`. (The behavior of `RanFun()` is immaterial.) At the end of the loop, the items on the queue are dequeued and printed. Because of the logical properties of a queue, this algorithm cannot print certain sequences of the values of the loop counter. You are given an output and asked if the algorithm could generate the output. Respond as follows:

- A. True
- B. False
- C. Not enough information

© Artur Debat/Getty Images; © Alan Dyer/Stocktrek Images/Getty Images

```

Set count to 0
WHILE (count < 5)
 Set count to count + 1
 IF (RanFun())
 Write count, ""
 ELSE
 Enqueue(myQueue, count)
WHILE (NOT IsEmpty(myQueue))
 Dequeue(myQueue, number)
 Write number, ""

```

- 34. The following output is possible using a queue: 1 3 5 2 4.

## EXERCISES (CONTINUED)

35. The following output is possible using a queue: 1 3 5 4 2.
36. The following output is possible using a queue: 1 3 5 1 3.

Exercises 37–50 are short-answer questions.

37. What is written by the following algorithm?
- ```

Push(myStack, 5)
Push(myStack, 4)
Push(myStack, 4)
Pop(myStack, item)
Pop(myStack, item)
Push(myStack, item)
WHILE (NOT isEmpty(myStack))
    Pop(myStack, item)
    Write item, ''

```
38. What is written by the following algorithm?
- ```

Enqueue(myQueue, 5)
Enqueue(myQueue, 4)
Enqueue(myQueue, 4)
Dequeue(myQueue, item)
Dequeue(myQueue, item)
Enqueue(myQueue, item)
WHILE (NOT isEmpty(myQueue))
 Dequeue(myQueue, item)
 Write item, ''

```
39. Write an algorithm that sets *bottom* equal to the last element in the stack, leaving the stack empty.
40. Write an algorithm that sets *bottom* equal to the last element in the stack, leaving the stack unchanged.
41. Write an algorithm to create a copy of *myStack*, leaving *myStack* unchanged.
42. Write an algorithm that sets *last* equal to the last element in a queue, leaving the queue empty.
43. Write an algorithm that sets *last* equal to the last element in a queue, leaving the queue unchanged.
44. Write an algorithm to create a copy of *myQueue*, leaving *myQueue* unchanged.
45. Write an algorithm *replace* that takes a stack and two items. If the first item is in the stack, replace it with the second item, leaving the rest of the stack unchanged.
46. Write an algorithm *replace* that takes a queue and two items. If the first item is in the queue, replace it with the second item, leaving the rest of the queue unchanged.
47. Draw the binary search tree whose elements are inserted in the following order:
- 50 72 96 107 26 12 11 9 2  
10 25 51 16 17 95
48. If *Print* is applied to the tree formed in Exercise 47, in which order would the elements be printed?
49. Examine the following algorithm and apply it to the tree formed in Exercise 47. In which order would the elements be printed?

## EXERCISES (CONTINUED)

© Artur Debat/Getty Images; © Alan Dyer/Stocktrek Images/Getty Images

Print2(tree)

```

IF (tree is NOT null)
 Print(right(tree)) // Recursive call R1
 Write info(tree)
 Print(left(tree)) // Recursive call R2

```

50. Examine the following algorithm and apply it to the tree formed in Exercise 47. In which order would the elements be printed?

© Artur Debat/Getty Images; © Alan Dyer/Stocktrek Images/Getty Images

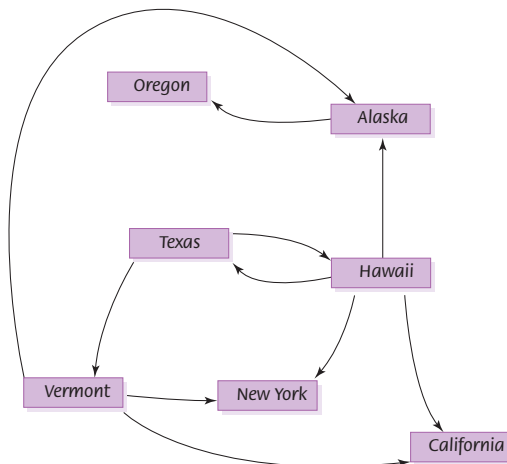
Print3(tree)

```

IF (tree is NOT null)
 Print(right(tree)) // Recursive call R1
 Print(left(tree)) // Recursive call R2
 Write info(tree)

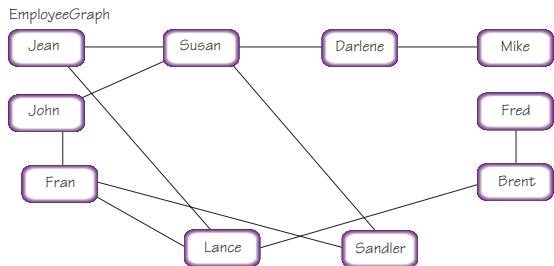
```

- Exercises 51–55 are short-answer questions based on the following directed graph.



51. Is there a path from *Oregon* to any other state in the graph?
52. Is there a path from *Hawaii* to every other state in the graph?
53. From which state(s) in the graph is there a path to *Hawaii*?
54. Show the table that represents this graph.
55. Can you get from *Vermont* to *Hawaii*?

- Exercises 56–60 are short-answer questions based on the following directed graph.



56. Show the depth-first traversal from *Jean* to *Sandler*.
57. Show the depth-first traversal from *Lance* to *Darlene*.
58. Show the breadth-first traversal from *Jean* to *Sandler*.
59. Show the breadth-first traversal from *Lance* to *Darlene*.
60. Show the table that represents this graph.

- Exercises 61–69 are short-answer exercises.

61. Given the record *List* containing the array values and the variable length, write the algorithm for *GetLength*.
62. Assume that record *List* has an additional variable *currentPosition*, initialized to the first item in the

**EXERCISES (CONTINUED)**

- list. What is the initial value of *currentPosition*?
63. Write the algorithm for *MoreItems*, which returns `TRUE` if there are more items in the list and `FALSE` otherwise.
  64. Write the algorithm for *GetNext(myList, item)* so that *item* is the next item in the list. Be sure to update *currentPosition*.
  65. Exercises 61–64 create the algorithms that allow the user of a list to see the items one at a time. Write the algorithm that uses these operations to print the items in a list.
  66. What happens if an insertion or deletion occurs in the middle of an iteration through the list? Explain.
  67. Can you think of a way to keep the user from doing an insertion or deletion during an iteration?
  68. Distinguish between value and reference parameters.
  69. How are arguments and parameters matched?

**THOUGHT QUESTIONS**

1. A spreadsheet is a table with rows and columns. Think about an ADT spreadsheet. Which operations would you need to construct the table? Which operations would you need to manipulate the values in the table?
2. Binary trees, binary search trees, and graphs are visualized as nodes and arrows (pointers) that represent the relationships between nodes. Compare these structures in terms of the operations that are allowed. Can a list ever be a tree? Can a tree ever be a list? Can a tree ever be a graph? Can a graph ever be a tree? How do the structures all relate to one another?
3. Before computers, water-cooler conversations were thought to be private. How has computer technology changed this assumption?
4. How do the rights of employees collide with privacy rights in the workplace?

## Laying the Groundwork

- 1 The Big Picture

## The Information Layer

- 2 Binary Values and Number Systems
- 3 Data Representation

## The Hardware Layer

- 4 Gates and Circuits
- 5 Computing Components

## The Programming Layer

- 6 Low-Level Programming Languages and Pseudocode
- 7 Problem Solving and Algorithms
- 8 Abstract Data Types and Subprograms
- 9 Object-Oriented Design and High-Level Programming Languages

## The Operating Systems Layer

- 10 Operating Systems
- 11 File Systems and Directories

## The Applications Layer

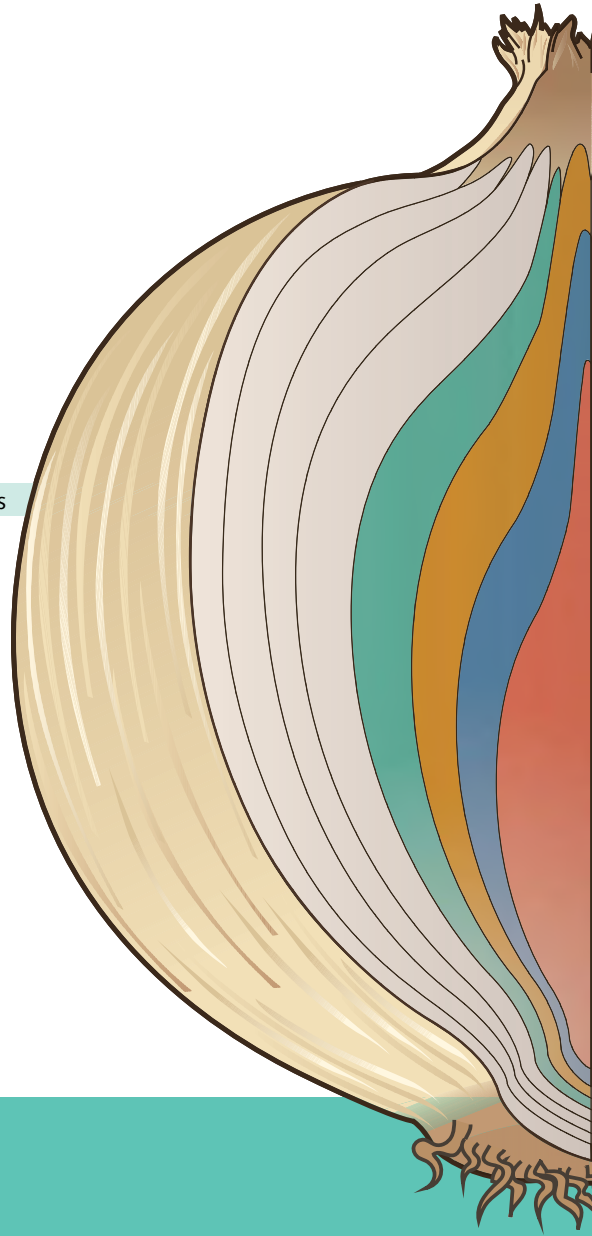
- 12 Information Systems
- 13 Artificial Intelligence
- 14 Simulation, Graphics, Gaming, and Other Applications

## The Communications Layer

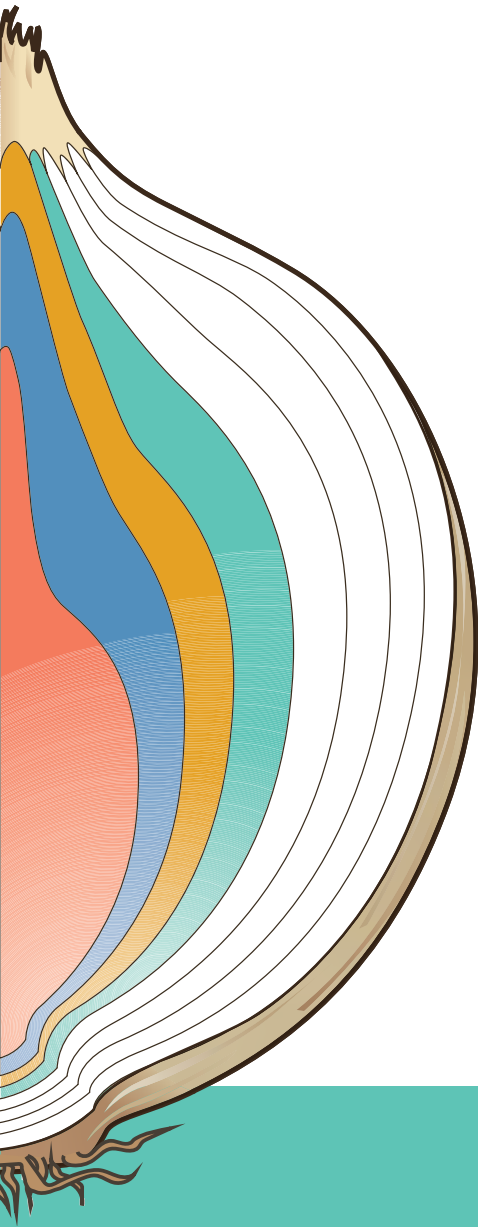
- 15 Networks
- 16 The World Wide Web
- 17 Computer Security

## In Conclusion

- 18 Limitations of Computing



# THE PROGRAMMING LAYER



# OBJECT-ORIENTED DESIGN AND HIGH-LEVEL PROGRAMMING LANGUAGES

## 9

In Chapter 1, we examined how the layers of languages were built up over time around the hardware to make computing easier for the applications programmer. In Chapter 6, we looked at machine code and then at an assembly language that allows the programmer to use mnemonics to represent instructions rather than numbers.

Assembly languages are a step in the right direction, but the programmer still must think in terms of individual machine instructions. To overcome this obstacle, we introduced pseudocode as an informal way to describe algorithms; pseudocode is closer to how humans think and communicate. High-level programming languages are a very formal way of accomplishing the same thing. Because computers can execute only machine code, translators were developed to translate programs written in these high-level languages into machine code.

## GOALS

After studying this chapter, you should be able to:

- distinguish between functional design and object-oriented design.
- describe the stages of the object-oriented design process.
- apply the object-oriented design process.
- name, describe, and give examples of the three essential ingredients of an object-oriented language.
- describe the translation process and distinguish between assembly, compilation, interpretation, and execution.
- name four distinct programming paradigms and give a language characteristic of each.
- define the concepts of data type and strong typing.
- understand how the constructs of top-down design and object-oriented design are implemented in programming languages.

Before we look at high-level languages, we make a detour to look at object-oriented design. Object-oriented design is another way of looking at the design process, which views a program from the standpoint of data rather than tasks. Because the functionality associated with this design process is often incorporated into high-level programming languages, we need to understand this design process before looking at specific high-level languages.

?

**It's in! No, it's out!**

Have you ever watched a tennis match on television in which a player asks for confirmation of a line call? On a big screen, you can see the path of the ball and the point of impact that shows whether the ball was in or out. How do they do it? By computer, of course. One system uses four high-speed digital cameras with computer software that can track a ball, determine its trajectory, and map its impact point. These cameras are connected to one another and to a main computer using wireless technology.

**Object** An entity or thing that is relevant in the context of a problem

**Object class (class)**  
A description of a group of objects with similar properties and behaviors

## 9.1 Object-Oriented Methodology

We cover top-down design first because it more closely mirrors the way humans solve problems. As you saw earlier in this book, a top-down solution produces a hierarchy of tasks. Each task or named action operates on the data passed to it through its parameter list to produce the desired output. The tasks are the focus of a top-down design. Object-oriented design, by contrast, is a problem-solving methodology that produces a solution to a problem in terms of self-contained entities called *objects*, which are composed of both data and operations that manipulate the data. Object-oriented design focuses on the objects and their interactions within a problem. Once all of the objects within the problem are collected together, they constitute the solution to the problem.

In this process, Polya's principles of problem solving are applied to the data rather than to the tasks.

### Object Orientation

Data and the algorithms that manipulate the data are bundled together in the object-oriented view, thus making each object responsible for its own manipulation (behavior). Underlying object-oriented design (OOD) are the concepts of *classes* and *objects*.

An **object** is an entity that makes sense within the context of the problem. For example, if the problem relates to information about students, a student would be a reasonable object in the solution. A group of similar objects is described by an **object class** (or **class** for short). Although no two students are identical, students do have properties (data) and behaviors (actions) in common. Students are humans who attend courses at a school (at least most of the time). Therefore, students would be a class. The word *class* refers to the idea of classifying objects into related groups and describing their common characteristics. That is, a class describes the properties and behaviors that objects of the class exhibit. Any particular object is an *instance* (concrete example) of the class.



Object-oriented problem solving involves isolating the classes within the problem. Objects communicate with one another by sending messages (invoking one another's subprograms). A class contains **fields** that represent the properties of the class. For example, a field of the class representing a student might be the student's name or ID number. A **method** is a named algorithm that manipulates the data values in the object. A class is a representation for what an object is (fields) and how it behaves (methods).

**Fields** Named properties of a class  
**Method** A named algorithm that defines one aspect of the behavior of a class

## Design Methodology

The decomposition process that we present involves four stages. *Brainstorming* is the stage in which we make a first pass at determining the classes in the problem. *Filtering* is the stage in which we go back over the proposed classes determined in the brainstorming stage to see if any can be combined or if any are missing. Each class that survives the filtering stage is examined more carefully in the next stage.

*Scenarios* is the stage in which the behavior of each class is determined. Because each class is responsible for its own behavior, we call these behaviors *responsibilities*. In this stage, "what if" questions are explored to be sure that all situations are examined. When all of the responsibilities of each class have been determined, they are recorded, along with the names of any other classes with which the class must collaborate (interact) to complete its responsibility.

*Responsibility algorithms* is the last stage, in which the algorithms are written for the responsibilities for each of the classes. A notation device called a *CRC card* is a handy way to record the information about each class at this stage.

Let's look at each of these stages in a little more detail.

### Brainstorming

What is brainstorming? The dictionary defines it as a group problem-solving technique that involves the spontaneous contribution of ideas from all members of the group.<sup>1</sup> Brainstorming brings to mind a movie or TV show where a group of bright young people tosses around ideas about an advertising slogan for the latest revolutionary product. This picture seems at odds with the traditional picture of a computer analyst working alone in a closed, windowless office for days who finally jumps up shouting, "Ah ha!" As computers have gotten more powerful, the problems that can be solved have become more complex, and the picture of the genius locked in a windowless room has become obsolete. Solutions to



complex problems need new and innovative solutions based on collective “Ah ha!”s—not the work of a single person.

In the context of object-oriented problem solving, brainstorming is a group activity designed to produce a list of possible classes to be used to solve a particular problem. Just as the people brainstorming to create an advertising slogan need to know something about the product before the session begins, brainstorming for classes requires that the participants know something about the problem. Each team member should enter the brainstorming session with a clear understanding of the problem to be solved. No doubt during the preparation, each team member will have generated his or her own preliminary list of classes.

Although brainstorming is usually a group activity, you can practice it by yourself on smaller problems.

### Filtering

Brainstorming produces a tentative list of classes. The next phase is to take this list and determine which are the core classes in the problem solution. Perhaps two classes on the list are actually the same thing. These duplicate classes usually arise because people within different parts of an organization use different names for the same concept or entity. Also, two classes in the list may have many common attributes and behaviors that can be combined.

Some classes might not actually belong in the problem solution. For example, if we are simulating a calculator, we might list the user as a possible class. In reality, the user is not part of the internal workings of the simulation as a class; the user is an entity outside the problem who provides input to the simulation. Another possible class might be the *on* button. A little thought, however, shows that the *on* button is not part of the simulation; rather, it is what starts the simulation program running.

As the filtering is completed, the surviving list of classes is passed onto the next stage.

### Scenarios

The goal of the scenarios phase is to assign responsibilities to each class. Responsibilities are eventually implemented as subprograms. At this stage we are interested only in *what* the tasks are, not in how they might be carried out.

Two types of responsibilities exist: what a class must know about itself (knowledge) and what a class must be able to do (behavior). A class *encapsulates* its data (knowledge) such that objects in one class cannot directly

access data in another class. **Encapsulation** is the bundling of data and actions so that the logical properties of the data and actions are separated from the implementation details. Encapsulation is a key to abstraction. At the same time, each class has the responsibility of making data (knowledge) available to other classes that need it. Therefore, each class has a responsibility to know the things about itself that others need to be able to get. For example, a student class should “know” its name and address, and a class that uses the student class should be able to “get” this information. These responsibilities are usually named with “Get” preceding the name of the data—for example, *GetName* or *GetEmailAddress*. Whether the email address is kept in the student class or whether the student class must ask some other class to access the address is irrelevant at this stage: The important fact is that the student class knows its own email address and can return it to a class that needs it.

The responsibilities for behavior look more like the tasks we described in top-down design. For example, a responsibility might be for the student class to calculate its grade point average (GPA). In top-down design, we would say that a task is to calculate the GPA given the data. In object-oriented design, we say that the student class is responsible for calculating its own GPA. The distinction is both subtle and profound. The final code for the calculation may look the same, but it is executed in different ways. In a program based on a top-down design, the program calls the subprogram that calculates the GPA, passing the student object as a parameter. In an object-oriented program, a message is sent to the object of the class to calculate its GPA. There are no parameters because the object to which the message is sent knows its own data.

The name for this phase gives a clue about how you go about assigning responsibilities to classes. The team (or an individual) describes different processing scenarios involving the classes. Scenarios are “what if” scripts that allow participants to act out different situations or an individual to think through them.

The output from this phase is a set of classes with each class’s responsibilities assigned, perhaps written on a CRC card. The responsibilities for each class are listed on the card, along with the classes with which a responsibility must collaborate.

## Responsibility Algorithms

Eventually, algorithms must be written for the responsibilities. Because the problem-solving process focuses on data rather than actions in the object-oriented view of design, the algorithms for carrying out responsibilities

### Encapsulation

Bundling data and actions so that the logical properties of data and actions are separated from the implementation details

tend to be fairly short. For example, the knowledge responsibilities usually just return the contents of one of an object's variables or send a message to another object to retrieve it. Action responsibilities are a little more complicated, often involving calculations. Thus the top-down method of designing an algorithm is usually appropriate for designing action-responsibility algorithms.

## Final Word

To summarize, top-down design methods focus on the *process* of transforming the input into the output, resulting in a hierarchy of tasks. Object-oriented design focuses on the *data objects* that are to be transformed, resulting in a hierarchy of objects. Grady Booch puts it this way: "Read the specification of the software you want to build. Underline the verbs if you are after procedural code, the nouns if you aim for an object-oriented program."<sup>2</sup>

We propose that you circle the nouns and underline the verbs as a way to begin. The nouns become objects; the verbs become operations. In a top-down design, the verbs are the primary focus; in an object-oriented design, the nouns are the primary focus.

Now, let's work through an example.

## Example

### Problem

Create a list that includes each person's name, telephone number, and email address. This list should then be printed in alphabetical order. The names to be included in the list are on scraps of paper and business cards.

### Brainstorming and Filtering

Let's try circling the nouns and underlining the verbs.

Create a list that includes each person name, telephone number, and email address. This list should then be printed in alphabetical order. The names to be included in the list are on scraps of paper and business cards.

The first pass at a list of classes would include the following:

```
list
name
telephone number
email address
list
order
names
list
scraps
paper
cards
```

Three of these classes are the same: The three references to *list* all refer to the container being created. *Order* is a noun, but what is an *order class*? It actually describes how the list class should print its items. Therefore, we discard it as a class. *Name* and *names* should be combined into one class. *Scraps*, *paper*, and *cards* describe objects that contain the data in the real world. They have no counterpart within the design. Our filtered list is shown below:

```
list
name
telephone number
email address
```

The verbs in the problem statement give us a headstart on the responsibilities: *create*, *print*, and *include*. Like *scraps*, *paper*, and *cards*, *include* is an instruction to someone preparing the data and has no counterpart within the design. However, it does indicate that we must have an object that inputs the data to be put on the list. Exactly what is this data? It is the name, telephone number, and email address of each person on the list. But this train of thought leads to the discovery that we have missed a major clue in the problem statement. A possessive noun, *person's*, actually names a major class; *name*, *telephone number*, and *email address* are classes that help define (are contained within) a *person* class.

Now we have a design choice. Should the *person* class have a responsibility to input its own data to initialize itself, or should we create another class that does the input and sends the data to initialize the *person* class? Let's have the *person* class be responsible for initializing itself. The *person* class should also be responsible for printing itself.

Does the *person* class collaborate with any other class? The answer to this question depends on how we decide to represent the data in the *person* class. Do we represent *name*, *telephone number*, and *email address* as simple data items within the *person* class, or do we represent each as its own class? Let's represent *name* as a class with two data items, *firstName* and *lastName*, and have the others be string variables in the class *person*. Both classes *person* and *name* must have knowledge responsibilities for their data values. Here are the CRC cards for these classes.

| Class Name: <i>Person</i>                         | Superclass:         | Subclasses: |
|---------------------------------------------------|---------------------|-------------|
| Responsibilities                                  | Collaborations      |             |
| <i>Initialize itself (name, telephone, email)</i> | <i>Name, String</i> |             |
| <i>Print</i>                                      | <i>Name, String</i> |             |
| <i>getEmail</i>                                   | <i>String</i>       |             |
| <i>getName</i>                                    | <i>Name, String</i> |             |
| <i>getTelephone</i>                               | <i>String</i>       |             |

| Class Name: <i>Name</i>                        | Superclass:    | Subclasses: |
|------------------------------------------------|----------------|-------------|
| Responsibilities                               | Collaborations |             |
| <i>Initialize itself (firstName, lastName)</i> | <i>String</i>  |             |
| <i>Print itself</i>                            | <i>String</i>  |             |
| <i>getFirstName</i>                            | <i>String</i>  |             |
| <i>getLastName</i>                             | <i>String</i>  |             |
|                                                |                |             |

What about the list object? Should the list keep the items in alphabetical order, or should it sort the items before printing them? Each language in which we might implement this design has a library of container classes available for use. Let's use one of these classes, which keeps the list in alphabetical order. This library class should also print the list. We

?

### Beware of pirated software

A 2013 study analyzed 270 websites and peer-to-peer networks, 108 software downloads, 155 CDs or DVDs, 2077 consumer interviews, and 258 interviews of IT managers around the world. The results showed that of the counterfeit software that does not ship with the computer, 45% is downloaded from the Internet. Of software downloaded from websites or peer-to-peer networks, 78% include some type of spyware and 36% contain Trojans and adware.<sup>3</sup>

can create a CRC card for this class, but mark that it most likely will be implemented using a library class.

|                                                 |                |             |
|-------------------------------------------------|----------------|-------------|
| Class Name:<br><i>SortedList (from library)</i> | Superclass:    | Subclasses: |
| Responsibilities                                | Collaborations |             |
| <i>Insert (person)</i>                          | <i>Person</i>  |             |
| <i>Print itself</i>                             | <i>Person</i>  |             |
|                                                 |                |             |
|                                                 |                |             |
|                                                 |                |             |

By convention, when a class reaches the CRC stage, we begin its identifier with an uppercase letter.

## Responsibility Algorithms

**Person Class** There are two responsibilities to be decomposed: initialize and print. Because *Name* is a class, we can just let it initialize and print itself. We apply a subprogram (method) to an object by placing the object name before the method name with a period in between.

© Artur Debat/Getty Images; © Alan Dyer/Stocktrek Images/Getty Images

### Initialize

```
name.initialize()
Write "Enter phone number; press return."
Get telephone number
Write "Enter email address; press return."
Get email address
```

© Artur Debat/Getty Images; © Alan Dyer/Stocktrek Images/Getty Images

### Print

```
name.print()
Write "Telephone number: ", telephoneNumber
Write "Email address: ", emailAddress
```

**Name Class** This class has the same two responsibilities: initialize and print. However, the algorithms are different. For the initialize responsibility, the user must be prompted to enter the name and the algorithm must read the name. For the print responsibility, the first and last names must be output with appropriate labels.

© Artur Debat/Getty Images, © Alan Dyer/Stocktrek Images/Getty Images

#### Initialize

“Enter the first name; press return.”

Read firstName

“Enter the last name; press return.”

Read lastName

© Artur Debat/Getty Images, © Alan Dyer/Stocktrek Images/Getty Images

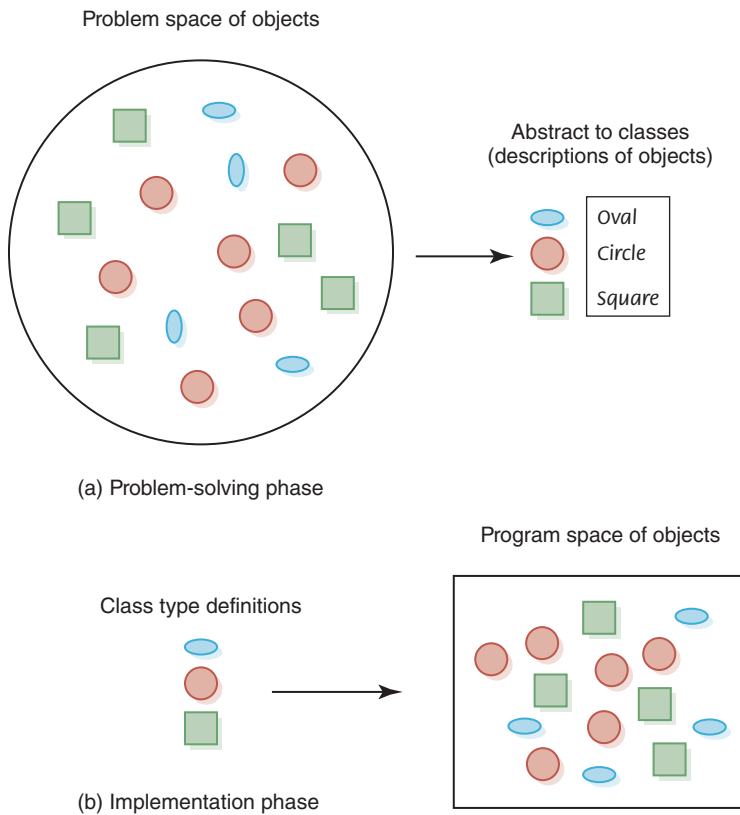
#### Print

Print “First name: ”, firstName

Print “Last name: ”, lastName

We stop the design at this point. Reread the beginning of Chapter 7, where we discuss problem solving and the top-down design process. A top-down design produces a hierarchical tree with tasks in the nodes of the tree. The object-oriented design produces a set of classes, each of which has responsibilities for its own behavior. Is one better than the other? Well, the object-oriented design creates classes that might be useful in other contexts. Reusability is one of the great advantages of an object-oriented design. Classes designed for one problem can be used in another problem, because each class is self-contained; that is, each class is responsible for its own behavior.

You can think of the object-oriented problem-solving phase as mapping the objects in the real world into classes, which are descriptions of the categories of objects. The implementation phase takes the descriptions of the categories (classes) and creates instances of the classes that simulate



**FIGURE 9.1** Mapping of a problem into a solution

the objects in the problem. The interactions of the objects in the program simulate the interaction of the objects in the real world of the problem.

**FIGURE 9.1** summarizes this process.

## 9.2 Translation Process

Recall from Chapter 6 that a program written in assembly language is input to the *assembler*, which translates the assembly-language instructions into machine code. The machine code, which is the output from the assembler, is then executed. With high-level languages, we employ other software tools to help with the translation process. Let's look at the basic function of these tools before examining high-level languages.



## Compilers

The algorithms that translate assembly-language instructions into machine code are very simple because assembly languages are very simple. By “simple,” we mean that each instruction carries out a fundamental operation. High-level languages provide a richer set of instructions that makes the programmer’s life even easier, but because the constructs are more abstract, the translation process is more difficult. Programs that translate programs written in a high-level language are called **compilers**. In the early days of computer programming, the output of a compiler was an assembly-language version of the program, which then had to be run through an assembler to finally get the machine-language program to execute. As computer scientists began to have a deeper understanding of the translation process, compilers became more sophisticated and the assembly-language phase was often eliminated. See [FIGURE 9.2](#).

A program written in a high-level language can run on any computer that has an appropriate compiler for the language. A compiler is a program; therefore, a machine-code version of the compiler must be available for a particular machine to be able to compile a program. Thus, to be used on multiple types of machines, each high-level language must have many compilers for that language.

**Compiler** A program that translates a high-level language program into machine code

**Interpreter** A program that inputs a program in a high-level language and directs the computer to perform the actions specified in each statement

## Interpreters

An **interpreter** is a program that translates and executes the statements in sequence. Unlike an assembler or compiler that produces machine code as output, which is then executed in a separate step, an interpreter translates a statement and then immediately executes the statement. Interpreters can be viewed as *simulators* or *virtual machines* that understand the

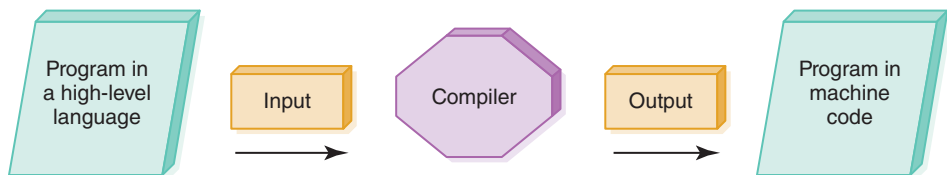


FIGURE 9.2 Compilation process

language in which a program is written. As Terry Pratt points out in his classic text on programming languages, both a translator and a simulator accept programs in a high-level language as input. The translator (assembler or compiler) simply produces an equivalent program in the appropriate machine language, which must then be run. The simulator executes the input program directly.<sup>4</sup>

Second-generation high-level languages came in two varieties: those that were compiled and those that were interpreted. FORTRAN, COBOL, and ALGOL were compiled; Lisp, SNOBOL4, and APL were interpreted. Because of the complexity of the software interpreters, programs in interpreted languages usually ran much more slowly than compiled programs. As a result, the trend was toward compiled languages—until the advent of Java.

Java was introduced in 1996 and took the computing community by storm. In the design of Java, portability was of primary importance. To achieve optimal portability, Java is compiled into a standard machine language called **Bytecode**. But how can there be a *standard machine language*? A software interpreter called the JVM (Java Virtual Machine) takes the Bytecode program and executes it. That is, Bytecode is not the machine language for any particular hardware processor. Any machine that has a JVM can run the compiled Java program.

The portability achieved by standardized high-level languages is not the same as the portability achieved by translating Java into Bytecode and then interpreting it on a JVM. A program written in a high-level language can be compiled and run on any machine that has the appropriate compiler; the program is translated into machine code that is directly executed by a computer. A Java program is compiled into Bytecode, and the compiled Bytecode program can run on any machine that has a JVM interpreter. That is, the output from the Java compiler is interpreted, not directly executed. (See [FIGURE 9.3](#).) Java is always translated into Bytecode. In addition, there are compilers for other languages that translate the language into Bytecode rather than machine code. For example, there are versions of Ada compilers that translate Ada into Bytecode.

The JVM is a virtual machine, just like the Pep/9 system discussed in Chapter 6. In that chapter, we defined a virtual machine as a hypothetical machine designed to illustrate important features of a real machine. The JVM is a hypothetical machine designed to execute Bytecode.

**Bytecode** A standard machine language into which Java source code is compiled

#### UCSD's p-system predates Bytecode

In the 1970s, the University of California at San Diego had a system that executed p-code, a language very similar to Java Bytecode. Programs written in Pascal and FORTRAN were translated into p-code, which could be executed on any hardware with a p-code interpreter.

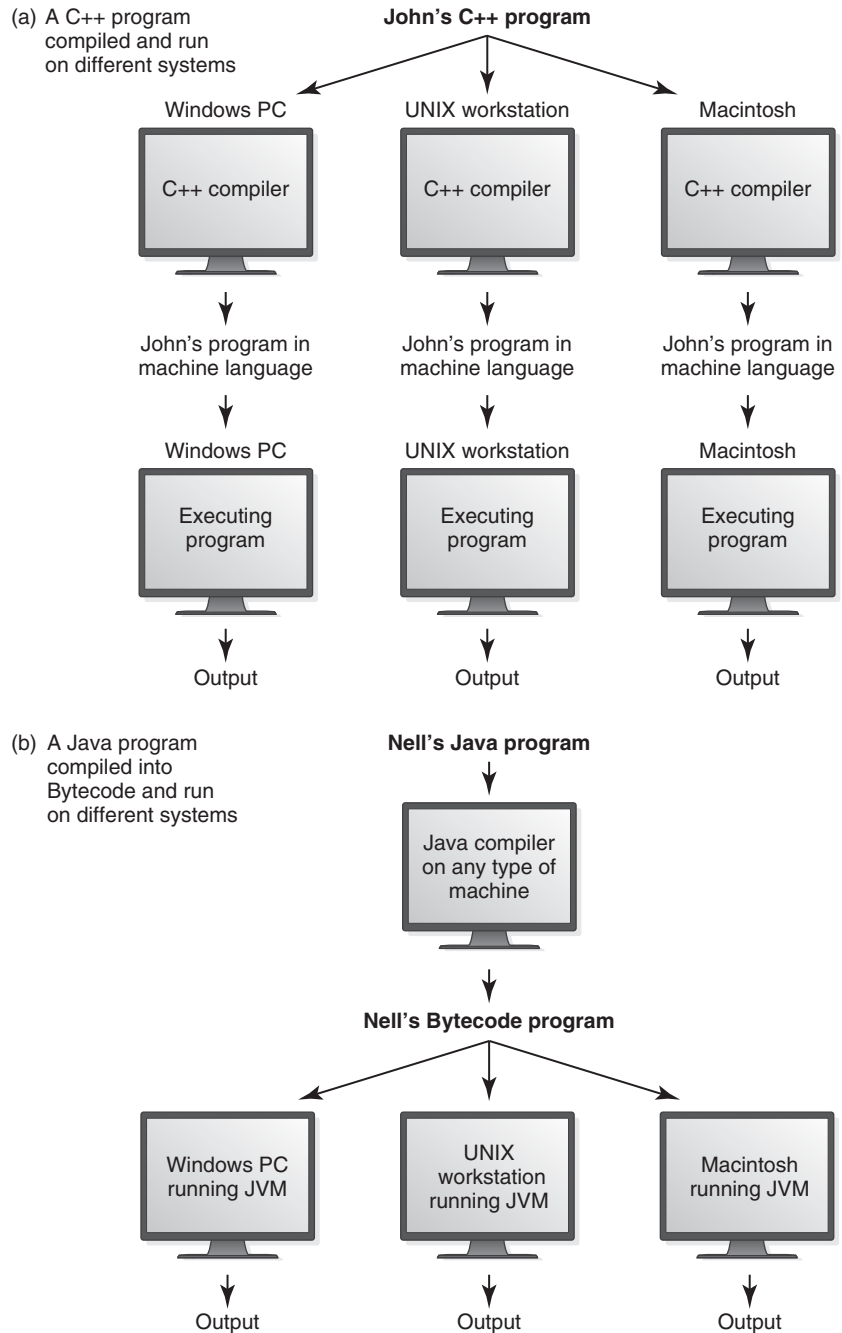


FIGURE 9.3 Portability improvement because of Bytecode interpretation

## 9.3 Programming Language Paradigms

What is a *paradigm*? The *American Heritage Dictionary of the English Language* gives two definitions that relate to how we, in computing, use the term: “one that serves as a pattern or model” and “a set of assumptions, concepts, values, and practices that constitute a way of viewing reality for the community that shares them, especially in an intellectual discipline.”<sup>5</sup> In Chapter 1, we outlined the history of software development, listing some of the programming languages that were developed in each generation. Another way to view programming languages is to look at the ways in which different languages reflect differing views of reality—that is, to look at the different paradigms represented.

There are two main paradigms, imperative and declarative, and many subparadigms within each. We later look at different languages within these paradigms.

### Imperative Paradigm

The von Neumann model of sequential instructions that operates on values in memory greatly influenced the most common model of a programming language: the *imperative* model. The dominant languages used in industry throughout the history of computing software come from this paradigm. These languages include FORTRAN, BASIC, C, Pascal, and C++. In this paradigm, the program describes the processing necessary to solve the problem. The imperative paradigm is, therefore, characterized by sequential execution of instructions, the use of variables that represent memory locations, and the use of assignment statements that change the values of these variables.<sup>7</sup>

### Procedural Paradigm

*Procedural programming* is an imperative model in which the statements are grouped into subprograms. A program is a hierarchy of subprograms, each of which performs a specific task necessary to the solution of the overall program. Our pseudocode examples follow this model. We write subprograms and pass the data to them that they need to accomplish their function.

### Object-Oriented Paradigm

The object-oriented view is one of a world of interacting objects. Each object has responsibility for its own actions. In the procedural paradigm, data objects are considered passive and are acted upon by the program. In the object-oriented paradigm, data objects are active. Objects and the

#### What is a paradigm?



The word *paradigm* can be defined as a pattern or an example of something. The word also connotes the ideas of a mental picture and pattern of thought. Thomas Kuhn uses the word to mean the model that scientists hold about a particular area of knowledge. Kuhn's famous book, *The Structure of Scientific Revolutions*, presents his view of the stages through which a science goes in getting from one paradigm to the next.<sup>6</sup>

code that manipulates them are bundled together, making each object responsible for its own manipulation. SIMULA and Smalltalk were the first two object-oriented programming languages. Java and Python are two modern object-oriented languages.

C++ and Java are imperative languages that are somewhat mixed in terms of their paradigm. Although Java is considered object-oriented, it has some procedural features. C++ is considered procedural, but it has some object-oriented features.

Examples of particular languages are presented in this book, but are not intended to be comprehensive enough to give a student a working knowledge of the language. However, the supplements available for this book include lab exercises for several languages, including Java and C++, which go into more depth.

## Declarative Paradigm

The *declarative* paradigm is a model in which the results are described, but the steps to accomplish the results are not stated. There are two basic models within this paradigm, functional and logic.

### Functional Model

The *functional* model is based on the mathematical concept of the function. Computation is expressed in terms of the evaluation of functions; the solution to a problem is expressed in terms of function calls. Thus the basic mechanism is the evaluation of functions, and there are no variables and no assignment statements. For example, the addition of two values would be expressed this way:

```
(+ 30 40)
```

where the parentheses represent an expression to be evaluated by applying the first item (which must be a function) to the rest of the list. This expression is evaluated by applying the addition function to the next two numbers, which returns the value 70. There is no looping construct; repetition is expressed in terms of recursive function calls. The most well-known languages in the functional paradigm are Lisp, Scheme (a derivative of Lisp), and ML.

Let's examine a series of Scheme expressions that illustrate the flavor of the language. Scheme is interpreted, so the result immediately follows the statement. One interpreter uses `#;>` as a prompt to enter an

expression; we shall use that here.<sup>8</sup> The lines without the prompt are what the system returns.

```

#;> (* 3 4)
12
#;> (+ (* 5 4)(+ 1 4))
25
#;> (length '(2 4 6 8 10))
5
#;> (max 2 5 1 3)
5

```

In the first expression, 3 is multiplied by 4, giving the result 12. In the second expression, the results of multiplying 5 times 4 and adding 1 and 4 are summed, giving 25. The third expression asks for the number of items in the list following the list indicated by the ' mark. In the fourth expression, the maximum of the following values is returned.

In Chapter 7, we wrote a recursive algorithm to compute the factorial of a number. `lambda` is the word for defining a function. Here is the corresponding Scheme code—compare it with the first algorithm:

```

#;> (define factorial
#;> (lambda(n)
#;> (if
#;> (= n 0)
#;> 1
#;> (* n (factorial (- n 1))))))
#;> (factorial 7)
5040

```

After the factorial function is defined, giving the name and argument within parentheses executes the function, returning the value 5040.

## Logic Programming

*Logic programming* is based on the principles of symbolic logic. This model comprises a set of facts about objects and a set of rules about the relationships among the objects. A program consists of asking questions about these objects and their relationships, which can be deduced from the facts and the rules. The underlying problem-solving algorithm uses the rules of logic to deduce the answer from the facts and rules.

Prolog is a third-generation logic programming language that was developed in France in 1970. It rose to prominence in 1981, when Japanese researchers announced that logic programming would play a major role in their fifth-generation computer. A Prolog program consists of three

types of statements: One type declares facts about objects and their relationships with and to each other; another type defines rules about objects and their relationships; and a third type asks questions about the objects and their relationships.<sup>9</sup>

For example, the following code defines a set of facts relating pets to owners:

```
owns(mary,bo).
owns(ann,kitty).
owns(bob,riley).
owns(susy,charlie).
```

Here `owns` is the relationship name, the objects are within parentheses, and the period ends the statement of the fact. Does this mean that `mary` owns `bo` or `bo` owns `mary`? That is up to the programmer. He or she must be consistent in his or her interpretation.

When you have a database of facts, Prolog allows you to ask questions about the database. Look at these three Prolog statements:

```
?-owns(mary,bo)
?-owns(bo,mary)
?-owns(susy,bo)
```

The Prolog system replies `yes` to the first, `no` to the second, and `no` to the third.

In Prolog, a constant begins with a lowercase letter and a variable begins with an uppercase letter. We ask questions about facts by substituting a variable for a constant in a fact.

```
?-owns(ann,Cat).
?-owns(Name,charlie).
```

In this example, the first statement returns `Cat = kitty`. The second returns `Name = susy`.

Both Lisp and Prolog are used in artificial intelligence applications (described in Chapter 13). As you can see, programs in these languages bear little resemblance to the von Neumann architecture reflected in languages in the imperative paradigm as represented in our pseudocode.

## 9.4 Functionality in High-Level Languages

Two pseudocode constructs—selection and repetition (looping)—are hallmarks of imperative languages. In Chapter 6, we implemented these constructions in assembly language, showing how detailed the instructions

had to be. We also examined these constructs along with subprograms in pseudocode. In high-level languages, selection and repetition are very easy. Subprograms and parameter passing, however, are more complicated.

First, we review the concept of a Boolean expression, which is the construct that high-level languages use to make choices. We then examine other constructs that high-level languages provide to make programming easier and safer.

## Boolean Expressions

In Chapter 6, we wrote an algorithm to read in pairs of numbers and print them in order. It contained a selection statement within a loop. Here is the outline of the loop with the selection statement:

```

...
WHILE (numberRead < numberOfPairs)
 ...
 IF (number1 < number2)
 Print number1, " ", number2
 ELSE
 Print number2, " ", number1

```

Each of these statements asks a question. Notice how these questions are phrased:

```

(numberRead < numberOfPairs)
(number1 < number2)

```

Each phrase is actually a statement. If the statement is true, the answer to the question is true. If the statement is not true, the answer to the question is false. Making statements and then testing whether they are true or false is how programming languages ask questions. These statements are called *assertions* or *conditions*. When we write algorithms, we make assertions in English-like statements. When the algorithms are translated into a high-level programming language, the English-like statements are rewritten as Boolean expressions.



**Boolean expression**

A sequence of identifiers, separated by compatible operators, that evaluates to either true or false

What is a Boolean expression? In Chapter 4, we introduced the concept of Boolean operations when we discussed gates and circuits. Here we are using them at the logical level rather than the hardware level. A **Boolean expression** is a sequence of identifiers, separated by compatible operators, that evaluates to either true or false. A Boolean expression can be any of the following.

- A Boolean variable
- An arithmetic expression followed by a relational operator followed by an arithmetic expression
- A Boolean expression followed by a Boolean operator followed by a Boolean expression

So far in our examples, variables have contained numeric values. A Boolean variable is a location in memory that is referenced by an identifier that can contain either `true` or `false`. (When referring to code in a specific language or to what is actually stored in memory, we use a monospace, or code, font.)

A relational operator is one that compares two values. The six relational operators are summarized in the following chart, along with the symbols that various high-level languages use to represent the relation.

A relational operator between two arithmetic expressions is asking if the relationship exists between the two expressions. For example,

`xValue < yValue`

is making the assertion that `xValue` is less than `yValue`. If `xValue` is less than `yValue`, then the result of the expression is true; if `xValue` is not less than `yValue`, then the result is false.

| Symbol                                                      | Meaning               | Example                            | Evaluation                                                                                      |
|-------------------------------------------------------------|-----------------------|------------------------------------|-------------------------------------------------------------------------------------------------|
| <code>&lt;</code>                                           | Less than             | <code>Number1 &lt; Number2</code>  | True if <code>Number1</code> is less than <code>Number2</code> ; false otherwise                |
| <code>&lt;=</code>                                          | Less than or equal    | <code>Number1 &lt;= Number2</code> | True if <code>Number1</code> is less than or equal to <code>Number2</code> ; false otherwise    |
| <code>&gt;</code>                                           | Greater than          | <code>Number1 &gt; Number2</code>  | True if <code>Number1</code> is greater than <code>Number2</code> ; false otherwise             |
| <code>&gt;=</code>                                          | Greater than or equal | <code>Number1 &gt;= Number2</code> | True if <code>Number1</code> is greater than or equal to <code>Number2</code> ; false otherwise |
| <code>!=</code> or <code>&lt;&gt;</code> or <code>/=</code> | Not equal             | <code>Number1 != Number2</code>    | True if <code>Number1</code> is not equal to <code>Number2</code> ; false otherwise             |
| <code>=</code> or <code>==</code>                           | Equal                 | <code>Number1 == Number2</code>    | True if <code>Number1</code> is equal to <code>Number2</code> ; false otherwise                 |

To avoid the confusion over the use of = and == to mean equality in different programming languages, we have used the word “equals” rather than choosing one of the symbols in our algorithms.

Recall that the three Boolean operators are the special operators AND, OR, and NOT. The AND operator returns *true* if both expressions are *true* and *false* otherwise. The OR operator returns *false* if both expressions are *false* and *true* otherwise. The NOT operator changes the value of the expression.

## Data Typing

When working in an assembly language, we assign identifiers to memory locations with no regard as to what is to be stored into the locations. Many widely used, high-level languages (including both C++ and Java) require you to state what can be stored in a place when you associate it with an identifier. If a statement in a program tries to store a value into a variable that is not the proper type, an error message is issued. The requirement that only a value of the proper type can be stored into a variable is called **strong typing**.

For example, look at the following 8 bits: 00110001. What does it represent? It is a byte in memory. Yes, but what does it *mean*? Well, it could be the binary representation of the decimal number 49. It could also be the extended ASCII representation of the character ‘1’. Could it mean anything else? Yes, it could be the Pep/9 instruction specifier for the DCI direct mode trap instruction. Thus, when a program is executing, it must know how to interpret the contents of a place in memory.

In the next sections, we look at common types of data values and explore how high-level languages allow you to associate locations with identifiers. Each of these data types has certain operations that legally can be applied to values of the type. A **data type** is a description of the set of values and the basic set of operations that can be applied to values of the type.

Of the languages we explore, C++, Java, and VB .NET are strongly typed; Python is not.

## Data Types

Data are the physical symbols that represent information. Inside a computer, both data and instructions are just binary bit patterns. The computer executes an instruction because the address of the instruction is loaded into the program counter and the instruction is then loaded into the instruction register. The same bit pattern that is executed can also represent an integer number, a real number, a character, or a Boolean value. The key is that the computer interprets the bit pattern to be what it expects it to be.

**Strong typing** Each variable is assigned a type, and only values of that type can be stored in the variable

**Data type** A description of the set of values and the basic set of operations that can be applied to values of the type

**Consider the word bow**

The string *bow* is an English word. However, it can mean different things: part of a ship, something a little girl wears in her hair, something you play the violin with, or the act of bending from the waist. We can differentiate between the meanings based on the context of the word, just as a compiler can differentiate based on the surrounding syntax.

For example, in Pep/9 the instruction for Stop is a byte of all zero bits. When this instruction is loaded into the instruction register, the program halts. A byte of all zero bits can also be interpreted as an 8-bit binary number containing the value 0 (zero). If the location containing all zero bits is added to the contents of a register, the value is interpreted as a number.

Most high-level languages have four distinct data types built into the language: integer numbers, real numbers, characters, and Boolean values.

**Integers** The integer data type represents a range of integer values, from the smallest to the largest. The range varies depending on how many bytes are assigned to represent an integer value. Some high-level languages provide several integer types of different sizes, which allows the user to choose the one that best fits the data in a particular problem.

The operations that can be applied to integers are the standard arithmetic and relational operators. Addition and subtraction are represented by the standard symbols + and -. Multiplication and division are usually represented by \* and /. Depending on the language, integer division may return a real number or the integer quotient. Some languages have two symbols for division: one that returns a real result and one that returns the integer quotient. Most languages also have an operator that returns the integer remainder from division. This operator is called the *modulus operator*, but it may or may not act as the mathematical modulus operator. The relational operators are represented by the symbols shown in the table in the previous section.

**Reals** The real data type also represents a range from the smallest to the largest value with a given precision. Like the integer data type, the range varies depending on the number of bytes assigned to represent a real number. Many high-level languages have two sizes of real numbers. The operations that can be applied to real numbers are the same as those that can be applied to integer numbers. However, you must be careful when applying the relational operators to real values, because real numbers are often not exact. For example,  $1/3 + 1/3 + 1/3$  in computer arithmetic is not necessarily 1.0. In fact,  $1/10 * 10$  is *not* 1.0 in computer arithmetic.

**Characters** In Chapter 3, we said that a mapping of the ASCII character set to code requires only one byte. One commonly used mapping for the Unicode character set uses two bytes. In this mapping, our English alphabet is represented in ASCII, which is a subset of Unicode. Applying arithmetic operations to characters doesn't make much sense, and many strongly typed languages will not allow you to do so. However, comparing characters does make sense, so the relational operators can be applied to

characters. The meanings of “less than” and “greater than,” when applied to characters, are “comes before” and “comes after,” respectively, in the character set. Thus the character ‘A’ is less than ‘B’, ‘B’ is less than ‘C’, and so forth. Likewise, the character ‘1’ (not the number) is less than ‘2’, ‘2’ is less than ‘3’, and so forth. If you want to compare ‘A’ to ‘1’, you must look up the relationship between these two characters in the character set you are using.

**Boolean** As we said in the previous section, the Boolean data type consists of two values: `true` and `false`. We can also assign a Boolean expression to a Boolean variable. Here is the pairs program using Boolean variables:

© Artur Debat/Getty Images, © Alan Dyer/Stocktrek Images/Getty Images

```

Write "How many pairs of values are to be entered?"
Read numberOfPairs
Set numberRead to 0
Set Stop to (numberRead equals numberOfPairs)
WHILE (NOT Stop)
 Write "Enter two values separated by a blank; press return"
 Read number1
 Read number2
 Set OneSmallest to number1 < number2
 IF (OneSmallest)
 Print number1, " ", number2
 ELSE
 Print number2, " ", number1
 Set numberRead to numberRead + 1
 Set Stop to (numberRead equals numberOfPairs)

```

Integers, reals, characters, and Booleans are called *simple* or *atomic* data types, because each value is distinct and cannot be subdivided into parts. In the last chapter, we discussed composite data types—that is, data types made up of a collection of values. The *string* data type has some of the properties of a composite type but is often considered a simple data type.

**Strings** A string is a sequence of characters that in some languages can be considered as one data value. For example,

“This is a string.”

is a string containing 17 characters: 1 uppercase letter, 12 lowercase letters, 3 blanks, and a period. The operations defined on strings vary from language to language, but often include a concatenation of strings and a comparison of strings in terms of lexicographic order. Other languages provide a complete array of operations, such as taking a substring of a given string or searching a given string for a substring.

Note that we have used single quotes to enclose characters and double quotes to enclose strings. Some high-level languages use the same symbol for both, thus not distinguishing between a character and a string with one character.

## Declarations

A **declaration** is a language statement that associates an identifier with a variable, an action, or some other entity within the language that can be given a name so that the programmer can refer to that item by name. In this section we discuss how a variable is declared. Later we look at how actions are given names.

**Declaration** A statement that associates an identifier with a variable, an action, or some other entity within the language that can be given a name so that the programmer can refer to that item by name

**Reserved word** A word in a language that has special meaning; it cannot be used as an identifier

| Language | Variable Declaration                                                                                                                                                                                                                                            |
|----------|-----------------------------------------------------------------------------------------------------------------------------------------------------------------------------------------------------------------------------------------------------------------|
| Python   | None required                                                                                                                                                                                                                                                   |
| VB .NET  | <pre>Dim sum As Single = 0.0F ' set up word with 0 as contents Dim num1 As Integer    ' set up a two byte block for num1 Dim num2 As Integer    ' set up a two byte block for num2 Dim num3 As Integer    ' set up a two byte block for num3 ... Num1 = 1</pre> |
| C++/Java | <pre>float sum = 0.0; // set up word with 0 as contents int num1;      // set up a two byte block for num1 int num2;      // set up a two byte block for num2 int num3;      // set up a two byte block for num3 ... Num1 = 1;</pre>                            |

These examples illustrate some differences among high-level languages. For example, VB .NET uses a reserved word to signal a declaration. A **reserved word** is a word in a language that has special meaning; it cannot be used as an identifier. `Dim` is a reserved word in VB .NET used to declare variables. C++ and Java do not use a reserved word for this purpose.

C++ and Java use the semicolon to end a statement in the language. VB .NET uses the end of the line or the *comment symbol* to end the statement. Python programs do not require declarations because Python is not a strongly typed language. Python uses the pound sign (`#`) as the beginning

of a comment that extends to the end of the line. Recall that Pep/9 uses a semicolon to signal that what follows is a comment.

C++, Java, Python, and VB .NET are **case sensitive**, which means that two copies of the same identifier, when capitalized differently, are considered different words. Thus, Integer, INTEGER, InTeGeR, and INTeger are considered four different identifiers in case-sensitive languages. C++, Java, and VB .NET have a collection of type names for various sizes of integer and real numbers. Although Python does not declare identifiers, it does have the reserved words `long`, `int`, `float`, and `bool`.

Are these differences important? They are if you are writing a program in one of these languages. However, they are just syntactic issues—that is, different ways of doing the same thing. The important concept is that an identifier is associated with a place in memory and may or may not be associated with a data type. In the exercises, we ask you to compare the syntactic differences that surface in these examples.

The use of uppercase and lowercase in identifiers is part of the culture of a language. In our examples, we have tried to stick with the style that is common within the language's culture. For example, most C++ programmers begin variable names with lowercase and subprograms with uppercase, while VB .NET programmers tend to begin variable names with uppercase letters.

## Input/Output Structures

In our pseudocode algorithms, we have used the expressions *Read* and *Write* or *Print* to indicate that we were interacting with the environment outside the program. *Read* was for getting a value from outside the program and storing it into a variable inside the program, and *Write* and *Print* were for displaying a message for the human to see.

High-level languages view text data as a stream of characters divided into lines. How the characters are interpreted depends on the data types of the places into which the values are to be stored. Any input statement has three parts: the declaration of the variables into which data will be placed, the input statement with the names of the variables to be read, and the data stream itself. As an example, let's look at the pseudocode algorithm to input three values:

*Read name, age, hourlyWage*

### Case sensitive

Uppercase and lowercase letters are not considered the same; two identifiers with the same spelling but different capitalization are considered to be two distinct identifiers

In a strongly typed language, the variables *name*, *age*, and *hourlyWage* would have to be declared, along with their respective data types. Let's assume the types are string, integer, and real. The input statement would list the three variables. Processing would proceed as follows. The first data item on the input stream would be assumed to be a string, because *name* is of type string. The string would be read and stored into *name*. The next variable is an integer, so the read operation expects to find an integer next in the input stream. This value is read and stored in *age*. The third variable is a real number, so the read operation expects to find a real value next on the input stream to be stored as *hourlyWage*.

The input stream may be from the keyboard or a data file, but the process is the same: The order in which the variables are listed in the input statement must be the same as the order in which the values occur in the input stream. The types of the variables being input determine how the characters in the input stream are interpreted. That is, the input stream is just a series of ASCII (or Unicode) characters. The type of the variable into which the next value is to be stored determines how a sequence of characters is interpreted. For simplicity, let's assume that the input statement believes that a blank separates each data value. For example, given the data stream

Maggie 10 12.50

"Maggie" would be stored in *name*, 10 would be stored in *age*, and 12.50 would be stored in *hourlyWage*. Both 10 and 12.50 are read in as characters and converted to type integer and real, respectively.

In a language that is not strongly typed, the format of the input determines the type. If the input appears between quotes, it is assumed to be a string and is stored that way. If the input is a number, it is stored that way.

Output statements create streams of characters. The items listed on the output statement can be literal values or variable names. Literal values are numbers or strings written explicitly in the output statement (or any statement, for that matter). The values to be output are processed one at a time by looking at the type of the identifier or literal. The type determines how the bit pattern is to be interpreted. If the type is a string, the characters are written into the output stream. If the bit pattern is a number, the number is converted to the characters that represent the digits and the characters are written out.

In a strongly typed language, regardless of the syntax of input/output statements or where the input/output streams are, the key to the processing lies in the data type that determines how characters are to be converted to a bit pattern (input) and how a bit pattern is to be converted

to characters (output). In a language that is not strongly typed, the format of the input itself determines how the bit pattern is to be converted.

Here are input and output statements in the four languages we are using for demonstrations. The prompts are omitted. The input statements are in black; the output statements are in green.

| Language | Input and Output Statements                                                                                                                                                                             |
|----------|---------------------------------------------------------------------------------------------------------------------------------------------------------------------------------------------------------|
| C++      | <pre>cin &gt;&gt; name &gt;&gt; age &gt;&gt; hourlyWage; cout &lt;&lt; name &lt;&lt; age &lt;&lt; hourlyWage;</pre>                                                                                     |
| Java     | <pre>Scanner inData; inData = new Scanner(System.in); name = inData.nextLine(); age = inData.nextInt(); hourlyWage = inData.nextFloat(); System.out.println(name, ' ',     age, ' ', hourlyWage);</pre> |
| Python   | <pre>name = input() age = input() hourlyWage = input() print name, age, hourlyWage</pre>                                                                                                                |
| VB .NET  | Uses windowing                                                                                                                                                                                          |

## Control Structures

Our pseudocode provided three ways to alter the flow of control of the algorithm: repetition, selection, and subprogram. These constructs are called **control structures** because they determine the order in which other instructions in a program are executed.

In the seminal article “Notes on Structured Programming,” published in 1972, Edsger W. Dijkstra pointed out that programmers should be precise and disciplined—in other words, they should use only selected control structures. This article and the others published with it introduced the era of *structured programming*.<sup>10</sup> According to this view, each logical unit of a program should have just one entry and one exit. The program should not jump randomly in and out of logical modules. Although programs could be designed in this way in assembly language using instructions that branch to other parts of the program, high-level languages introduced control constructs that made this discipline easy to follow. These constructs are selection statements, looping statements, and subprogram statements. With this approach, unrestricted branching statements are no longer necessary.

### Control structure

An instruction that determines the order in which other instructions in a program are executed



## Chapter 9: Object-Oriented Design and High-Level Programming Languages

In our pseudocode algorithms, we used indentation to group statements within the body of an *if* statement or a *while* statement. Python uses indentation, but the other languages use actual markers. VB .NET uses `End If` and `End While` to end the corresponding statements. Java and C++ use braces (`{}`).

The following tables show code segments using *if* and *while* statements in the demonstration languages.

| Language | <i>if</i> Statement                                                                                                                                |
|----------|----------------------------------------------------------------------------------------------------------------------------------------------------|
| Python   | <pre> if temperature &gt; 75:     print "No jacket is necessary" else:     print "A light jacket is appropriate" # Indention marks grouping </pre> |
| VB .NET  | <pre> If (Temperature &gt; 75) Then     MsgBox("No jacket is necessary") Else     MsgBox("A light jacket is appropriate") End If </pre>            |
| C++      | <pre> if (temperature &gt; 75)     cout &lt;&lt; "No jacket is necessary"; else     cout &lt;&lt; "A light jacket is appropriate"; </pre>          |
| Java     | <pre> if (temperature &gt; 75)     System.out.print("No jacket is necessary"); else     System.out.print("A light jacket is appropriate"); </pre>  |

| Language | Count-Controlled Loop with a <i>while</i> Statement                                                      |
|----------|----------------------------------------------------------------------------------------------------------|
| Python   | <pre> count = 0 while count &lt; limit:     ...     count = count + 1 # Indention marks loop body </pre> |
| VB .NET  | <pre> Count = 1 While (Count &lt;= Limit)     ...     Count = Count + 1 End While </pre>                 |
| C++/Java | <pre> count = 1; while (count &lt;= limit) {     ...     count = count + 1; } </pre>                     |

© Artur Debat/Getty Images; © Alan Dyer/Stocktrek Images/Getty Images

## Edsger Dijkstra<sup>11</sup>

Every field of human endeavor has its leading contributors who are acclaimed for their theoretical insights, extensions of fundamental ideas, or innovative changes that have redefined the subject. Edsger Dijkstra has a place reserved for him in the computer language hall of fame.

Born to a Dutch chemist in Rotterdam in 1930, Dijkstra grew up with a formalist predilection toward the world. While studying at the University of Leiden in the Netherlands, he attended a summer course on programming in Cambridge, England, and became fascinated with programming. He took a part-time job at the Mathematical Centre in Amsterdam in 1952, and he continued to work there after his graduation. Dijkstra came to the United States in the early 1970s as a research fellow for Burroughs Corporation, and in September 1984 he came to the University of Texas at Austin, where he held the Schlumberger Centennial Chair in Computer Sciences. He retired in November 1999.

One of Dijkstra's most famous contributions to programming was his strong advocacy of structured programming principles. Dijkstra observed that programs written with *goto* statements often turned into a rat's nest of jumping back and forth among disorganized, ad hoc sections of programs, making the programs difficult to understand even for their authors—not to mention the colleagues who might later be asked to maintain the program. Dijkstra strongly encouraged the use of iterative, or looping, constructs that clearly bracket the scope of branching in a program and effectively self-document the program. Dijkstra claimed that adhering to these structured programming principles would make programs far easier to understand and maintain and less likely to contain errors.

Beyond his clear theoretical contributions, Dijkstra is an interesting character in the computing world. He developed a reputation for speaking his

mind. For example, Dijkstra once remarked that “the use of COBOL cripples the mind; its teaching should therefore be regarded as a criminal offense.”

Besides his work in language design, Dijkstra is noted for his work in proofs of program correctness. The field of program correctness is an application of mathematics to computer programming in which programs can be certified as error-free. This is especially important when reliability is crucial, such as for a flight control system.

In 1972, the Association for Computing Machinery acknowledged Dijkstra's rich contributions to the field by awarding him the distinguished Turing Award.

In 1989, the Special Interest Group for Computer Science Education (SIGCSE) honored him with its award for Outstanding Contributions to Computer Science Education.

Dijkstra and his wife returned to the Netherlands when he found that he had only months to live. He had always said that he wanted to retire in Austin, Texas, but to die in the Netherlands. Dijkstra died on August 6, 2002.

Dijkstra was known for many concise and witty sayings. One that all who study computing should ponder is that “Computer science is no more about computers than astronomy is about telescopes.”



Courtesy of Staci Norman, UTCS, The University of Texas at Austin

The following table shows how VB .NET and C++ define a subprogram that does not return a single value. In this example, there are two integer value parameters and one real reference parameter. Again, this illustration is meant to give you a hint of the rich variety of syntax that abounds in high-level languages, not to make you competent in writing this construct in any of them. The ampersand (&) used in C++ is not a typographical error; it signals that `three` is a reference parameter.

| Language | Subprogram Declaration                                                                                                                               |
|----------|------------------------------------------------------------------------------------------------------------------------------------------------------|
| VB .NET  | <pre>Public Sub Example(ByVal one As Integer,                   ByVal two As Integer,                   ByRef three As Single)     ... End Sub</pre> |
| C++      | <pre>void Example(int one, int two, float&amp; three) {     ... }</pre>                                                                              |

We do not show a Java or Python example because they handle memory very differently, allowing only value parameters.

### Nested Logic

The statements to be executed or skipped in any control statement can be simple statements or blocks (compound statements)—there is no constraint on what these statements can be. In fact, the statement to be skipped or repeated can contain a control structure. Selection statements can be nested within looping structures; looping structures can be nested within selection statements. Selection and looping statements can be nested within subprograms, and subprogram calls can be nested within looping or selection structures.

We have looked at nesting in our algorithms, but the topic is worth another look. Take, for example, the algorithm that counts and sums ten positive numbers in a file:

```

Set sum to 0 // Initialize sum
Set posCount to 0 // Initialize event
WHILE (posCount < 10) // Test event
 Read a value
 IF (value > 0) // Test to see if event should be updated
 Set posCount to posCount + 1 // Update event
 Set sum to sum + value // Add value into sum
// Statement(s) following loop

```

The selection control structure is embedded within a looping control structure. If we wanted to sum and print weekly rainfall figures for a year, we would have the following nested looping structures:

```

Set weekCount to 1
WHILE (weekCount <= 52)
 Set weekSum to 0
 Set dayCount to 1
 WHILE (dayCount <= 7)
 Read rainfall
 Set weekSum to weekSum + rainfall
 Set dayCount to dayCount + 1
 Write "Week ", weekCount, " total: ", weekSum
 Set weekCount to weekCount + 1

```

Control structures within control structures within control structures . . . Theoretically, there is no limit to how deeply control structures can be nested! However, if the nesting becomes too difficult to follow, you should give the nested task a name and make it a subprogram, giving its implementation later. For example, examine the alternative version of the preceding pseudocode algorithm. Which is easier to follow?

### Should programmers read philosophy?

A 2014 letter to the editor in *The Wall Street Journal* argued that "Computer programming and software design are essentially highly structured philosophy addressing a particular aspect of the world. Philosophers would benefit from reading some books on programming, and programmers would benefit from reading some books on philosophy."<sup>12</sup>

© Artur Debat/Getty Images, © Alan Dyer/Stocktrek Images/Getty Images

```

Set weekCount to 1
WHILE (weekCount <= 52)
 Set weekSum to CalculateWeekSum(weekCount)
 Write "Week ", weekCount, " total: ", weekSum
 Set weekCount to weekCount + 1

```

© Artur Debat/Getty Images, © Alan Dyer/Stocktrek Images/Getty Images

### CalculateWeekSum(weekCount)

```

Set weekSum to 0
Set dayCount to 1
WHILE (dayCount <= 7)
 Read rainfall
 Set weekSum to weekSum + rainfall
 Set dayCount to dayCount + 1
RETURN weekSum

```

## Asynchronous Processing

You have likely grown up using a graphical user interface (GUI) that relies on the use of a mouse to manipulate multiple window frames on a screen. *Clicking* has become a major form of input to the computer. In fact, for many applications, filling in boxes and clicking buttons to say the input is ready has become the only form of input.

In traditional stream processing, an input statement is executed in the sequence in which it is encountered. Here are the first four statements in the algorithm shown earlier:

© Artur Debat/Getty Images, © Alan Dyer/Stocktrek Images/Getty Images

```

Write "How many pairs of values are to be entered?"
Read numberOfPairs
Set numberRead to 0
WHILE (numberRead < numberOfPairs)


```

We expect these statements to be executed in sequence. Output is written to a window, a value is read from the input stream, another value is stored, and the *while* loop is executed. Stream input and output is within the sequential flow of the program.

Mouse clicking, in contrast, does not occur within the sequence of the program. That is, a user can click a mouse at any time during the execution of a program. The program must recognize when a mouse click has occurred, process the mouse click, and then continue. This type of processing is called **asynchronous**, which means “not at the same time.” The mouse can be clicked at any time; it is not synchronized with any other instructions.

Asynchronous processing is also called *event-driven* processing. In other words, the processing is under the control of events happening outside the sequence of program instructions.

Asynchronous processing is used frequently in Java and VB .NET but less often in the other languages.

#### Asynchronous

Not occurring at the same moment in time as some specific operation of the computer; in other words, not synchronized with the program's actions

## 9.5 Functionality of Object-Oriented Languages

As you might guess from the earlier discussion of object-oriented design, the basic construct in an object-oriented language is the *class*. In addition to looking at the class construct in this section, we examine the three essential ingredients in an object-oriented language: *encapsulation*, *inheritance*, and *polymorphism*. These ingredients foster reuse, thereby reducing the cost of building and maintaining software.

### Encapsulation

In Chapter 7, we talked about important threads running through the discussion of problem solving. Two of these threads were *information hiding* and *abstraction*. Recall that information hiding is the practice of hiding the details of a module with the goal of controlling access to the details. We said in Chapter 7 that abstraction was a model of a complex system

**Encapsulation (second definition)** A language feature that enforces information hiding

**Object (problem-solving phase)** An entity or thing that is relevant in the context of a problem

**Class (implementation phase)** A pattern for an object

**Object class (class) (problem-solving phase)** A description of a group of objects with similar properties and behaviors

**Object (implementation phase)** An instance of a class

that includes only the details essential to the viewer. We defined three types of abstraction, but the definitions of each began and ended with the words “The separation of the logical view of . . . from its implementation details.” Abstraction is the goal; information hiding is a technique used to achieve the goal.

In the discussion of object-oriented design, we said that encapsulation is the bundling of data and actions in such a way that the logical properties of the data and actions remain separate from the implementation details. Another way of saying this is that **encapsulation** is a language feature that enforces information hiding. A module’s implementation is hidden in a separate block with a formally specified interface. An object knows things about itself, but not about any other object. If one object needs information about another object, it must request that information from that object.

The construct used to provide encapsulation is the class. Just as the concept of the class dominates object-oriented design, so the class concept is the major feature of Java and other object-oriented languages. Unfortunately, the related definitions are not standard across the phases of design and implementation. In the design (problem-solving) phase, an **object** is a thing or entity that makes sense within the context of the problem. In the implementation phase, a **class** is a language construct that is a pattern for an object and provides a mechanism for encapsulating the properties and actions of the object class.

## Classes

Syntactically, a class is like a record in that it is a heterogeneous composite data type. However, records have traditionally been considered passive structures; only in recent years have they had subprograms as fields. The class, by contrast, is an active structure and almost always has subprograms as fields. The only way to manipulate the data fields of a class is through the methods (subprograms) defined in the class.

Here is how we might define class *Person*, based on one developed earlier:

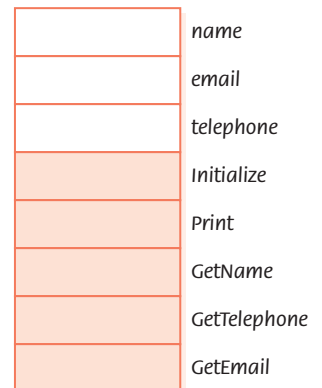
```
public class Person
 // Class variables
 Name name
 String telephone
 String email
 // Class Methods
 Initialize()
 // Code for Initialize
 public Print()
 // Code for Print
 public Name GetName()
 RETURN Name
 public String GetEmail()
 RETURN email
 public String GetTelephone()
 RETURN telephone
```

**Instantiate** To create an object from a class

**FIGURE 9.4** visualizes class *Person*. The variable fields are blank. The subprograms are orange to indicate that they do not contain values but are subprograms.

In our algorithms, we have used identifiers for simple variables and arrays without worrying about where they come from. If we use an identifier to represent a class, however, we must explicitly ask for the class to be created before we can use it. That is, we have to **instantiate** the class by using the *new* operator to get an object that fits the pattern. This operator takes the class name and returns an instance of the class. This algorithm instantiates a class *Person*, gets an object *aPerson* of the class, and stores and retrieves values in the object. We first instantiate a *Name* object but assume that string variables *email* and *telephone* already have values.

Person



**FIGURE 9.4** Class *Person*



```

Name aName = new Name()
aName.Initialize("Frank", "Jones")
Person aPerson = new Person()
aPerson.Initialize(aName, telephone, email)
aPerson.Print()
Write "Name: ", aPerson.GetName().Print()
Write "Telephone: ", aPerson.GetTelephone()
Write "Email: ", aPerson.GetEmail()

```

The algorithms that declare class objects can access the fields of the class only through the subprograms (called *methods*) of the class.

The fields in a class are private by default. That is, none of the fields, either data or method, of an object of a particular class can be accessed by any other object unless the field is marked *public*. If a class needs to make a method available to be called by an object of another class, the class must explicitly specify that the method is *public*. The *Person* class methods are marked *public* so that a using program can call them.

## Inheritance

**Inheritance** A mechanism by which one class acquires the properties—data fields and methods—of another class

**Inheritance** is a property of object-oriented languages in which classes can inherit data and methods from other classes. This relationship is an “is-a” relationship. A *superclass* is a class being inherited from; a *derived class* is a class doing the inheriting. Classes form an inheritance hierarchy. In the hierarchy, objects become more specialized the lower in the hierarchy we go. Classes farther down in the hierarchy inherit all of the behaviors and data of their parent superclass.

In our latest example, we have been working with class *Person*. In an object-oriented language, we can define a class *Student*, which inherits all the properties of class *Person* and adds more data fields to hold the local *address* and *telephone* number. Objects of class *Person* have only one address and phone number, but objects of class *Student* have two: one inherited from class *Person* and one defined within class *Student*. We say that class *Student* is derived from class *Person*.

Here are the CRC card headings for *Person* and *Student*. Note that the Subclass and Superclass fields in the CRC cards have been filled in.

Class Name: *Person*

Superclass:

Subclasses: *Student*Class Name: *Student*Superclass: *Person*

Subclasses:

Let's assume that we have defined classes *Person* and *Student*. The following algorithm instantiates classes *Person* and *Student* and manipulates them:

```

Person myPerson = new Person() // Instantiates myPerson
Student myStudent = new Student() // Instantiates myStudent
myPerson.Initialize(...) // myPerson initializes itself
myStudent.Initialize(...) // myStudent initializes itself
myPerson.Print() // myPerson prints itself
myStudent.Print() // myStudent prints itself

```

Inheritance fosters reuse by allowing an application to take an already-tested class and derive a class from it that inherits the properties the application needs. Other necessary properties and methods can then be added to the derived class.

## Polymorphism

In the previous section, classes *Person* and *Student* both have methods named *Print* and *Initialize*. The method in class *Person* prints the address defined in its class, and the method in class *Student* prints the address defined in its class. Here we have two methods with the same name but different implementations. The ability of a programming language to handle this apparent ambiguity is called **polymorphism**. How does the language know which method is meant when *Initialize* or *Print* is invoked by the calling unit? Methods that are part of a class are applied to an instance of the class by the calling unit. The class of object to which the method is applied determines which versions of the *Initialize* or *Print* method are used.

For example, if we had *jane* as an instance of class *Person* and *jack* as an instance of class *Student*, *jane.Print* would invoke the method defined in class *Person* to print *jane's* information. *jack.Print* would invoke the method defined in class *Student* to print *jack's* information. The *Student* class could add a method *PrintHomeAddress*, which would then print the home address of a student.

### Report software piracy

?

If you know of an incidence of software piracy, fill out a report online at [www.bsa.org](http://www.bsa.org) and you may be eligible for a reward.

**Polymorphism** The ability of a language to determine at runtime which of several possible methods will be executed for a given invocation

The combination of inheritance and polymorphism allows the programmer to build useful hierarchies of classes that can be reused in different applications. Reuse does not apply only to object-oriented languages; however, the functionality of object-oriented languages makes writing general, reusable sections of code easier.

## 9.6 Comparison of Procedural and Object-Oriented Designs

At the end of Chapter 8, we used the implementation of List ADT algorithms to describe the process of value-returning and non-value-returning subprograms. The implementation of the List ADT was a record variable *list*, which contained an array *values* and a *length* field, that was passed to the List algorithms to be acted upon. The calling program defined the implementation of the list and wrote the algorithms to manipulate it. The subprograms were tasks of the program that needed a list.

In an object-oriented design, the List data structure and subprograms would be bound together in a class as follows:

```
public class List
 // Class variables
 values[]
 length
 // Class methods
 public Boolean IsThere(item)
 Set position to 0
 WHILE (position < length AND
 values[position] != item)
 Set position to position + 1
 RETURN position < length
 public Delete(item)
 Set position to 1
 WHILE (values[position] != item)
 Set position to position + 1
 Swap(values[length - 1], values[position])
 Set length to length - 1
 // Rest of class operations
```

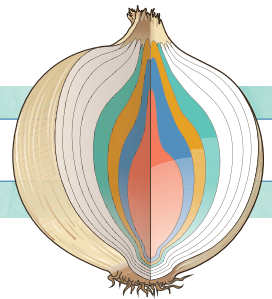
The code of the methods has direct access to the class variables; the user's code does not. The class would be compiled separately and the program that wanted to use the class would include it in its program. Here is a segment of pseudocode that would manipulate a `List` object:

```

List list = new List() // Instantiate List object
WHILE (more values)
 Read aValue
 IF (NOT list.IsThere(aValue))
 list.insert(aValue)
Write "Input value to delete or "Quit" to quit"
Read aValue
IF (aValue != "Quit")
 IF (list.IsThere(aValue))
 list.Delete(aValue)

```

In the procedural version, the list is represented by a record that is passed to the subprograms that operate on it. The data structure and the subprograms that manipulate it are part of the user's program. In the object-oriented version, the implementation of a class object is hidden from the user through encapsulation.



© Artur Debat/Getty Images, © Alan Dyer/Stocktrek Images/Getty Images

## SUMMARY

Object-oriented design focuses on determining the objects within a problem and abstracting (grouping) those objects into classes based on like properties and behaviors. There are four stages to object-oriented decomposition:

- Brainstorming, in which we make a first pass at determining the classes in the problem
- Filtering, in which we review the proposed classes
- Scenarios, in which the responsibilities of each class are determined
- Responsibility algorithms, in which the algorithms are written for each of the responsibilities

An assembler translates an assembly-language program into machine code. A compiler translates a program written in a high-level language either into assembly language (to be later translated into machine code) or into machine code. An interpreter is a program that translates the instructions in a program and executes them immediately. An interpreter does not output machine-language code.

Various models of high-level programming languages exist, classified as either imperative (procedural and object-oriented) or declarative (functional and logic). The imperative model describes the processing to be done. The declarative model describes what is to be done, not how it is to be accomplished. The procedural model is based on the concept of a hierarchy of tasks to be completed; the object-oriented model is based on the concept of interacting objects. The functional model is based on the mathematical concept of a function; the logic model is based on mathematical logic.

A Boolean expression is an assertion about the state of a program. Boolean expressions are used to allow a program to execute one section of code or another (conditional statements) and to repeat a section of code (looping statements).

Each variable in a program is a certain data type. Strong typing means that variables are given a type and that only values of that data type can be stored into the variable. Storing a value into a variable is called *assigning* the value to the variable (assignment statements).

Object-oriented programs are characterized by the following constructs:

- *Encapsulation*, a language feature that enforces information hiding that is implemented using the class construct
- *Inheritance*, a language feature that allows one class to inherit the properties and behaviors of another class
- *Polymorphism*, the ability of a language to disambiguate between operations with the same name



## ETHICAL ISSUES

### Hoaxes and Scams

There have always been scammers, con artists, and hoaxers. There have always been people ready to be taken advantage of. Hoaxes are usually harmless, while a scam is aimed to make money. The motives of a hoaxer are sometimes difficult to discern and may be as simple as the adolescent's impulse "to leave a mark" or create a hoax "just for kicks." Hoaxes are annoying and time-consuming. The ultimate motive of the con artist and scammer, however, is to trick the naïve and unwary out of their money or possessions.

For example, the Free Doritos Coupons Hoax sent email that said the attached file contained coupons for \$5 worth of Doritos products. The coupons were fake and were not honored by Doritos. The results were annoying, but no one lost any money. Chain letters asking the receiver to send some sort of message to all their friends is usually a hoax; no money is requested. On the other hand, the emails that say the recipient has won a lottery and must send a check for the handling fee are a scam. There is no lottery and no winner except the scammer, who receives a check for the so-called "handling fee."<sup>13</sup>

Before computers, the pool of potential victims for these con artists was limited.

Then came the Internet. With a few clicks of a mouse, a scammer can now reach thousands of potential victims through email. The gathering of email addresses can be automated, which creates an enormous population of potential victims. Websites can act as virtual spider webs, entrapping those who innocently wander in.

There was a time when the most common complaint of Internet users was the annoyance of commercial spam. Today, good email services provide filters that catch most commercial spam before it reaches the individual. The most common complaints today relate to scammers, not spammers. Internet auctions, credit card fraud, third-party and creditor debt collection, foreign money offers and counterfeit check scams, travel and vacation scams, and bogus business opportunities/investments are at the top of the list.<sup>14</sup>

The most serious crimes are those that steal financial information and passwords from web surfers. Websites can lull people into believing they are responding to a survey or providing credit card information as proof of age. With passwords, criminals can gain access to all their victims' financial records. Identity theft is devastating to the victims and it can take years for the victims to recover. Perhaps the greatest threat



## ETHICAL ISSUES

### Hoaxes and Scams (CONTINUED)

comes from those who really want to wreak havoc. Today, airlines, banks, and municipal infrastructures are all tied into computer networks. The damage a determined cyber-criminal can cause is boundless.

Policing these schemes can be very difficult and very expensive. Perpetrators disguise not only their identities, but also their geographical locations. For now, the best protection users have is skepticism. Refuse to give out credit card or other personal information to any request.

An example of a scam email sent to Nell Dale:

*IT Department Service,  
You have exceeded the limit of your mailbox set  
by your IT Department service. And you will be*

*having problems in sending and receiving new  
emails. To prevent this, you will have to contact  
the IT Department Service by email with your:*

*Current username:{ } and  
Password:{ } to help increase your storage  
limit.*

*IT Department Service*

*E-mail: <mailto:it.dept@administrativos.  
com>it.dept@administrativos.com*

*Failure to do this, will result in limited access  
to your mailbox.*

*Regards,*

*IT Department Service*

Would you have answered? What would have happened if you had?

© Artur Debat/Getty Images; © Alan Dyer/Stocktrek Images/Getty Images

## KEY TERMS

Asynchronous

Boolean expression

Bytecode

Case sensitive

Class (implementation phase)

Compiler

Control structure

Data type

Declaration

Encapsulation

Fields

Inheritance

Instantiate

Interpreter

Method

Object

**KEY TERMS (CONTINUED)**

|                                              |               |
|----------------------------------------------|---------------|
| Object (implementation phase)                | Polymorphism  |
| Object (problem-solving phase)               | Reserved word |
| Object class (class)                         | Strong typing |
| Object class (class) (problem-solving phase) |               |

**EXERCISES**

For Exercises 1–10, match the activity with the phase of the object-oriented methodology.

- A. Brainstorming
  - B. Filtering
  - C. Scenarios
  - D. Responsibility algorithms
1. Reviewing a list of possible classes, looking for duplicates or missing classes
  2. Asking “what if” questions
  3. Assigning responsibilities to classes
  4. Generating a first approximation to the list of classes in a problem
  5. Assigning collaborators to a responsibility
  6. Developing algorithms for the responsibilities listed on a CRC card
  7. Output from this phase is a fully developed CRC card for all classes

8. Output from this phase is the design ready to be translated into a program
9. During this phase, inheritance relationships are established
10. Phase in which functional programming techniques are appropriate

For Exercises 11–24, match the question with the appropriate translation or execution system.

- A. Interpreter
  - B. Assembler
  - C. Compiler
  - D. Machine code
11. What translates a high-level language into machine code?
  12. What translates a Java program into Bytecode?
  13. What executes Bytecode?
  14. What translates an assembly-language program?



**EXERCISES (CONTINUED)**

15. What is the output of an assembler?
  16. What takes input in a high-level language and directs the computer to perform the actions specified in each statement?
  17. What executes the Java Virtual Machine?
  18. What is used to translate a program in ALGOL?
  19. What is used to translate a program in APL?
  20. What is used to translate a program in COBOL?
  21. What is used to translate a program in FORTRAN?
  22. What is used to translate a program in Lisp?
  23. What is used to translate a program in Prolog?
  24. Which translator runs the most slowly?
- For Exercises 25–46, match the language paradigm and the language or the language description.
- A. Procedural
  - B. Functional
  - C. Logic
  - D. Object oriented
  - E. Procedural language with object-oriented features
  - F. Object-oriented language with some procedural features
25. Which paradigm most accurately describes FORTRAN?
  26. Which paradigm most accurately describes C++?
  27. Which paradigm most accurately describes PASCAL?
  28. Which paradigm most accurately describes Java?
  29. Which paradigm most accurately describes Lisp?
  30. Which paradigm most accurately describes BASIC?
  31. Which paradigm most accurately describes Prolog?
  32. Which paradigm most accurately describes SIMULA?
  33. Which paradigm most accurately describes ALGOL?
  34. Which paradigm most accurately describes ML?
  35. Which paradigm most accurately describes Scheme?
  36. Which paradigm most accurately describes Python?
  37. Which paradigm most accurately describes C?
  38. Which paradigm most accurately describes Smalltalk?
  39. The dominant languages used in industry throughout the history of computing software come from which paradigm?
  40. Which paradigm did Japanese researchers choose for the fifth-generation computer?

**EXERCISES (CONTINUED)**

41. Which paradigm allows the programmer to express algorithms as a hierarchy of objects?
  42. Which paradigm allows the programmer to express algorithms as a hierarchy of tasks?
  43. Which paradigm allows the programmer to express algorithms as mathematical functions?
  44. Which paradigm has no assignment statement?
  45. Which paradigm uses recursion exclusively to express repetition?
  46. Which paradigm has no variables?
- Exercises 47–84 are problems or short-answer questions.
47. What is the hallmark of an assembly language?
  48. Distinguish between an assembler and a compiler.
  49. Distinguish between a compiler and an interpreter.
  50. Compare and contrast an assembler, a compiler, and an interpreter.
  51. Describe the portability provided by a compiler.
  52. Describe the portability provided by the use of Bytecode.
  53. Describe the process of compiling and running a Java program.
  54. Discuss the word *paradigm* as it relates to computing.
  55. Distinguish between imperative and declarative paradigms.
  56. What are the characteristics of the imperative paradigm?
  57. What are the characteristics of the functional paradigm?
  58. What are the characteristics of the logic paradigm?
  59. What are the characteristics of a declarative paradigm?
  60. How do you ask questions in a programming language?
  61. What is a Boolean variable?
  62. What is a Boolean expression?
  63. Given variables *one*, *two*, and *three*, write an assertion for each of the following questions.
    - a. Is *one* greater than both *two* and *three*?
    - b. Is *one* greater than *two*, but less than *three*?
    - c. Are all three variables greater than zero?
    - d. Is *one* less than *two* or is *one* less than *three*?
    - e. Is *two* greater than *one* and is *three* less than *two*?
  64. Write the operation table for the Boolean operation AND.
  65. Write the operation table for the Boolean operation OR.
  66. Write the operation table for the Boolean operation NOT.

## EXERCISES (CONTINUED)

67. What is a data type?
68. What is strong typing?
69. Define the following data types.
  - a. Integer
  - b. Real
  - c. Character
  - d. Boolean
70. Is the string data type an atomic data type? Justify your answer.
71. If the same symbol is used for both single characters and strings, how can you distinguish between a single character and a one-character string?
72. What is a declaration?
73. Fill in the following table, showing the appropriate syntactic marker or reserved word for the language shown based on your observations of the tables in this chapter.
74. How do the `.WORD` and `.BLOCK` assembler directives in the Pep/9 assembly language differ from the declarations in high-level languages?
75. Distinguish between instructions to be translated and instructions to the translating program.
76. Consider the following identifiers: `Address`, `ADDRESS`, `AddRes`, `Name`, `NAME`, `NamE`.
  - a. How many different identifiers are represented if the language is Python?
  - b. How many different identifiers are represented if the language is VB .NET?
  - c. How many different identifiers are represented if the language is C++ or Java?

| Language                    | Python | VB .NET | C++ | Java |
|-----------------------------|--------|---------|-----|------|
| Comments                    |        |         |     |      |
| End of statement            |        |         |     |      |
| Assignment statement        |        |         |     |      |
| Real data type              |        |         |     |      |
| Integer data type           |        |         |     |      |
| Beginning of declaration(s) |        |         |     |      |

**EXERCISES (CONTINUED)**

77. Distinguish between the definition of an object in the design phase and in the implementation phase.
78. Distinguish between the definition of a class in the design phase and in the implementation phase.
79. Distinguish between a field and a method.
80. How can objects relate to one another?
81. Discuss the differences between a top-down design and an object-oriented design.
82. In this chapter, we outlined a strategy for developing an object-oriented decomposition.
  - a. List the four stages.
  - b. Outline the characteristics of each stage.
    - c. What is the output from each of the four stages?
    - d. Are each of the stages independent? Explain.
83. Design the CRC cards for an inventory system for a car dealership, using brainstorming, filtering, and scenarios.
84. Design the CRC cards for a database for a zoo, using brainstorming, filtering, and scenarios.

**THOUGHT QUESTIONS**

1. Distinguish between a program that the CPU can execute directly and a program that must be translated.
2. Top-down design and object-oriented design both create scaffolding that is used to write a program. Is all of this scaffolding just a waste of effort? Is it ever used again? Of what value is it after the program is up and running?
3. Which of the problem-solving strategies do you use the most? Can you think of some others that you use? Would they be appropriate for computing problem-solving?
4. Have you ever been taken in by a hoax? Were you angry or just annoyed?
5. Have you or anyone you know been the victim of a scam artist?
6. Have you ever received an email similar to the one shown in this chapter? Did you respond?

## Laying the Groundwork

- 1 The Big Picture

## The Information Layer

- 2 Binary Values and Number Systems
- 3 Data Representation

## The Hardware Layer

- 4 Gates and Circuits
- 5 Computing Components

## The Programming Layer

- 6 Low-Level Programming Languages and Pseudocode
- 7 Problem Solving and Algorithms
- 8 Abstract Data Types and Subprograms
- 9 Object-Oriented Design and High-Level Programming Languages

## The Operating Systems Layer

- 10 Operating Systems
- 11 File Systems and Directories

## The Applications Layer

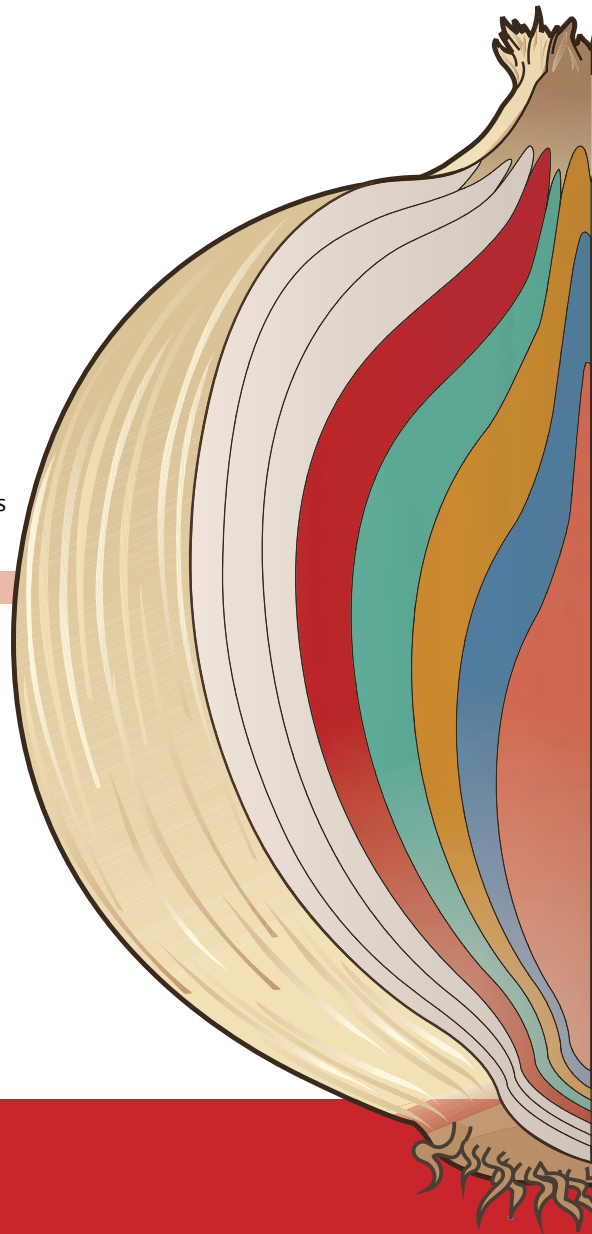
- 12 Information Systems
- 13 Artificial Intelligence
- 14 Simulation, Graphics, Gaming, and Other Applications

## The Communications Layer

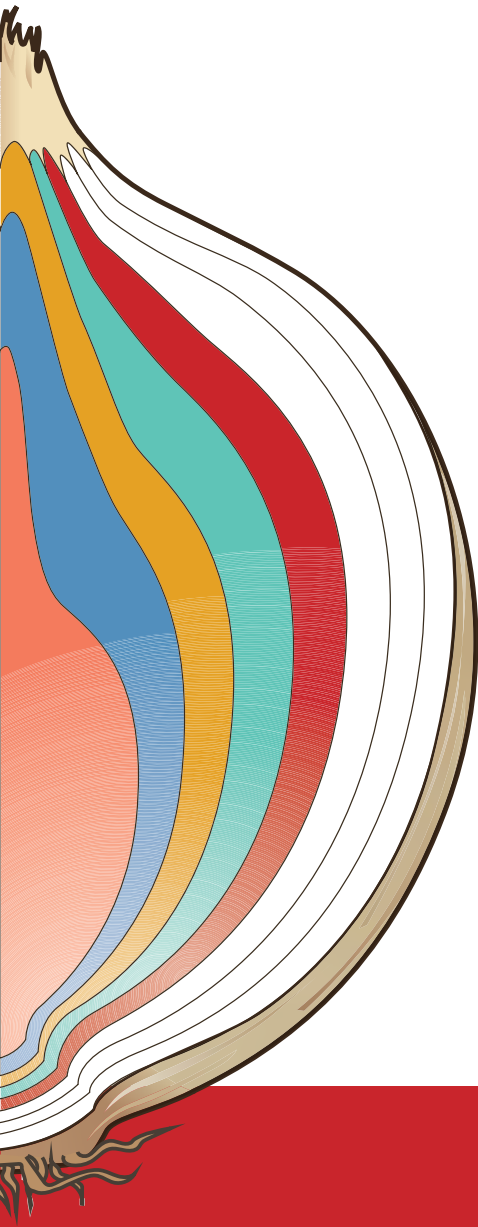
- 15 Networks
- 16 The World Wide Web
- 17 Computer Security

## In Conclusion

- 18 Limitations of Computing



# THE OPERATING SYSTEMS LAYER



## 10

# OPERATING SYSTEMS

To understand a computer system, you must understand the software that manages and coordinates its pieces. The operating system of a computer is the glue that holds the hardware and software together. It is the software foundation on which all other software rests, allowing us to write programs that interact with the machine. This chapter and the next one explore the way in which an operating system manages computer resources. Just as a policeman organizes the efficient flow of cars through an intersection, an operating system organizes the efficient flow of programs through a computer system.

## GOALS

After studying this chapter, you should be able to:

- describe the two main responsibilities of an operating system.
- define memory and process management.
- explain how timesharing creates the virtual machine illusion.
- explain the relationship between logical and physical addresses.
- compare and contrast memory management techniques.
- distinguish between fixed and dynamic partitions.
- define and apply partition selection algorithms.
- explain how demand paging creates the virtual memory illusion.
- explain the stages and transitions of the process life cycle.
- explain the processing of various CPU-scheduling algorithms.

## 10.1 Roles of an Operating System

### Application software

Programs that help us solve real-world problems

### System software

Programs that manage a computer system and interact with hardware

### Operating system

System software that manages computer resources and provides an interface for system interaction

In Chapter 1, we talked about the changing role of the programmer. As early as the end of the first generation of software development, there was a split between those programmers who wrote tools to help other programmers and those who used the tools to solve problems. Modern software can be divided into two categories, application software and system software, reflecting this separation of goals. **Application software** is written to address specific needs—to solve problems in the real world. Word processing programs, games, inventory control systems, automobile diagnostic programs, and missile guidance programs are all application software. Chapters 12 through 14 discuss areas of computer science that relate to application software.

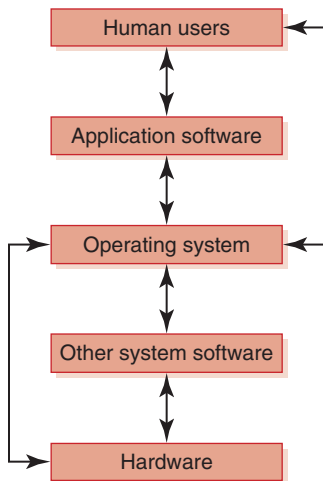
**System software** manages a computer system at a more fundamental level. It provides the tools and an environment in which application software can be created and run. System software often interacts directly with the hardware and provides more functionality than the hardware itself does.

The **operating system** of a computer is the core of its system software. An operating system manages computer resources, such as memory and input/output devices, and provides an interface through which a human can interact with the computer. Other system software supports specific application goals, such as a library of graphics software that renders images on a display. The operating system allows an application program to interact with these other system resources.

**FIGURE 10.1** shows the operating system in its relative position among computer system elements. The operating system manages hardware resources. It allows application software to access system resources, either directly or through other system software. It provides a direct user interface to the computer system.

A computer generally has one operating system that becomes active and takes control when the system is turned on. Computer hardware is wired to initially load a small set of system instructions that is stored in permanent memory (ROM). These instructions load a larger portion of system software from secondary memory, usually a magnetic disk. Eventually all key elements of the operating system software are loaded, start-up programs are executed, the user interface is activated, and the system is ready for use. This activity is often called *booting* the computer. The term “boot” comes from the idea of “pulling yourself up by your own bootstraps,” which is essentially what a computer does when it is turned on.

A computer could have two or more operating systems from which the user chooses when the computer is turned on. This configuration



**FIGURE 10.1** An operating system interacts with many aspects of a computer system



is often called a *dual-boot* or *multi-boot* system. Only one operating system controls the computer at any given time, however.

You've likely used at least one operating system before. The various versions of Microsoft® Windows are popular choices for personal computers. The different versions of these operating systems indicate how the software evolves over time, as well as how changes occur in the way services are provided and managed. The Mac OS family is the operating system used on computers manufactured by Apple Computer. UNIX has been a favorite of serious programmers for years, and a version of UNIX called *Linux* is popular for personal computer systems.

Mobile devices, such as smartphones and tablet computers, run operating systems that are tailored to their needs. The memory constraints and the smaller set of peripherals involved, for example, are different than those of a typical desktop or laptop computer. Apple Computer's iPhone (shown in [FIGURE 10.2](#)), iPad, and iPod all run the iOS mobile operating system, which is derived from Mac OS. The Android operating system, developed by Google as an open-source project through the Open Handset Alliance, is the underlying system run on a variety of phones, and has become the most popular platform for mobile devices. Android and iOS dominate the current market for mobile operating systems, though there are still several others.



**FIGURE 10.2** Smartphones and other mobile devices run operating systems tailored for them

© Hemera/Thinkstock

### Who is Blake Ross?

?

Blake Ross was designing web pages by the age of 10. By 14, he was fixing bugs in Netscape's web browser as a hobby. Before finishing high school, he helped develop Firefox, which was officially released in November 2004. While in college, Ross continued fixing bugs in the browser. In 2005, he was nominated for *Wired* magazine's Renegade of the Year award. He was Facebook's product director until he resigned in 2013 at age 29. With a net worth of \$150 million, he never needs to work again.



Any given operating system manages resources in its own particular way. Our goal in this chapter is not to nitpick about the differences among operating systems, but rather to discuss the ideas common to all of them. We occasionally refer to the methods that a specific OS (operating system) uses, and we discuss some of their individual philosophies. In general, however, we focus on the underlying concepts.

The various roles of an operating system generally revolve around the idea of “sharing nicely.” An operating system manages resources, and these resources are often shared in one way or another among the various programs that want to use them. Multiple programs executing concurrently share the use of main memory. They take turns using the CPU. They compete for an opportunity to use input/output devices. The operating system acts as the playground monitor, making sure that everyone cooperates and gets a chance to play.

### Multiprogramming

The technique of keeping multiple programs in main memory at the same time, competing for the CPU

### Memory

**management** The act of keeping track of how and where programs are loaded in main memory

**Process** The dynamic representation of a program during execution

### Process management

The act of keeping track of information for active processes

### CPU scheduling

The act of determining which process in memory is given access to the CPU so that it may execute

## Memory, Process, and CPU Management

Recall from Chapter 5 that an executing program resides in main memory and its instructions are processed one after another in the fetch–decode–execute cycle. **Multiprogramming** is the technique of keeping multiple programs in main memory at the same time; these programs compete for access to the CPU so that they can do their work. All modern operating systems employ multiprogramming to one degree or another. An operating system must therefore perform **memory management** to keep track of which programs are in memory and where in memory they reside.

Another key operating system concept is the idea of a **process**, which can be defined as a program in execution. A program is a static set of instructions. A process is the dynamic entity that represents the program while it is being executed. Through multiprogramming, a computer system might have many active processes at once. The operating system must manage these processes carefully. At any point in time, a specific instruction may be the next to be executed. Intermediate values have been calculated. A process might be interrupted during its execution, so the operating system performs **process management** to carefully track the progress of a process and all of its intermediate states.

Related to the ideas of memory management and process management is the need for **CPU scheduling**, which determines which process in memory is executed by the CPU at any given point.

Memory management, process management, and CPU scheduling are the three main topics discussed in this chapter. Other key operating system topics, such as file management and secondary storage, are covered in Chapter 11.

Keep in mind that the OS is itself just a program that must be executed. Operating system processes must be managed and maintained in main memory along with other system software and application programs. The OS executes on the same CPU as the other programs, and it must take its turn among them.

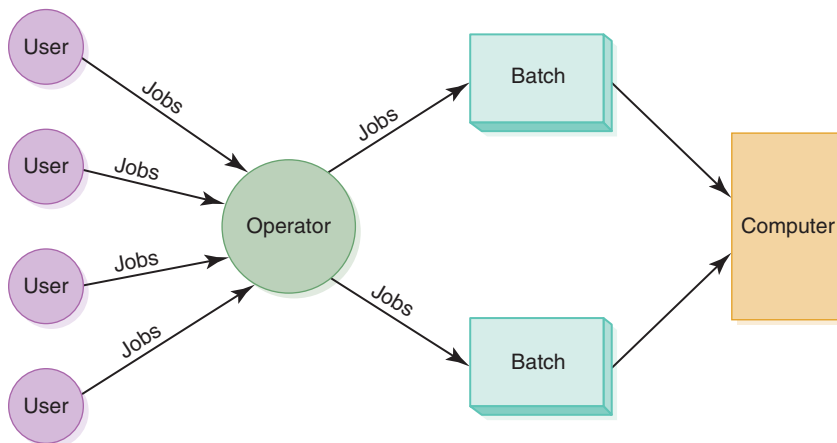
Before we delve into the details of managing resources such as main memory and the CPU, we need to explore a few more general concepts.

## Batch Processing

A typical computer in the 1960s and 1970s was a large machine stored in its own frigidly air-conditioned room. Its processing was managed by a human *operator*. A user would deliver his or her program, usually stored as a deck of punched cards, to the operator to be executed. The user would come back later—perhaps the next day—to retrieve the printed results.

When delivering the program, the user would also provide a set of separate instructions regarding the system software and other resources needed to execute the program. Together the program and the system instructions were called a *job*. The operator would make any necessary devices available and load any special system software required to satisfy the job. Obviously, the process of preparing a program for execution on these early machines was quite time consuming.

To perform this procedure more efficiently, the operator would organize various jobs from multiple users into batches. A batch would contain a set of jobs that needed the same or similar resources. With batch processing, the operator did not have to reload and prepare the same resources over and over. **FIGURE 10.3** depicts this procedure.



**FIGURE 10.3** In early systems, human operators would organize jobs into batches

Batch systems could be executed in a multiprogramming environment. In that case, the operator would load multiple jobs from the same batch into memory, and these jobs would compete for the use of the CPU and other shared resources. As the resources became available, the jobs would be scheduled to use the CPU.

Although the original concept of batch processing is not a function of modern operating systems, the terminology persists. The term “batch” has come to mean a system in which programs and system resources are coordinated and executed without interaction between the user and the program. Modern operating systems incorporate batch-style processing by allowing the user to define a set of OS commands as a batch file to control the processing of a large program or a set of interacting programs. For example, files with the extension `.bat` in Microsoft Windows originated from the idea of batch control files; they contain system commands.

Although most of our computer use these days is interactive, some jobs still lend themselves to batch processing. For example, processing a corporation’s monthly payroll is a large job that uses specific resources with essentially no human interaction.

Early batch processing allowed multiple users to share a single computer. Although the emphasis has changed over time, batch systems taught us valuable lessons about resource management. The human operator of early computer systems played many of the roles that modern operating system software handles now.

## Timesharing

As we mentioned in Chapter 1, the problem of how to capitalize on computers’ greater capabilities and speed led to the concept of *timesharing*. A **timesharing** system allows multiple users to interact with a computer at the same time. Multiprogramming allowed multiple processes to be active at once, which gave rise to the ability for programmers to interact with the computer system directly, while still sharing its resources.

Timesharing systems create the illusion that each user has exclusive access to the computer. That is, each user does not have to actively compete for resources, though that is exactly what is happening behind the scenes. One user may actually know he is sharing the machine with other users, but he does not have to do anything special to allow it. The operating system manages the sharing of the resources, including the CPU, behind the scenes.

The word *virtual* means “in effect, though not in essence.” In a timesharing system, each user has his or her own **virtual machine**, in which all

**Timesharing** A system in which CPU time is shared among multiple interactive users at the same time

**Virtual machine** The illusion created by a timesharing system that each user has a dedicated machine

system resources are (in effect) available for use. In essence, however, the resources are shared among many such users.

Originally, timesharing systems consisted of a single computer, often called the **mainframe**, and a set of dumb terminals connected to the mainframe. A **dumb terminal** is essentially just a monitor display and a keyboard. A user sits at a terminal and “logs in” to the mainframe. The dumb terminals might be spread throughout a building, with the mainframe residing in its own dedicated room. The operating system resides on the mainframe, and all processing occurs there.

Each user is represented by a *login process* that runs on the mainframe. When the user runs a program, another process is created (spawned by the user’s login process). CPU time is shared among all of the processes created by all of the users. Each process is given a little bit of CPU time in turn. The premise is that the CPU is so fast that it can handle the needs of multiple users without any one user seeing any delay in processing. In truth, users of a timesharing system can sometimes see degradation in the system’s responses, depending on the number of active users and the CPU’s capabilities. That is, each user’s machine seems to slow down when the system becomes overburdened.

Although mainframe computers are interesting now mostly for historical reasons, the concept of timesharing remains highly relevant. Today, many desktop computers run operating systems that support multiple users in a timesharing fashion. Although only one user is actually sitting in front of the computer, other users can connect through other computers across a network connection.

## Other OS Factors

As computing technology improved, the machines themselves got smaller. Mainframe computers gave rise to *minicomputers*, which no longer needed dedicated rooms to store them. Minicomputers became the basic hardware platform for timesharing systems. *Microcomputers*, which for the first time relied on a single integrated chip as the CPU, truly fit on an individual’s desk. Their introduction gave rise to the idea of a *personal computer* (PC). As the term implies, a personal computer is not designed for multiperson use, and originally personal computer operating systems reflected this simplicity. Over time, personal computers evolved in functionality and incorporated many aspects of larger systems, such as timesharing. Although a desktop machine is still often referred to as a *PC*, the term *workstation* is sometimes used and is perhaps more appropriate, describing the machine as generally dedicated to an individual but

**Mainframe** A large, multiuser computer often associated with early timesharing systems

**Dumb terminal** A monitor and keyboard that allowed the user to access the mainframe computer in early timesharing systems

### Influential computing jobs

There were many influential jobs in computing in the 1960s, but none more so than the computer operator. In his or her hands rested the decision of whose computer jobs ran and when. Many a graduate student was known to have bribed a weary operator with coffee and cookies in the wee hours of the morning for just one more run.

capable of supporting much more. Operating systems, in turn, evolved to support these changes in the use of computers.

Operating systems must also take into account the fact that computers are usually connected to networks. Today with the Web, we take network communication for granted. Networks are discussed in detail in a later chapter, but we must acknowledge here the affect that network communication has on operating systems. Such communication is yet another resource that an OS must support.

An operating system is responsible for communicating with a variety of devices. Usually that communication is accomplished with the help of a device driver, a small program that “knows” the way a particular device expects to receive and deliver information. With device drivers, every operating system no longer needs to know about every device with which it might possibly be expected to communicate in the future. It’s another beautiful example of abstraction. An appropriate device driver often comes with new hardware, and the most up-to-date drivers can often be downloaded for free from the manufacturing company’s website.

One final aspect of operating systems is the need to support real-time systems. A **real-time system** is one that must provide a guaranteed minimum **response time** to the user. That is, the delay between receiving a stimulus and producing a response must be carefully controlled. Real-time responses are crucial in software that, for example, controls a robot, a nuclear reactor, or a missile. Although all operating systems acknowledge the importance of response time, a real-time operating system strives to optimize it.

#### Real-time system

A system in which response time is crucial given the nature of the application domain

**Response time** The time delay between receiving a stimulus and producing a response

## 10.2 Memory Management

Let’s review what we said about main memory in Chapter 5. All programs are stored in main memory when they are executed. All data referenced by those programs are also stored in main memory so that they can be accessed. Main memory can be thought of as a big, continuous chunk of space divided into groups of 8, 16, or 32 bits. Each byte or word of memory has a corresponding address, which is simply an integer that uniquely identifies that particular part of memory. See **FIGURE 10.4**. The first memory address is 0.

Earlier in this chapter we stated that in a multiprogramming environment, multiple programs (and their data) are stored in main memory at the same time. Thus operating systems must employ techniques to perform the following tasks:

- Track where and how a program resides in memory
- Convert logical program addresses into actual memory addresses

A program is filled with references to variables and to other parts of the program code. When the program is compiled, these references are changed into the addresses in memory where the data and code reside. But given that we don't know exactly where a program will be loaded into main memory, how can we know which address to use for anything?

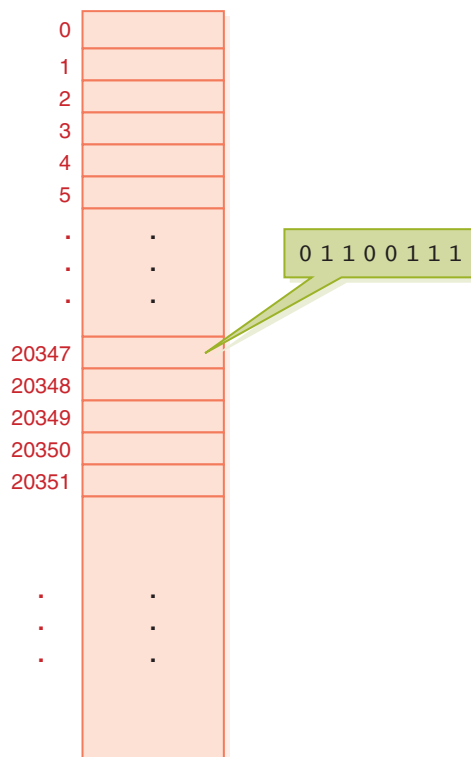
The solution is to use two kinds of addresses: logical addresses and physical addresses. A **logical address** (sometimes called a *virtual* or *relative* address) is a value that specifies a generic location relative to the program but not to the reality of main memory. A **physical address** is an actual address in the main memory device, as shown in Figure 10.4.

When a program is compiled, a reference to an identifier (such as a variable name) is changed to a logical address. When the program is eventually loaded into memory, each logical address is translated into a specific physical address. The mapping of a logical address to a physical address is called **address binding**. The later we wait to bind a logical address to a physical one, the more flexibility we have. Logical addresses

**Logical address** A reference to a stored value relative to the program making the reference

**Physical address** An actual address in the main memory device

**Address binding** The mapping from a logical address to a physical address



**FIGURE 10.4** Memory is a continuous set of bits referenced by specific addresses

allow a program to be moved around in memory or loaded in different places at different times. As long as we keep track of where the program is stored, we can always determine the physical address that corresponds to any given logical address. To simplify our examples in this chapter, we perform address-binding calculations in base 10.

The following sections examine the underlying principles of three techniques:

- Single contiguous memory management
- Partition memory management
- Paged memory management

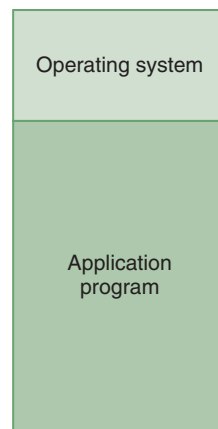
## Single Contiguous Memory Management

Let's initially keep things simple by assuming that there are only two programs in memory: the operating system and the application program we want to execute. We divide main memory up into two sections, one for each program, as shown in [FIGURE 10.5](#). The operating system gets what space it needs, and the program is allocated the rest.

This approach is called **single contiguous memory management** because the entire application program is loaded into one large chunk of memory. Only one program other than the operating system can be processed at one time. To bind addresses, all we have to take into account is the location of the operating system.

In this memory management scheme, a logical address is simply an integer value relative to the starting point of the program. That is, logical

**Single contiguous memory management** The approach to memory management in which a program is loaded into one continuous area of memory



**FIGURE 10.5** Main memory divided into two sections

addresses are created as if the program loaded at location 0 of main memory. Therefore, to produce a physical address, we add a logical address to the starting address of the program in physical main memory.

Let's get a little more specific: If the program is loaded starting at address  $A$ , then the physical address corresponding to logical address  $L$  is  $A + L$ . See [FIGURE 10.6](#). Let's plug in real numbers to make this example clearer. Suppose the program is loaded into memory beginning at address 555555. When a program uses relative address 222222, we know that it is actually referring to address 777777 in physical main memory.

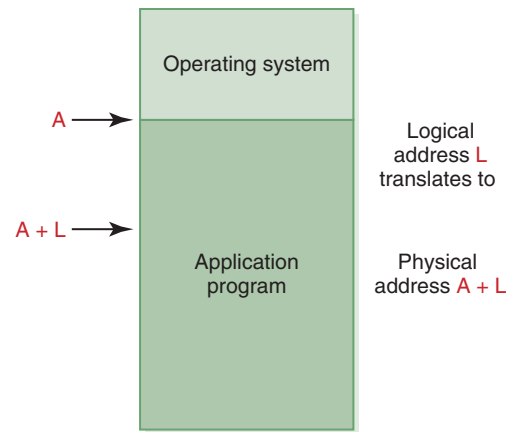
It doesn't really matter what address  $L$  is. As long as we keep track of  $A$  (the starting address of the program), we can always translate a logical address into a physical one.

You may be saying at this point, "If we switched the locations of the operating system and the program, then the logical and physical addresses for the program would be the same." That's true. But then you'd have other things to worry about. For example, a memory management scheme must always take security into account. In particular, in a multiprogramming environment, we must prevent a program from accessing any addresses beyond its allocated memory space. With the operating system loaded at location 0, all logical addresses for the program are valid unless they exceed the bounds of main memory itself. If we move the operating system below the program, we must make sure a logical address doesn't try to access the memory space devoted to the operating system. This wouldn't be difficult, but it would add to the complexity of the processing.

The advantage of the single contiguous memory management approach is that it is simple to implement and manage. However, it almost certainly wastes both memory space and CPU time. An application program is unlikely to need all of the memory not used by the operating system, and CPU time is wasted when the program has to wait for some resource.

## Partition Memory Management

Once multiple programs are allowed in memory, it's the operating system's job to ensure that one program doesn't access another's memory space. This is an example of a security mechanism implemented at a low level, generally outside the knowledge of the user. Higher-level issues are discussed in Chapter 17.



**FIGURE 10.6** Binding a logical address to a physical address

### Phone disconnect

?

Have you noticed that your computer wants you to explicitly eject your flash drive, but doesn't seem to care if you just unplug your phone? That's because your phone has its own power source. A phone can finish or abort any write operations on battery power, if need be, whereas if you disconnect a USB drive without warning, information can be lost.



**Fixed-partition technique**

The memory management technique in which memory is divided into a specific number of partitions into which programs are loaded

**Dynamic-partition technique**

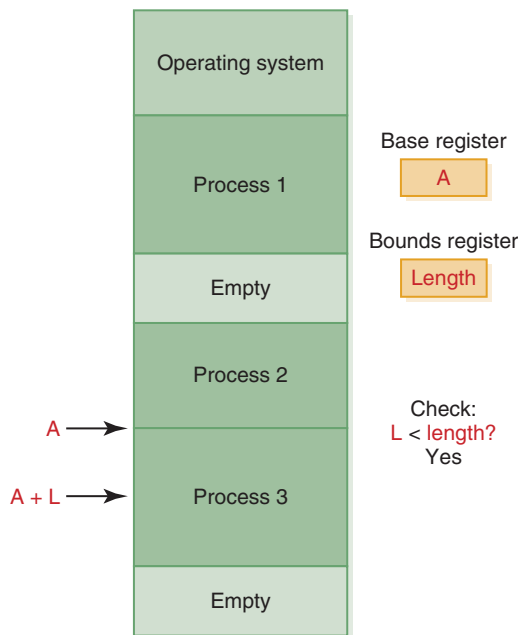
The memory management technique in which memory is divided into partitions as needed to accommodate programs

A more sophisticated approach is to have more than one application program in memory at the same time, sharing memory space and CPU time. In this case, memory must be divided into more than two partitions. Two strategies can be used to partition memory: fixed partitions and dynamic partitions. With the **fixed-partition technique**, main memory is divided into a particular number of partitions. The partitions do not have to be the same size, but their size is fixed when the operating system initially boots. A job is loaded into a partition large enough to hold it. The OS keeps a table of addresses at which each partition begins and the length of the partition.

With the **dynamic-partition technique**, the partitions are created to fit the unique needs of the programs. Main memory is initially viewed as one large empty partition. As programs are loaded, space is “carved out,” using only the space needed to accommodate the program and leaving a new, smaller, empty partition, which may be used by another program later. The operating system maintains a table of partition information, but in dynamic partitions the address information changes as programs come and go.

At any point in time in both fixed and dynamic partitions, memory is divided into a set of partitions, some empty and some allocated to programs. See [FIGURE 10.7](#).

Address binding is basically the same for both fixed and dynamic partitions. As with the single contiguous memory management approach,



**FIGURE 10.7** Address resolution in partition memory management

a logical address is an integer relative to a starting point of 0. There are various ways an OS might handle the details of the address translation. One way is to use two special-purpose registers in the CPU to help manage addressing. When a program becomes active on the CPU, the OS stores the address of the beginning of that program's partition into the **base register**. Similarly, the length of the partition is stored in the **bounds register**. When a logical address is referenced, it is first compared to the value in the bounds register to make sure the reference is within that program's allocated memory space. If it is, the value of the logical address is added to the value in the base register to produce the physical address.

Which partition should we allocate to a new program? There are three general approaches to partition selection:

- *First fit*, in which the program is allocated to the first partition big enough to hold it
- *Best fit*, in which the program is allocated to the smallest partition big enough to hold it
- *Worst fit*, in which the program is allocated to the largest partition big enough to hold it

It doesn't make sense to use worst fit in fixed partitions because it would waste the larger partitions. First fit and best fit both work for fixed partitions. In dynamic partitions, however, worst fit often works best because it leaves the largest possible empty partition, which may accommodate another program later on.

When a program terminates, the partition table is updated to reflect the fact that the partition is now empty and available for a new program. In dynamic partitions, consecutive empty partitions are merged into one big empty partition.

Partition memory management makes efficient use of main memory by maintaining several programs in memory at one time. But keep in mind that a program must fit entirely into one partition. Fixed partitions are easier to manage than dynamic ones, but they restrict the opportunities available to incoming programs. The system may have enough free memory to accommodate the program, just not in one free partition. In dynamic partitions, the jobs could be shuffled around in memory to create one large free partition. This procedure is known as *compaction*.

## Paged Memory Management

Paged memory management places more of the burden on the operating system to keep track of allocated memory and to resolve addresses. However, the benefits gained by this approach are generally worth the extra effort.

**Base register** A register that holds the beginning address of the current partition

**Bounds register** A register that holds the length of the current partition

### What is Bitcoin?

Bitcoin, a peer-to-peer payment system introduced in 2009, is loosely referred to as a *digital currency* or a *cryptocurrency*. A currency is used as a medium of exchange or as a store of value. Bitcoin is a currency as long as businesses choose to accept Bitcoins in payment. Their use and value have fluctuated widely since their introduction. In mid-2017 the value of a bitcoin skyrocketed to over \$19,000. A few months later it had dropped back to \$7,000.<sup>1,4</sup>

**Paged memory technique**

A memory management technique in which processes are divided into fixed-size pages and stored in memory frames when loaded

**Frame** A fixed-size portion of main memory that holds a process page

**Page** A fixed-size portion of a process that is stored into a memory frame

**Page-map table (PMT)** The table used by the operating system to keep track of page/frame relationships

In the **paged memory technique**, main memory is divided into small fixed-size blocks of storage called **frames**. A process is divided into **pages** that (for the sake of our discussion) we assume are the same size as a frame. When a program is to be executed, the pages of the process are loaded into unused frames distributed through memory. Thus the pages of a process may be scattered around, out of order, and mixed among the pages of other processes. To keep track of these pages, the operating system maintains a separate **page-map table (PMT)** for each process in memory; it maps each page to the frame in which it is loaded. See **FIGURE 10.8**. Both pages and frames are numbered starting with zero, which makes the address calculations easier.

| P1 PMT |       | Memory |          |
|--------|-------|--------|----------|
| Page   | Frame | Frame  | Contents |
| 0      | 5     | 0      |          |
| 1      | 12    | 1      | P2/Page2 |
| 2      | 15    | 2      |          |
| 3      | 7     | 3      |          |
| 4      | 22    | 4      |          |
|        |       | 5      | P1/Page0 |
|        |       | 6      |          |
|        |       | 7      | P1/Page3 |
|        |       | 8      |          |
|        |       | 9      |          |
|        |       | 10     | P2/Page0 |
|        |       | 11     | P2/Page3 |
|        |       | 12     | P1/Page1 |
|        |       | 13     |          |
|        |       | 14     |          |
|        |       | 15     | P1/Page2 |
|        |       |        | .        |
|        |       |        | .        |
|        |       |        | .        |

**FIGURE 10.8** A paged memory management approach

A logical address in a paged memory management system begins as a single integer value relative to the starting point of the program, as it was in a partitioned system. This address is modified into two values, a page number and an offset, by dividing the address by the page size. The page number is the number of times the page size divides the address, and the remainder is the offset. So a logical address of **2566**, with a page size of 1024, corresponds to the 518th byte of page 2 of the process. A logical address is often written as **<page, offset>**, such as **<2, 518>**.

To produce a physical address, you first look up the page in the PMT to find the frame number in which it is stored. You then multiply the frame number by the frame size and add the offset to get the physical address. For example, given the situation shown in **FIGURE 10.8**, if process 1 is active, a logical address of **<1, 222>** would be processed as follows: Page 1 of process 1 is in frame 12; therefore, the corresponding physical address is  $12 * 1024 + 222$ , or **12510**. Note that there are two ways in which a logical address could be invalid: The page number could be out of bounds for that process, or the offset could be larger than the size of a frame.

The advantage of paging is that a process no longer needs to be stored contiguously in memory. The ability to divide a process into pieces changes the challenge of loading a process from finding one large chunk of space to finding many small chunks.

An important extension to the idea of paged memory management is the idea of **demand paging**, which takes advantage of the fact that not all parts of a program actually have to be in memory at the same time. At any given point in time, the CPU is accessing one page of a process. At that point, it doesn't really matter whether the other pages of that process are even in memory.

In demand paging, the pages are brought into memory on demand. That is, when a page is referenced, we first see whether it is in memory already and, if it is, complete the access. If it is not already in memory, the page is brought in from secondary memory into an available frame, and then the access is completed. The act of bringing in a page from secondary memory, which often causes another page to be written back to secondary memory, is called a **page swap**.

The demand paging approach gives rise to the idea of **virtual memory**, the illusion that there are no restrictions on the size of a program (because the entire program is not necessarily in memory at the same time). In all of the memory management techniques we examined earlier, the entire process had to be brought into memory as a continuous whole. We therefore always had an upper bound on process size. Demand paging removes that restriction.

#### Demand paging

An extension to paged memory management in which pages are brought into memory only when referenced (on demand)

**Page swap** Bringing in one page from secondary memory, possibly causing another to be removed

**Virtual memory** The illusion that there is no restriction on program size because an entire process need not be in memory at the same time

However, virtual memory comes with lots of overhead during the execution of a program. With other memory management techniques, once a program was loaded into memory, it was all there and ready to go. With the virtual memory approach, we constantly have to swap pages between main and secondary memory. This overhead is usually acceptable—while one program is waiting for a page to be swapped, another process can take control of the CPU and make progress. Excessive page swapping is called **thrashing** and can seriously degrade system performance.

**Thrashing** Inefficient processing caused by constant page swapping

**Process states** The conceptual stages through which a process moves as it is managed by the operating system

## 10.3 Process Management

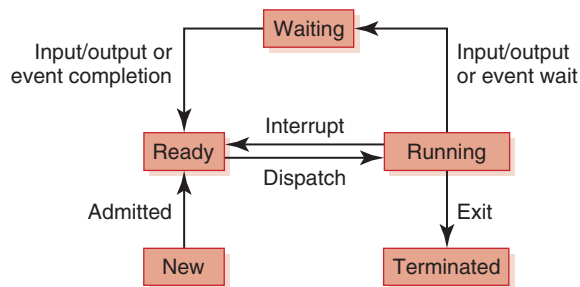
Another important resource that an operating system must manage is the use of the CPU by individual processes. To understand how an operating system manages processes, we must recognize the stages that a process goes through during its computational life and understand the information that must be managed to keep a process working correctly in a computer system.

### The Process States

Processes move through specific states as they are managed in a computer system. That is, a process enters the system, is ready to be executed, is executing, is waiting for a resource, or is finished. **FIGURE 10.9** depicts these **process states**. In the figure, each box represents a state a process might be in, and the arrows indicate how and why a process might move from one state to another.

Let's examine what is happening to a process in each state.

- In the *new state*, a process is being created. It may, for instance, be a login process created by a user logging onto a timesharing system, an application process created when a user submits a program for execution, or a system process created by the operating system to accomplish a specific system task.



**FIGURE 10.9** The process life cycle

- A process that has no barriers to its execution is in the *ready state*. A process in the ready state is not waiting for an event to occur or for data to be brought in from secondary memory. Instead, it is waiting for its chance to use the CPU.
- A process in the *running state* is currently being executed by the CPU. Its instructions are being processed in the fetch–execute cycle.
- A process in the *waiting state* is currently waiting for resources (other than the CPU). For example, a process in the waiting state may be waiting for a page of its memory to be brought in from secondary memory or for another process to send it a signal that it may continue.
- A process in the *terminated state* has completed its execution and is no longer active. At this point the operating system no longer needs to maintain the information regarding the process.

Note that many processes may be in the ready state or the waiting state at the same time, but only one process can be in the running state.

After a process is created, the operating system admits it to the ready state. When the CPU-scheduling algorithm dictates, a process is dispatched to the running state. (CPU scheduling is discussed in more detail in Section 10.4.)

While running, the process might be interrupted by the operating system to allow another process to have its chance on the CPU. In that case, the process simply returns to the ready state. Alternatively, a running process might request a resource that is not available or require I/O to retrieve a newly referenced part of the process, in which case it is moved to the waiting state. A running process may finally get enough CPU time to complete its processing and terminate normally; otherwise, it may generate an unrecoverable error and terminate abnormally.

When a waiting process gets the resource it is waiting for, it moves to the ready state again.

## The Process Control Block

The operating system must manage a large amount of data for each active process. Usually this data is stored in a data structure called a **process control block (PCB)**. Generally, each state is represented by a list of PCBs, one for each process in that state. When a process moves from one state to another, its corresponding PCB moves from one state list to another in the operating system. A new PCB is created when a process is first created (the new state) and persists until the process terminates.

**Process control block (PCB)** The data structure used by the operating system to manage information about a process

The PCB stores a variety of information about the process, including the current value of the program counter, which indicates the instruction in the process that is to be executed next. As the life cycle in Figure 10.8 indicates, a process may be interrupted many times during its execution. At each point, its program counter must be stored so that the next time the process gets into the running state it can pick up where it left off.

The PCB also stores the values of all other CPU registers for that process. Keep in mind that there is only one CPU and therefore only one set of CPU registers. These registers contain the values for the currently executing process (the one in the running state). Each time a process moves to the running state, the register values for the currently running process are stored into its PCB, and the register values of the new running state are loaded into the CPU. This exchange of information is called a **context switch**.

The PCB also maintains information about CPU scheduling, such as the priority that a process is given by the operating system. It contains memory management information as well, such as base and bound register values (for partitions) or page tables (for paged systems). Finally, the PCB holds accounting information, such as account numbers, time limits, and the amount of CPU time used so far.

**Context switch** The exchange of register information that occurs when one process is removed from the CPU and another takes its place

**Nonpreemptive scheduling** CPU scheduling that occurs when the currently executing process gives up the CPU voluntarily

**Preemptive scheduling** CPU scheduling that occurs when the operating system decides to favor another process, preempting the currently executing process

**Turnaround time** The CPU-scheduling metric that measures the elapsed time between a process's arrival in the ready state and its ultimate completion

## 10.4 CPU Scheduling

CPU scheduling is the act of determining which process in the ready state should be moved to the running state. That is, CPU-scheduling algorithms decide which process should be given over to the CPU so that it can make computational progress.

CPU-scheduling decisions are made when a process switches from the running state to the waiting state, or when a program terminates. This type of CPU scheduling is called **nonpreemptive scheduling**, because the need for a new CPU process results from the activity of the currently executing process.

CPU-scheduling decisions may also be made when a process moves from the running state to the ready state or when a process moves from the waiting state to the ready state. These are examples of **preemptive scheduling**, because the currently running process (through no fault of its own) is preempted by the operating system.

Scheduling algorithms are often evaluated using metrics, such as the **turnaround time** for a process. This measure is the amount of time between when a process arrives in the ready state and when it exits the running state for the last time. We would like, on average, for the turnaround time for our processes to be small.

Several different approaches can be used to determine which process gets chosen first to move from the ready state to the running state. We examine three of them in the next sections.

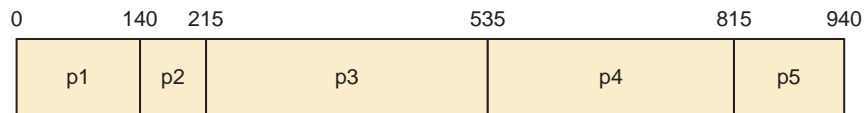
## First Come, First Served

In the first-come, first-served (FCFS) scheduling approach, processes are moved to the CPU in the order in which they arrive in the running state. FCFS scheduling is nonpreemptive. Once a process is given access to the CPU, it keeps that access unless it makes a request that forces it to wait, such as a request for a device in use by another process.

Suppose processes p1 through p5 arrive in the ready state at essentially the same time (to make our calculations simple) but in the following order and with the specified service time:

| Process | Service Time |
|---------|--------------|
| p1      | 140          |
| p2      | 75           |
| p3      | 320          |
| p4      | 280          |
| p5      | 125          |

In the FCFS scheduling approach, each process receives access to the CPU in turn. For simplicity, we assume here that processes don't cause themselves to wait. The following Gantt chart shows the order and time of process completion:



Because we are assuming the processes all arrived at the same time, the turnaround time for each process is the same as its completion time. The average turnaround time is  $(140 + 215 + 535 + 815 + 940) / 5$  or 529.

In reality, processes do not arrive at exactly the same time. In this case, the calculation of the average turnaround time would be similar, but would take into account the arrival time of each process. The turnaround time for each process would be its completion time minus its arrival time.

The FCFS algorithm is easy to implement but suffers from its lack of attention to important factors such as service time requirements. Although we used the service times in our calculations of turnaround

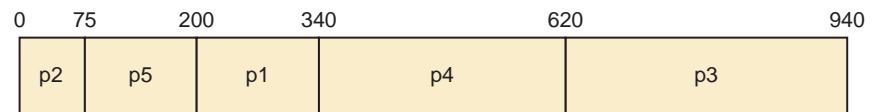


time, the algorithm didn't use that information to determine the best order in which to schedule the processes.

## Shortest Job Next

The shortest-job-next (SJN) CPU-scheduling algorithm looks at all processes in the ready state and dispatches the one with the smallest service time. Like FCFS, it is generally implemented as a nonpreemptive algorithm.

Below is the Gantt chart for the same set of processes we examined in the FCFS example. Because the selection criteria are different, the order in which the processes are scheduled and completed are different:



The average turnaround time for this example is  $(75 + 200 + 340 + 620 + 940) / 5$  or 435.

Note that the SJN algorithm relies on knowledge of the future. That is, it gives access to the CPU to the job that runs for the shortest time when it is allowed to execute. That time is essentially impossible to determine. Thus, to run this algorithm, the service time value for a process is typically estimated by the operating system using various probability factors and taking the type of job into account. If these estimates are wrong, the premise of the algorithm breaks down and its efficiency deteriorates. The SJN algorithm is provably optimal, meaning that if we could know the service time of each job, the algorithm would produce the shortest turnaround time for all jobs compared to any other algorithm. However, because we can't know the future absolutely, we make guesses and hope those guesses are correct.

## Round Robin

Round-robin CPU scheduling distributes the processing time equitably among all ready processes. This algorithm establishes a particular **time slice** (or time quantum), which is the amount of time each process receives before it is preempted and returned to the ready state to allow another process to take its turn. Eventually the preempted process will be given another time slice on the CPU. This procedure continues until the process gets all the time it needs to complete and terminates.

?

### Tracking your workout

In 2006, Nike and Apple created a product that enables a sneaker to talk to an iPod wirelessly. The Nike sensor is inserted into selected sneakers, together with a wireless rig. The system lets a runner record the distance, time, pace, and calories burned during each workout and downloads its data digitally using Apple's iTunes music software. Today, devices such as FitBit, specifically designed for health tracking, are commonplace.

**Time slice** The amount of time given to each process in the round-robin CPU-scheduling algorithm

© Artur Debat/Getty Images; © Alan Dyer/Stocktrek Images/Getty Images

## Steve Jobs

Born in 1955, Steve Jobs is probably best known for founding Apple Computer together with Steve Wozniak and Ronald Wayne in 1976. At the time, most computers were either mainframes (sometimes as large as a small room) or minicomputers (about the size of a refrigerator), often anything but user-friendly, and almost exclusively used by big businesses. Jobs had a vision of a personal computer that would be accessible to everyone. He is often credited with democratizing the computer.

Jobs and Wozniak designed the Apple I in Jobs's bedroom and built it in the garage of his parents' house. Jobs and Wozniak sold their prize possessions (a Volkswagen microbus and a Hewlett-Packard scientific calculator, respectively) to raise the \$1300 capital with which they founded their company. Four years later, Apple went public. At the end of the first day of trading, the company had a market value of \$1.2 billion.

Jobs headed the team that developed the Apple Macintosh (named after the McIntosh apple), perhaps the most famous of the Apple computers. The Macintosh was the first commercially successful computer to be launched with a graphical user interface and a mouse. Shortly after the launch of the Macintosh, Jobs was forced out of Apple after a power struggle with John Sculley, Apple's CEO at the time.

Having been ousted from the company he founded, Jobs began another computer company, NeXT, which was purchased by Apple in 1996 for \$402 million. Not only did the acquisition bring Jobs back to his original company, but it also made him CEO of Apple. Under his renewed leadership, Apple launched the iMac, which has been described as the "gold standard of desktop computing."

In 1986, Jobs moved into the field of computer-generated animation when he bought a computer graphics company and renamed it *Pixar*. Pixar has produced a number of box office hits, including *A Bug's Life*, *Toy Story*, *Monsters, Inc.*, and *Finding Nemo*.

Jobs, himself a university dropout, gave the 2005 commencement address at Stanford University, in which he imparted the following piece of career advice to the graduates: "You've got to find what you love."

In 2007 Jobs was named the most powerful person in business by *Fortune* magazine, and Governor Arnold Schwarzenegger inducted Jobs into the California Hall of Fame. In August 2011 Jobs resigned as CEO of Apple; he was elected Chairman of the Board. Tim Cook took over as CEO of Apple. After battling pancreatic cancer, Steve Jobs died on October 5, 2011, at the age of 56.

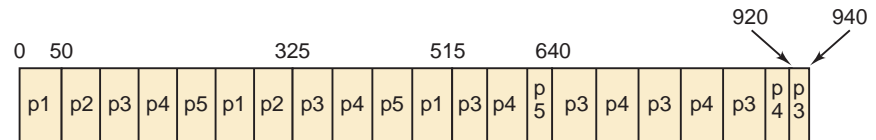


© Christophe Ena/AP Photos

Note that the round-robin algorithm is preemptive. The expiration of a time slice is an arbitrary reason to remove a process from the CPU. This action is represented by the transition from the running state to the ready state.

## Chapter 10: Operating Systems

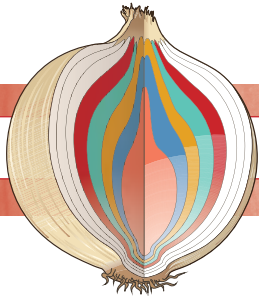
Suppose the time slice used for a particular round-robin scheduling algorithm was 50 and we used the same set of processes as our previous examples. The Gantt chart results are:



Each process is given a time slice of 50, unless it doesn't need a full slice. For example, process 2 originally needed 75 time units. It was given an initial time slice of 50. When its turn to use the CPU came around again, it needed only 25 time units. Therefore, process 2 terminates and gives up the CPU at time 325.

The average turnaround time for this example is  $(515 + 325 + 940 + 920 + 640) / 5$ , or 668. This turnaround time is larger than the times in the other examples. Does that mean the round-robin algorithm is not as good as the other options? No. We can't make such general claims based on one example. We can say only that one algorithm is better than another for that specific set of processes. General analysis of algorithm efficiencies is much more involved.

The round-robin CPU process scheduling algorithm is probably the most widely used. It generally supports all kinds of jobs and is considered the most fair.



## SUMMARY

An operating system is the part of the system software that manages resources on a computer. It serves as moderator among human users, application software, and the hardware devices in the system.

Multiprogramming is the technique for keeping multiple programs in memory at the same time, contending for time on the CPU. A process is a program in execution. The operating system must perform careful CPU scheduling, memory management, and process management to ensure fair access to the CPU.

Batch processing organizes jobs into batches that use the same or similar resources. Timesharing allows multiple users to interact with a computer at the same time, creating a virtual machine for each user.

An operating system must manage memory to control and monitor where processes are loaded into main memory. Any memory management technique must define the manner in which it binds a logical address to a physical one. Various strategies have been developed for memory management. The single contiguous approach allows only one program other than the operating system to be in main memory. The partition approach divides memory into several partitions into which processes are loaded. Fixed partitions have a set size, whereas dynamic partitions are created to satisfy the unique needs of the processes loaded. Paging divides memory into frames and programs into pages. The pages of a program need not be contiguous in memory. Demand paging allows for only a portion of a program to be in memory at any given time.

An operating system manages a process's life states, which are the stages a program goes through during its execution. The process control block stores the necessary information for any process.

CPU-scheduling algorithms determine which process gets priority to use the CPU next. First-come, first-served CPU scheduling gives priority to the earliest-arriving job. The shortest-job-next algorithm gives priority to jobs with short running times. Round-robin scheduling rotates the CPU among active processes, giving a little time to each process.



## ETHICAL ISSUES

### Medical Privacy: HIPAA<sup>2,3</sup>

Beginning in 2003, when you went to the doctor, you had to sign several new forms. The nurse would simply say “HIPAA,” and shrug his or her shoulders. To many, HIPAA simply meant more papers to sign.

The Health Insurance Portability and Accountability Act (HIPAA) of 1996 took effect in 2003. Title I of HIPAA protects health coverage for those that change or lose their job. Title II of HIPAA, known as the *Administrative Simplification provision*, required the establishment of national standards for electronic health care transactions and provided security and privacy of health data. Thus many doctors’ visits and procedures require the patient to sign that they understand their rights under HIPAA.

HIPAA sets a national standard for accessing and handling medical information. Patients are now guaranteed the right to see their own medical records. Patients must be given notices of privacy practices; thus, the influx of new paperwork. Patients have the right to find out who has accessed their health records for the prior six years. Patients may request that confidential communications be sent to their homes rather than their offices. Patients do not have to have their names included in a hospital directory, and they can choose with whom their medical information may be discussed.

The HIPAA Privacy Rule establishes a set of national standards for the protection

of certain health information. This rule applies to health plans, health care clearinghouses, and any health care provider using electronic means to transmit health care information. The rule protects all “individually identifiable health information.” This information includes demographic data that relates to an individual’s past, present, or future mental or physical health condition, the provision of health care to the individual, and past, present, or future payment for the provision of health care that can identify the individual. Once all the identifying information has been removed, there is no restriction on the use of this de-identified health information.

Current technology that allows collecting and sharing of de-identified information can help doctors diagnose patients, researchers develop new drugs, and governments track and combat public health threats like the 2003 outbreak of severe acute respiratory syndrome (SARS).

However, privacy rights advocates claim that there are weaknesses in the system. For example, HIPAA applies only to electronic medical records used by healthcare professionals. Much health-related information exists outside of health care facilities.

For example, life insurance companies, workers’ compensation, agencies that deliver Social Security and welfare benefits, automobile insurance plans that include health



## ETHICAL ISSUES

### Medical Privacy: HIPAA (CONTINUED)

benefits, Internet self-help sites, and those who conduct public screenings for blood pressure and/or cholesterol are not covered under HIPAA.

As part of the 2009 Stimulus Law, \$19 billion was allotted toward making electronic

health records for all Americans by 2014. The law also calls for changes to the HIPAA Privacy Rule to offer better privacy protection and authorizes broader enforcement against HIPAA violations.

© Artur Debat/Getty Images; © Alan Dyer/Stocktrek Images/Getty Images

## KEY TERMS

Address binding  
 Application software  
 Base register  
 Bounds register  
 Context switch  
 CPU scheduling  
 Demand paging  
 Dumb terminal  
 Dynamic-partition technique  
 Fixed-partition technique  
 Frame  
 Logical address  
 Mainframe  
 Memory management  
 Multiprogramming  
 Nonpreemptive scheduling  
 Operating system  
 Page  
 Page-map table (PMT)

Page swap  
 Paged memory technique  
 Physical address  
 Preemptive scheduling  
 Process  
 Process control block (PCB)  
 Process management  
 Process states  
 Real-time system  
 Response time  
 Single contiguous memory management  
 System software  
 Thrashing  
 Time slice  
 Timesharing  
 Turnaround time  
 Virtual machine  
 Virtual memory

**EXERCISES**

For Exercises 1–18, mark the answers true or false as follows:

- A. True
  - B. False
1. An operating system is an example of application software.
  2. An operating system provides a basic user interface that allows the user to use the computer.
  3. A computer can have more than one operating system, but only one OS is in control at any given time.
  4. Multiprogramming is the technique of using multiple CPUs to run programs.
  5. In the 1960s and 1970s, a human operator would organize similar computer jobs into batches to be run.
  6. Batch processing implies a high level of interaction between the user and the program.
  7. A timesharing system allows multiple users to interact with a computer at the same time.
  8. A dumb terminal is an I/O device that connects to a mainframe computer.
  9. A logical address specifies an actual location in main memory.
  10. An address in a single contiguous memory management system is made up of a page and an offset.
  11. In a fixed-partition system, main memory is divided into several partitions of the same size.
  12. The bounds register contains the last address of a partition.

13. The first page in a paged memory system is page 0.
14. A process in the running state is currently being executed by the CPU.
15. The process control block (PCB) is a data structure that stores all information about a process.
16. CPU scheduling determines which programs are in memory.
17. The first-come, first-served scheduling algorithm is probably optimal.
18. A time slice is the amount of time each process is given before being preempted in a round-robin scheduler.

For Exercises 19–23, match the operating system with information about it.

- A. Mac OS
  - B. UNIX
  - C. Linux
  - D. DOS
  - E. Windows
19. Which is the operating system of choice for Apple computers?
  20. Historically, which is the operating system of choice for serious programmers?
  21. Which is the PC version of UNIX?
  22. What is the Microsoft operating system family provided on PCs called?
  23. What is the original PC operating system called?

**EXERCISES (CONTINUED)**

For Exercises 24–26, match the following software type with its definition.

- A. Systems software
- B. Operating system
- C. Application software

- 24. Programs that help us solve real-world problems
- 25. Programs that manage a computer system and interact with hardware
- 26. Programs that manage computer resources and provide interfaces for other programs

Exercises 27–72 are problems or short-answer questions.

- 27. Distinguish between application software and system software.
- 28. What is an operating system?
- 29. Explain the term *multiprogramming*.
- 30. The following terms relate to how the operating system manages multiprogramming. Describe the part each plays in this process.
  - a. Process
  - b. Process management
  - c. Memory management
  - d. CPU scheduling
- 31. What constitutes a batch job?
- 32. Describe the evolution of the concept of batch processing from the human operator in the 1960s and 1970s to the operating systems of today.
- 33. Define *timesharing*.
- 34. What is the relationship between multiprogramming and timesharing?
- 35. Why do we say that users in a timesharing system have their own virtual machine?
- 36. In Chapter 6, we defined a virtual machine as a hypothetical machine designed to illustrate important features of a real machine. In this chapter, we define a virtual machine as the illusion created by a timesharing system that each user has a dedicated machine. Relate these two definitions.
- 37. How does the timesharing concept work?
- 38. What is a real-time system?
- 39. What is response time?
- 40. What is the relationship between real-time systems and response time?
- 41. In a multiprogramming environment, many processes may be active. What are the tasks that the operating system must accomplish to manage the memory requirements of active processes?
- 42. Distinguish between logical addresses and physical addresses.
- 43. What is address binding?
- 44. Name three memory management techniques and describe the general approach taken in each.
- 45. When is a logical address assigned to a variable?
- 46. When does address binding occur?
- 47. How is memory divided in the single contiguous memory management approach?
- 48. When a program is compiled, where is it assumed that the program will be loaded into memory? That is,



**EXERCISES (CONTINUED)**

- where are logical addresses assumed to begin?
49. If, in a single contiguous memory management system, the program is loaded at address **30215**, compute the physical addresses (in decimal) that correspond to the following logical addresses:
    - a. **9223**
    - b. **2302**
    - c. **7044**
  50. In a single contiguous memory management approach, if the logical address of a variable is  $L$  and the beginning of the application program is  $A$ , what is the formula for binding the logical address to the physical address?
  51. If, in a fixed-partition memory management system, the current value of the base register is **42993** and the current value of the bounds register is **2031**, compute the physical addresses that correspond to the following logical addresses:
    - a. **104**
    - b. **1755**
    - c. **3041**
  52. If more than one partition is being used (either fixed or dynamic), what does the base register contain?
  53. Why is the logical address compared to the bounds register before a physical address is calculated?
  54. If, in a dynamic-partition memory management system, the current value of the base register is **42993**

and the current value of the bounds register is **2031**, compute the physical addresses that correspond to the following logical addresses:

- a. **104**
- b. **1755**
- c. **3041**

Exercises 55 and 56 use the following state of memory.

|                     |
|---------------------|
| Operating system    |
| Process 1           |
| Empty<br>60 blocks  |
| Process 2           |
| Process 3           |
| Empty<br>52 blocks  |
| Empty<br>100 blocks |

**EXERCISES (CONTINUED)**

55. If the partitions are fixed and a new job arrives requiring 52 blocks of main memory, show memory after using each of the following partition selection approaches:
- First fit
  - Best fit
  - Worst fit
56. If the partitions are dynamic and a new job arrives requiring 52 blocks of main memory, show memory after using each of the following partition selection approaches:
- First fit
  - Best fit
  - Worst fit
57. If a logical address in a paged memory management system is  $\langle 2, 133 \rangle$ , what do the values mean?

Exercises 58–60 refer to the following PMT.

|       |   |   |   |   |
|-------|---|---|---|---|
| Page  | 0 | 1 | 2 | 3 |
| Frame | 5 | 2 | 7 | 3 |

58. If the frame size is 1024, what is the physical address associated with the logical address  $\langle 2, 85 \rangle$ ?
59. If the frame size is 1024, what is the physical address associated with the logical address  $\langle 3, 555 \rangle$ ?
60. If the frame size is 1024, what is the physical address associated with the logical address  $\langle 3, 1555 \rangle$ ?
61. What is virtual memory and how does it apply to demand paging?
62. What are the conceptual stages through which a process moves while being managed by the operating system?
63. Describe how a process might move through the various process states. Cite specific reasons why this process moves from one state to another.
64. What is a process control block?
65. How is each conceptual stage represented in the operating system?
66. What is a context switch?
67. Distinguish between preemptive scheduling and nonpreemptive scheduling.
68. Name and describe three CPU-scheduling algorithms.

Use the following table of processes and service time for Exercises 69 through 72.

|              |     |    |     |    |     |
|--------------|-----|----|-----|----|-----|
| Process      | P1  | P2 | P3  | P4 | P5  |
| Service time | 120 | 60 | 180 | 50 | 300 |

**EXERCISES (CONTINUED)**

69. Draw a Gantt chart that shows the completion times for each process using first-come, first-served CPU scheduling.
70. Draw a Gantt chart that shows the completion times for each process using shortest-job-next CPU scheduling.
71. Draw a Gantt chart that shows the completion times for each process using round-robin CPU scheduling with a time slice of 60.
72. Distinguish between fixed partitions and dynamic partitions.

## THOUGHT QUESTIONS

1. In Chapter 5, we said that the control unit was like the stage manager who organized and managed the other parts of the von Neumann machine. Suppose we now say the operating system is also like a stage manager, but on a much grander scale. Does this analogy hold or does it break down?
2. The user interface that the operating system presents to the user is like a hallway with doors leading to rooms housing applications programs. To go from one room to another, you have to go back to the hallway. Continue with this analogy: What would files be? What would be analogous to a time slice?
3. What is the difference between medical data and de-identified medical data?
4. Have you ever read the HIPAA papers you have signed?
5. Would you withhold sensitive personal and medical information from your doctor if you knew there was a possibility that it might not remain private?
6. Should medical identity cards contain genetic marker information if they ever become widely used in the United States?

## Laying the Groundwork

- 1 The Big Picture

## The Information Layer

- 2 Binary Values and Number Systems
- 3 Data Representation

## The Hardware Layer

- 4 Gates and Circuits
- 5 Computing Components

## The Programming Layer

- 6 Low-Level Programming Languages and Pseudocode
- 7 Problem Solving and Algorithms
- 8 Abstract Data Types and Subprograms
- 9 Object-Oriented Design and High-Level Programming Languages

## The Operating Systems Layer

- 10 Operating Systems
- 11 File Systems and Directories

## The Applications Layer

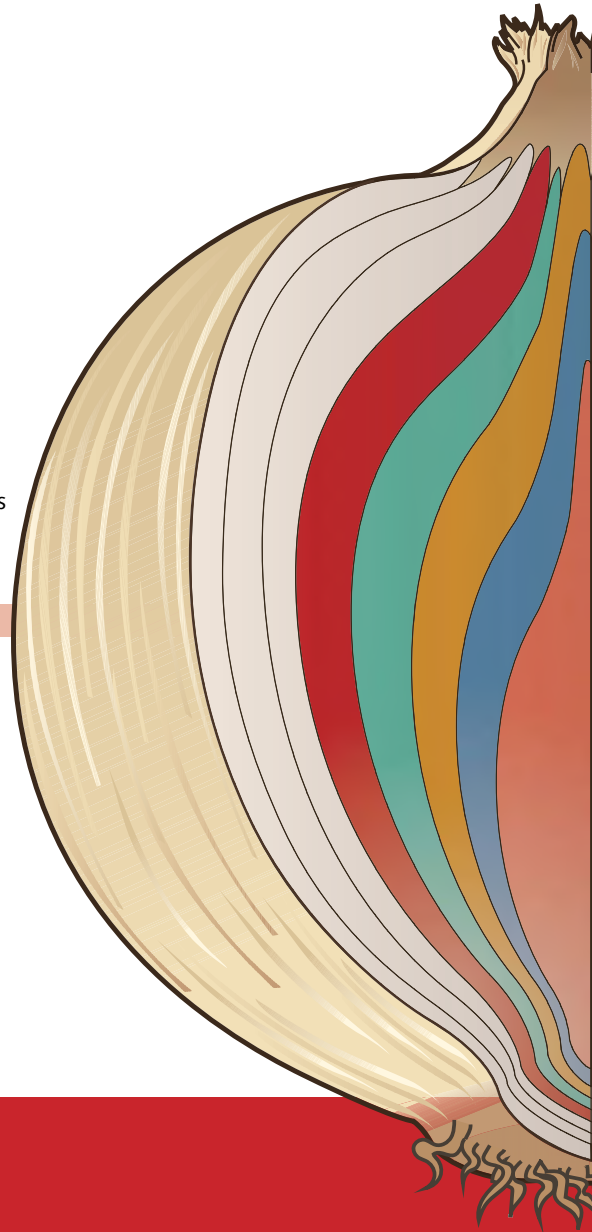
- 12 Information Systems
- 13 Artificial Intelligence
- 14 Simulation, Graphics, Gaming, and Other Applications

## The Communications Layer

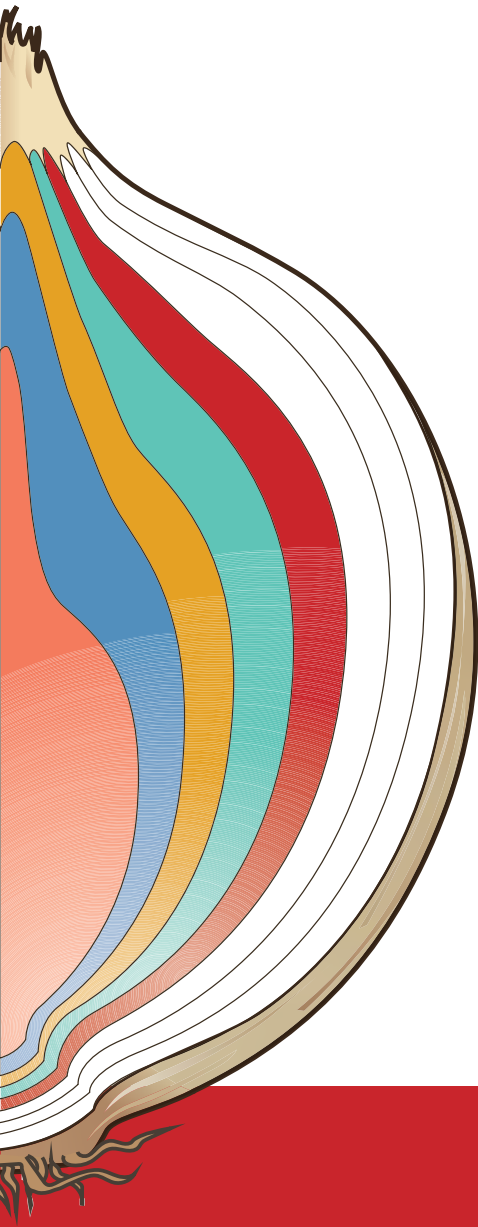
- 15 Networks
- 16 The World Wide Web
- 17 Computer Security

## In Conclusion

- 18 Limitations of Computing



# THE OPERATING SYSTEMS LAYER



## 11

# FILE SYSTEMS AND DIRECTORIES

The previous chapter examined some of the roles an operating system plays. In particular, it described the management of processes, the CPU, and main memory. Another key resource that the operating system manages is secondary memory—most importantly, magnetic disks. The organization of files and directories on disk plays a pivotal role in everyday computing. Like a card file on a desktop, the file system provides a way to access particular data in a well-organized manner. The directory structure organizes files into categories and subcategories. File systems and directory structures are explored in detail in this chapter.

## GOALS

After studying this chapter, you should be able to:

- describe the purpose of files, file systems, and directories.
- distinguish between text and binary files.
- identify various file types by their extensions.
- explain how file types improve file usage.
- define the basic operations on a file.
- compare and contrast sequential and direct file access.
- discuss the issues related to file protection.
- describe a directory tree.
- create absolute and relative paths for a directory tree.
- describe several disk-scheduling algorithms.

## 11.1 File Systems

In Chapter 5 we established the differences between main and secondary memory. Recall that main memory is where active programs and data are held while in use. Main memory is volatile, meaning that the data stored on it is lost if electric power is turned off. Secondary memory is nonvolatile—the data stored on it is maintained even when power is not on. Thus we use secondary memory for permanent storage of our data.

The most widely used secondary storage device is the magnetic disk drive. It includes both the hard drives that are found in the computer's main box and disks that are portable and can be moved easily between computers. The basic concepts underlying both types of disks are the same. Other secondary memory devices, such as tape drives, are used primarily for archival purposes. While many of the concepts that we explore in this chapter apply to all secondary storage devices, it's perhaps easiest to think about a standard disk drive.

We store data on a disk in files, a mechanism for organizing data on an electronic medium. A **file** is a named collection of related data. From the user's point of view, a file is the smallest amount of data that can be written to secondary memory. Organizing everything into files presents a uniform view for data storage. A **file system** is the logical view that an operating system provides so that users can manage data as a collection of files. A file system is often organized by grouping files into **directories**.

A file is a generic concept. Different types of files are managed in different ways. A file, in general, contains a program (in some form) or data (of one type or another). Some files have a very rigid format; others are more flexible.

A file may be considered a sequence of bits, bytes, lines, or records, depending on how you look at it. As with any data in memory, you have to apply an interpretation to the bits stored in a file before they have meaning. The creator of a file decides how the data in a file is organized, and any users of the file must understand that organization.

### Text and Binary Files

All files can be broadly classified as either text files or binary files. In a **text file**, the bytes of data are organized as characters from the ASCII or Unicode character sets. (Character sets are described in Chapter 3.) A **binary file** requires a specific interpretation of the bits based on the data in the file.

The terms “text file” and “binary file” are somewhat misleading. They seem to imply that the information in a text file is not stored as binary

**File** A named collection of data, used for organizing secondary memory

**File system** The operating system's logical view of the files it manages

**Directory** A named group of files

**Text file** A file that contains characters

**Binary file** A file that contains data in a specific format, requiring a special interpretation of its bits

data. Ultimately, however, all data on a computer is stored as binary digits. These terms refer to how those bits are formatted: as chunks of 8 or 16 bits, interpreted as characters, or in some other special format.

Some information lends itself to a character representation, which often makes it easier for a human to read and modify the information. Though text files contain only characters, those characters can represent a variety of information. For example, an operating system may store much of its data as text files, such as information about user accounts. A program written in a high-level language is stored as a text file, which is sometimes referred to as a *source file*. Any text editor can be used to create, view, and change the contents of a text file, no matter what specific type of information it contains.

For other information types, it is more logical and efficient to represent data by defining a specific binary format and interpretation. Only programs set up to interpret that type of data can then be used to view or modify it. For example, many types of files store image information: bitmap, GIF, JPEG, and TIFF, to name a few. As we discussed in Chapter 3, even though each stores information about an image, all of these files store that information in different ways. Their internal formats are very specific. A program must be set up to view or modify a specific type of binary file. That's why a program that can handle a GIF image may not be able to handle a TIFF image, or vice versa.

Some files you might assume to be text files actually are not. Consider, for instance, a report that you type in a word processing program and save to disk. The document is actually stored as a binary file because, in addition to the characters in the document, it contains information about formatting, styles, borders, fonts, colors, and “extras” such as graphics or clip art. Some of the data (the characters themselves) are stored as text, but the additional information requires that each word processing program have its own format for storing the data in its document files.

## File Types

Most files, whether they are in text or binary format, contain a specific type of information. For example, a file may contain a Java program, or a JPEG image, or an MP3 audio clip. Other files contain files created by specific applications, such as a Microsoft® Word document or a Visio drawing. The kind of information contained in a document is called the **file type**. Most operating systems recognize a list of specific file types.

A common mechanism for specifying a file type is to indicate the type as part of the file's name. File names are often separated, usually by a period, into two parts: the main name and the **file extension**.

**File type** The specific kind of information contained in a file, such as a Java program or a Microsoft Word document

**File extension** Part of a file name that indicates the file type



| Extensions     | File type                |
|----------------|--------------------------|
| txt            | text data file           |
| mp3, au, wav   | audio file               |
| gif, tiff, jpg | image file               |
| doc, wp3       | word processing document |
| java, c, cpp   | program source files     |

FIGURE 11.1 Some common file types and their extensions

The extension indicates the type of the file. For example, the `.java` extension in the file name `MyProg.java` indicates that it is a Java source code program file. The `.jpg` extension in the file name `family.jpg` indicates that it is a JPEG image file.

FIGURE 11.1 lists some common file extensions.

File types allow the operating system to operate on the file in ways that make sense for that file. They also usually make life easier for the user. The operating system keeps a list of recognized file types and associates each type with a particular

kind of application program. In an operating system with a graphical user interface (GUI), a particular icon is often associated with a file type as well. When you see a file in a folder, it is shown with the appropriate icon in the GUI. That makes it easier for the user to identify a file at a glance because now both the name of the file and its icon indicate which type of file it is. When you double-click on the icon to open the program, the operating system starts the program associated with that file type and loads the file.

For example, you might like a particular editor that you use when developing a Java program. You can register the `.java` file extension with the operating system and associate it with that editor. Then whenever you open a file with a `.java` extension, the operating system runs the appropriate editor. The details of how you associate an extension with an application program depend on the operating system you are using.

Some file extensions are associated with particular programs by default, which you may change if appropriate. In some cases, a file type could be associated with various types of applications, so you have some choice. For example, your system may currently associate the `.gif` extension with a particular web browser, so that when you open a GIF image file, it is displayed in that browser window. You may choose to change the association so that when you open a GIF file, it is brought into your favorite image editor instead.

A file extension is merely an indication of what the file contains. You can name a file anything you want (as long as you use the characters that the operating system allows for file names). You could give any file a `.gif` extension, for instance, but that doesn't make it a GIF image file. Changing the extension does not change the data in the file or its internal format. If you attempt to open a misnamed file in a program that expects a particular format, you will get an error message.

## File Operations

With the help of the operating system, you might perform any of several operations to and with a file:

- Create a file
- Delete a file
- Open a file
- Close a file
- Read data from a file
- Write data to a file
- Reposition the current file pointer in a file
- Append data to the end of a file
- Truncate a file (delete its contents)
- Rename a file
- Copy a file

Let's briefly examine how each of these operations is accomplished.

The operating system keeps track of secondary memory in two ways. It maintains a table indicating which blocks of memory are free (that is, available for use) and, for each directory, it maintains a table that records information about the files in that directory. To create a file, the operating system finds enough free space in the file system for the file content, puts an entry for the file in the appropriate directory table, and records the name and location of the file. To delete a file, the operating system indicates that the memory space previously used by the file is now free and removes the appropriate entry in the directory table.

Most operating systems require that a file be opened before read and write operations are performed on it. The operating system maintains a small table of all currently open files to avoid having to search for the file in the large file system every time a subsequent operation is performed. To close the file when it is no longer in active use, the operating system removes the entry in the open file table.

At any point in time, an open file has a current file pointer (an address) indicating the place where the next read or write operation should occur. Some systems keep a separate read pointer and write pointer for a file. Reading a file means that the operating system delivers a copy of the data in the file, starting at the current file pointer. After the read occurs, the file pointer is updated. When data is written to a file, the data is stored at the location indicated by the current file pointer, and then the file pointer is updated. Often an operating system allows a file to be open for reading or writing, but not for both operations at the same time.

The current file pointer for an open file might be repositioned to another location in the file to prepare for the next read or write operation. Appending

### RFID tags



As you leave a store after buying a pack of batteries, the batteries may "tell" the store's inventory system to order batteries because stock is low. Radio-frequency identification (RFID) makes this type of communication possible. In addition to items in retail stores, RFID technology is used to track shipping pallets, library books, vehicles, and animals. If you've ever used EZPass to go through a toll booth, or SpeedPass to pay for your gas, you've used RFID technology.

data to the end of a file requires that the file pointer be positioned to the end of a file; the appropriate data is then written at that location.

It is sometimes useful to “erase” the data in a file. Truncating a file means deleting the contents of the file without removing the administrative entries in the file tables. This operation avoids the need to delete a file and then recreate it. Sometimes the truncating operation is sophisticated enough to erase part of a file, from the current file pointer to the end of the file.

An operating system also provides an operation to change the name of a file, which is called *renaming the file*. Likewise, it provides the ability to create a complete copy of the contents of a file, giving the copy a new name.

## File Access

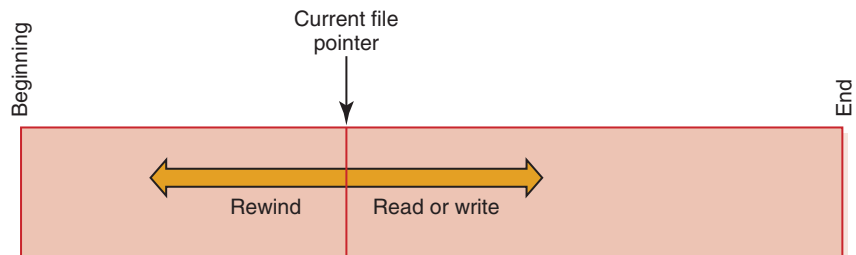
The data in a file can be accessed in several different ways. Some operating systems provide only one type of file access, whereas others provide a choice of access methods. The type of access available for a given file is established when the file is created.

Let’s examine the two primary access techniques: sequential access and direct access. The differences between these two techniques are analogous to the differences between the sequential nature of magnetic tape and the direct access offered by a magnetic disk, as discussed in Chapter 5. However, both types of files can be stored on either type of medium. File access techniques define the ways that the current file pointer can be repositioned. They are independent of the physical restrictions of the devices on which the file is stored.

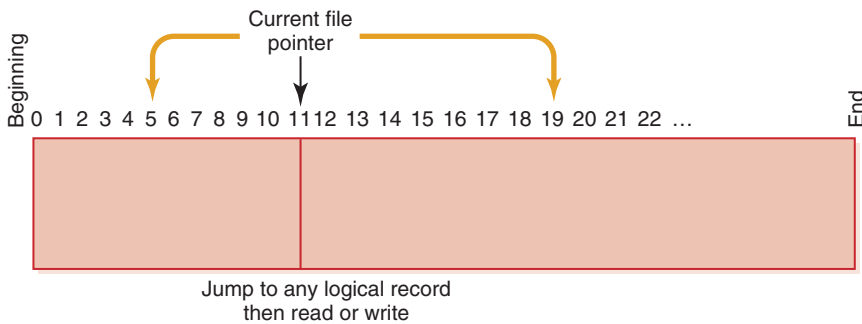
The most common access technique, and the simplest to implement, is **sequential file access**, which views the file as a linear structure. It requires that the data in the file be processed in order. Read and write operations move the current file pointer according to the amount of data that is read or written. Some systems allow the file pointer to be reset to the beginning of the file and/or to skip forward or backward by a certain number of records. See [FIGURE 11.2](#).

### Sequential file access

The technique in which data in a file is accessed in a linear fashion



**FIGURE 11.2** Sequential file access



**FIGURE 11.3** Direct file access

Files with **direct file access** are conceptually divided into numbered logical records. Direct access allows the user to set the file pointer to any particular record by specifying the record number. Therefore, the user can read and write records in any particular order desired, as shown in [FIGURE 11.3](#). Direct access files are more complicated to implement, but they are helpful in situations where specific portions of large data stores must be available quickly, such as in a database.

#### Direct file access

The technique in which data in a file is accessed directly by specifying logical record numbers

## File Protection

In multiuser systems, file protection is of primary importance. That is, we don't want one user to be able to access another user's files unless such access is specifically allowed. It is the operating system's responsibility to ensure valid file access. Different operating systems administer their file protection in different ways. In any case, a file protection mechanism determines who can use a file and for what general purpose.

For example, a file's protection settings in the UNIX operating system are divided into three categories: Owner, Group, and World. Under each category you can determine whether the file can be read, written, and/or executed. Under this mechanism, if you can write to a file, you can also delete the file.

Each file is "owned" by a particular user, who is often the creator of the file. The Owner usually has the strongest permissions regarding the file. A file may also have a group name associated with it—a group is simply a list of users. The Group permissions apply to all users in the associated group. You might create Group permissions, for instance, for all users who are working on a particular project. Finally, World permissions apply to anyone who has access to the system. Because these

permissions give access to the largest number of users, they are usually the most restricted.

In Chapter 10 we discussed the need for the operating system to protect main memory by ensuring that one program doesn't access the memory space of another. Protections are also needed in file systems to protect inappropriate access to files. Security issues at higher levels are discussed in Chapter 17.

Using this technique, the permissions on a file can be shown in a  $3 \times 3$  grid:

|       | Read | Write/Delete | Execute |
|-------|------|--------------|---------|
| Owner | Yes  | Yes          | No      |
| Group | Yes  | No           | No      |
| World | No   | No           | No      |

Suppose that this grid represents the permissions on a data file used in project Alpha. The owner of the file (perhaps the manager of the project) may read from or write to the file. Suppose also that the owner sets up a group (using the operating system) called TeamAlpha, which contains all members of the project team, and associates that group with this data file. The members of the TeamAlpha group may read the data in the file but may not change it. No one else is given any permission to access the file. Note that no user is given execute privileges for the file because it is a data file, not an executable program.

Other operating systems set up their protection schemes in different ways, but the goal is the same: to control access so as to protect against deliberate attempts to gain inappropriate access as well as minimize inadvertent problems caused by well-intentioned but hazardous users.

## 11.2 Directories

As mentioned earlier, a directory is a named collection of files. It is a way to group files so that you can organize them in a logical manner. For example, you might place all of your papers and notes for a particular class in a directory created for that class. The operating system must carefully keep track of directories and the files they contain.

A directory, in most operating systems, is represented as a file. The directory file contains data about the other files in the directory. For any given file, the directory contains the file name, the file type, the address on disk where the file is stored, and the current size of the file. The directory also contains information about the protections set up for the file.



### Hawaii panic

In January 2018, people throughout Hawaii suddenly had the following emergency alert pop up on their phones: BALLISTIC MISSILE THREAT INBOUND TO HAWAII. SEEK IMMEDIATE SHELTER. THIS IS NOT A DRILL. It took 38 minutes before the state issued a correction. It turns out the false alarm was caused by a government employee who chose the wrong menu item from a set of very similar and confusing options. User interface design is important!

In addition, it may hold information describing when the file was created and when it was last modified.

The internal structure of a directory file could be set up in a variety of ways, and we won't explore those details here. However, once it is set up, this structure must be able to support the common operations that are performed on directory files. For instance, the user must be able to list all of the files in the directory. Other common operations are creating, deleting, and renaming files within a directory. Furthermore, the directory is often searched to see whether a particular file is in the directory.

Another key issue when it comes to directory management is the need to reflect the relationships among directories, as discussed in the next section.

## Directory Trees

A directory of files can be contained within another directory. The directory containing another directory is usually called the *parent directory*, and the one inside is called a *subdirectory*. You can set up such nested directories as often as needed to help organize the file system. One directory can contain many subdirectories. Furthermore, subdirectories can contain their own subdirectories, creating a hierarchy structure. To visualize this hierarchy, a file system is often viewed as a **directory tree**, showing directories and files within other directories. The directory at the highest level is called the **root directory**. These terms are consistent with our discussion of trees as programming structures in Chapter 8.

As an example, consider the directory tree shown in [FIGURE 11.4](#). This tree represents a very small part of a file system that might be found on a computer using some flavor of the Microsoft Windows operating system. The root of the directory system is referred to using the drive letter C: followed by the backslash (\).

In this directory tree, the root directory contains three subdirectories: **WINDOWS**, **My Documents**, and **Program Files**. Within the **WINDOWS** directory, there is a file called `calc.exe`, as well as two other subdirectories (**Drivers** and **System**). Those directories contain other files and subdirectories. Keep in mind that all of these directories in a real system would typically contain many more subdirectories and files.

Personal computers often use an analogy of folders to represent the directory structure, which promotes the idea of containment (folders inside other folders, with some folders ultimately containing documents or other data). The icon used to show a directory in the graphical user interface of an operating system is often a graphic of a manila file folder such as the kind you would use in a physical file drawer.

**Directory tree** A structure showing the nested directory organization of the file system

**Root directory** The topmost directory, in which all others are contained

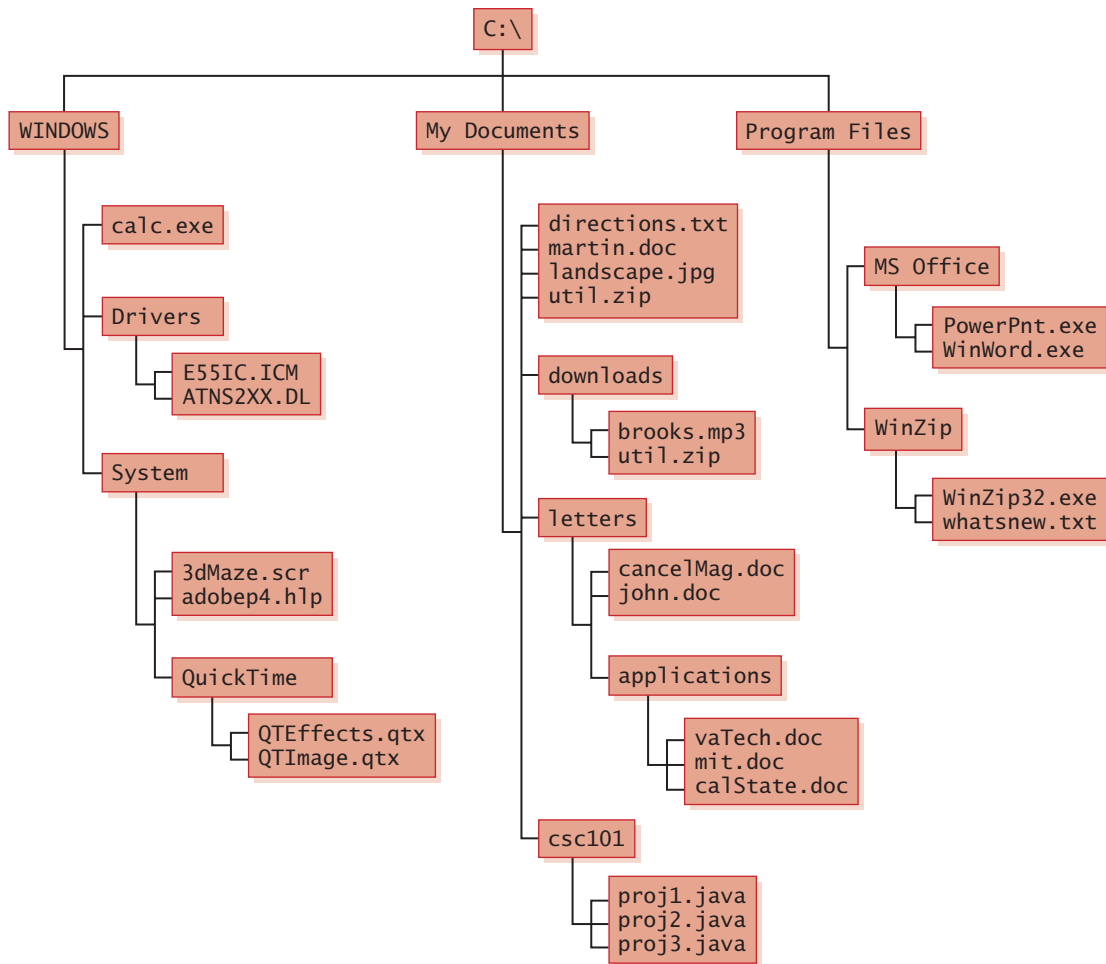


FIGURE 11.4. A Windows directory tree

In Figure 11.4, two files have the name `util.zip` (in the `My Documents` directory and in its subdirectory called `downloads`). The nested directory structure allows for multiple files to have the same name. All the files in any one directory must have unique names, but files in different directories or subdirectories can have the same name. These files may or may not contain the same data; all we know is that they have the same name.

At any point in time, you can be thought of as working in a particular location (that is, a particular subdirectory) of the file system. This subdirectory is referred to as the current **working directory**. As you “move” around in the file system, the current working directory changes.

#### Working directory

The currently active subdirectory

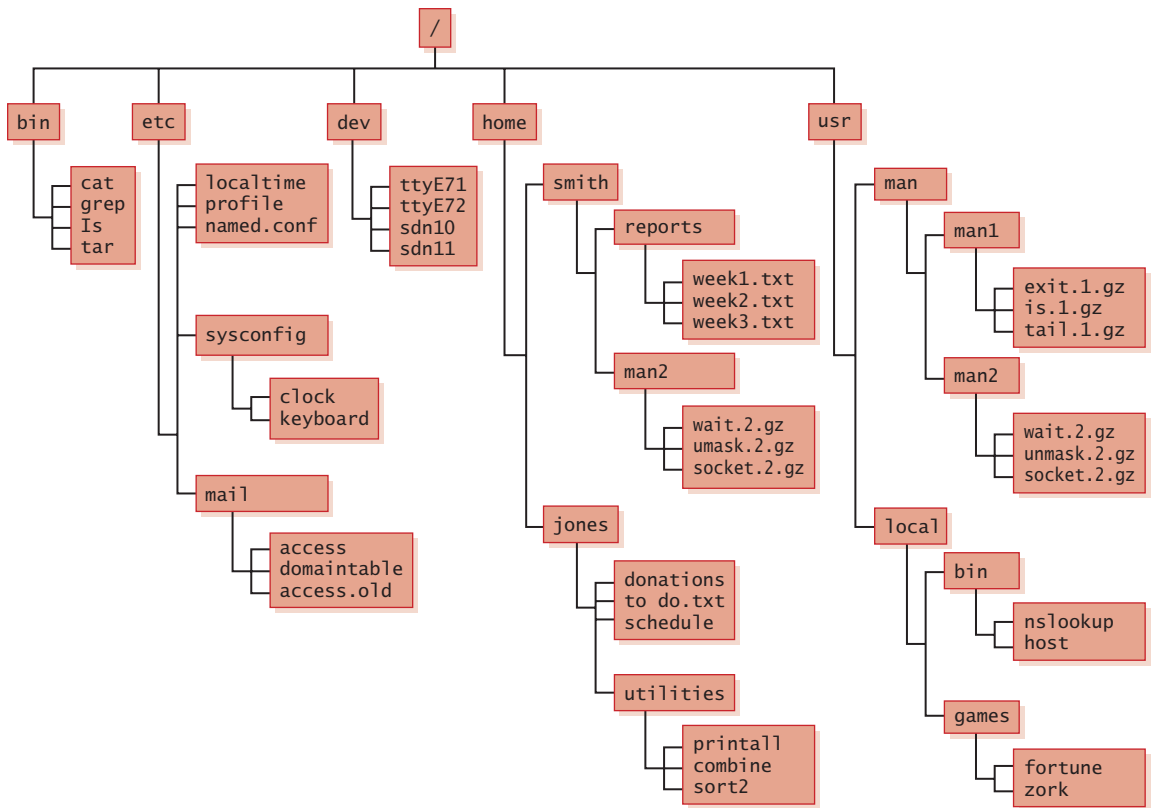


FIGURE 11.5 A UNIX directory tree

The directory tree shown in [FIGURE 11.5](#) is representative of one from a UNIX file system. Compare and contrast it to the directory tree in Figure 11.4. Both show the same concepts of subdirectory containment, but the naming conventions for files and directories are different. UNIX was developed as a programming and system-level environment, so it uses much more abbreviated and cryptic names for directories and files. Also, in a UNIX environment, the root is designated using a forward slash (/).

## Path Names

How do we specify one particular file or subdirectory? Well, there are several ways to do it.

If you are working in a graphical user interface to the operating system, you can double-click with your mouse to open a directory and see its contents. The active directory window shows the contents of the current





## RFID tags in people?

Researchers experimented with implanting RFID tags in people! In 2004, a club owner in Barcelona, Spain, and Rotterdam, the Netherlands, offered to implant his VIP customers with RFID tags. These chips identified the customers as VIPs, and the chips were used by the customers to pay for their drinks.

**Path** A text designation of the location of a file or subdirectory in a file system

**Absolute path** A path that begins at the root and includes all successive subdirectories

**Relative path** A path that begins at the current working directory

working directory. You can continue “moving” through the file system by using mouse clicks, thereby changing the current working directory, until you find the desired file or directory. To move up the directory structure, you can often use an icon on the window bar or a pop-up menu option to move to the parent directory.

Most operating systems also provide a nongraphical (text-based) interface to the operating system. Therefore, we must be able to specify file locations using text. This ability is very important for system instructions stored in operating system batch command files. Commands such as `cd` (which stands for “change directory”) can be used in text mode to change the current working directory.

To indicate a particular file using text, we specify that file’s **path**, which is the series of directories through which you must go to find the file. A path may be absolute or relative. An **absolute path** name begins at the root and specifies each step down the tree until it reaches the desired file or directory. A **relative path** name begins from the current working directory.

Let’s look at examples of each type of path. The following are absolute path names based on the directory tree shown in Figure 11.4:

```
C:\Program Files\MS Office\WinWord.exe
C:\My Documents\letters\applications\vaTech.doc
C:\Windows\System\QuickTime
```

Each path name begins at the root and proceeds down the directory structure. Each subdirectory is separated by the backslash (`\`). Note that a path can specify a specific document (as it does in the first two examples) or an entire subdirectory (as it does in the third example).

Absolute paths in a UNIX system work the same way, except that the character used to separate subdirectories is the forward slash (`/`). Here are some examples of absolute path names that correspond to the directory tree in Figure 11.5:

```
/bin/tar
/etc/sysconfig/clock
/usr/local/games/fortune
/home/smith/reports/week1.txt
```

Relative path names are based on the current working directory. That is, they are relative to your current position (hence the name). Suppose the current working directory is `C:\My Documents\letters` (from Figure 11.4). Then the following relative path names could be used:

```
cancelMag.doc
applications\calState.doc
```

The first example specifies just the name of the file, which can be found in the current working directory. The second example specifies a file in the `applications` subdirectory. By definition, the first part of any valid relative path is located in the working directory.

Sometimes when using a relative path we need to work our way back up the tree. Note that this consideration was not an issue when we used absolute paths. In most operating systems, two dots (`..`) are used to specify the parent directory (a single dot is used to specify the current working directory). Therefore, if the working directory is `C:\My Documents\Letters`, the following relative path names are also valid:

```
..\landscape.jpg
..\csc111\proj2.java
..\..\WINDOWS\Drivers\E55IC.ICM
..\..\Program Files\WinZip
```

UNIX systems work essentially the same way. Using the directory tree in Figure 11.5, and assuming that the current working directory is `/home/jones`, the following are valid relative path names:

```
utilities/combine
../smith/reports
../../dev/ttyE71
../../usr/man/man1/lis.1.gz
```

Most operating systems allow the user to specify a set of paths that are searched (in a specific order) to help resolve references to executable programs. Often that set of paths is specified using an operating system variable called `PATH`, which holds a string that contains several absolute path names. Suppose, for instance, that user `jones` (from Figure 11.5) has a set of utility programs that he uses from time to time. They are stored in the directory `/home/jones/utilities`. When that path is added to the `PATH` variable, it becomes a standard location used to find programs that `jones` attempts to execute. Therefore, no matter what the current working directory is, when `jones` executes the `printall` program (just the name by itself), it is found in his utilities directory.

## 11.3 Disk Scheduling

The most important hardware device used as secondary memory is the magnetic disk drive. File systems stored on these drives must be accessed in an efficient manner. It turns out that transferring data to and from secondary memory is the worst bottleneck in a general computer system.

Recall from Chapter 10 that the speed of the CPU and the speed of main memory are much faster than the speed of data transfer to and from

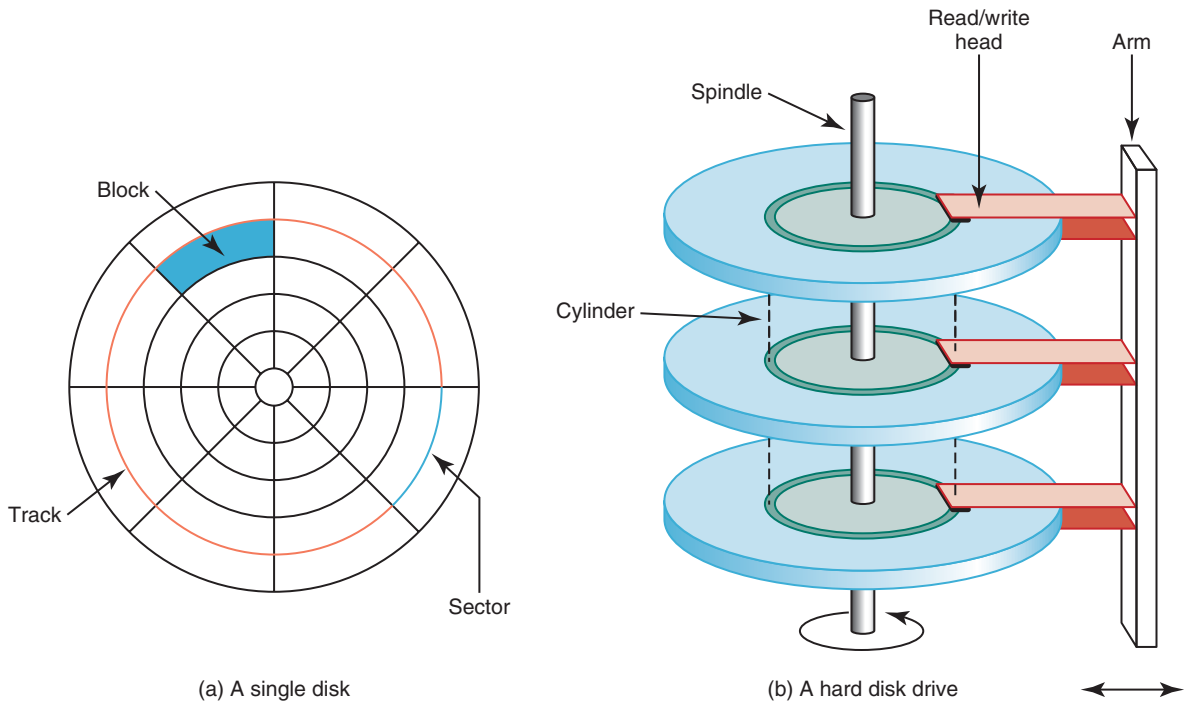
secondary memory such as a magnetic disk. That's why a process that must perform I/O to disk is made to wait while that data is transferred, to give another process a chance to use the CPU.

Because secondary I/O is the slowest aspect of a general computer system, the techniques for accessing data on a disk drive are of crucial importance to file systems. As a computer deals with multiple processes over a period of time, requests to access the disk accumulate. The technique that the operating system uses to determine which requests to satisfy first is called **disk scheduling**. We examine several specific disk-scheduling algorithms in this section.

Recall from Chapter 5 that a magnetic disk drive is organized as a stack of platters, where each platter is divided into tracks, and each track is divided into sectors. The set of corresponding tracks on all platters is called a *cylinder*. **FIGURE 11.6** revisits the disk drive depicted in Chapter 5 to remind you of this organization.

Of primary importance to us in this discussion is the fact that the set of read/write heads hovers over a particular cylinder along all platters at any given point in time. The *seek time* is the amount of time it takes for the heads to reach the appropriate cylinder. The *latency* is the additional time it takes the platter to rotate into the proper position so that the data can be read

**Disk scheduling** The act of deciding which outstanding requests for disk I/O to satisfy first



**FIGURE 11.6** A magnetic disk drive

or written. Seek time is the more restrictive of these two parameters and, therefore, is the primary issue dealt with by the disk-scheduling algorithms.

At any point in time, a disk drive may have a set of outstanding requests that must be satisfied. For now, we consider only the cylinder (the parallel concentric circles) to which the requests refer. A disk may have thousands of cylinders. To keep things simple, let's also assume a range of 110 cylinders. Suppose at a particular time the following cylinder requests have been made, in this order:

49, 91, 22, 61, 7, 62, 33, 35

Suppose also that the read/write heads are currently at cylinder 26. Now a question arises: To which cylinder should the disk heads move next? Different algorithms produce different answers to this question.

## First-Come, First-Served Disk Scheduling

In Chapter 10 we examined a CPU-scheduling algorithm called *first come, first served* (FCFS). An analogous algorithm can be used for disk scheduling. It is one of the easiest to implement, though not usually the most efficient.

In FCFS, we process the requests in the order they arrive, without regard to the current position of the heads. Therefore, under a FCFS algorithm, the heads move from cylinder 26 (the current position) to cylinder 49. After the request for cylinder 49 is satisfied (that is, the data is read or written), the heads move from 49 to 91. After processing the request at 91, the heads move to cylinder 22. Processing continues in this manner, satisfying requests in the order that they were received.

Note that at one point the heads move from cylinder 91 all the way back to cylinder 22, during which they pass over several cylinders whose requests are currently pending.

## Shortest-Seek-Time-First Disk Scheduling

The *shortest-seek-time-first* (SSTF) disk-scheduling algorithm moves the heads by the minimum amount necessary to satisfy any pending request. This approach could potentially result in the heads changing directions after each request is satisfied.

Let's process our hypothetical situation using this algorithm. From our starting point at cylinder 26, the closest cylinder among all pending requests is 22. So, ignoring the order in which the requests came, the heads move to cylinder 22 to satisfy that request. From 22, the closest request is for cylinder 33, so the heads move there. The closest unsatisfied request to 33 is at cylinder 35. The distance to cylinder 49 is now the

### Soothing software

?

Chronic stress can lead to cardiovascular disease, diabetes, impaired cognitive function, and a weakened immune system. One measure of stress level is heart rate variability (HRV), the period in milliseconds between heartbeats that cardiologists study in at-risk patients. In a healthy person, HRV should be high but within a certain zone. One software package that measures HRV is supplied by HeartMath®. The emWave® measures stress with a finger or ear sensor that detects the user's pulse. Just a few minutes of breathing with the emWave's pacer and thinking positive thoughts can bring HRV into the target zone.

smallest, so the heads move there next. Continuing that approach, the rest of the cylinders are visited in the following order: 49, 61, 62, 91, 7.

This approach does not guarantee the smallest overall head movement, but it generally offers an improvement in performance over the FCFS algorithm. However, a major problem can arise with this approach. Suppose requests for cylinders continue to build up while existing ones are being satisfied. And suppose those new requests are always closer to the current position than an earlier request. It is theoretically possible that the early request never gets processed because requests keep arriving that take priority. This situation is called *starvation*. By contrast, FCFS disk scheduling cannot suffer from starvation.

## SCAN Disk Scheduling

A classic example of algorithm analysis in computing comes from the way an elevator is designed to visit floors that have people waiting. In general, an elevator moves from one extreme to the other (say, the top of the building to the bottom), servicing requests as appropriate. It then travels from the bottom to the top, servicing those requests.

The *SCAN* disk-scheduling algorithm works in a similar way, except that instead of moving up and down, the read/write heads move in toward the spindle, then out toward the platter edge, then back toward the spindle, and so forth.

Let's use this algorithm to satisfy our set of requests. Unlike in the other approaches, though, we need to decide which way the heads are moving initially. Let's assume they are moving toward the lower cylinder values (and are currently at cylinder 26).

As the read/write heads move from cylinder 26 toward cylinder 1, they satisfy the requests at cylinders 22 and 7 (in that order). After reaching cylinder 1, the heads reverse direction and move all the way out to the other extreme. Along the way, they satisfy the following requests, in order: 33, 35, 49, 61, 62, 91.

New requests are not given any special treatment under this scheme. They may or may not be serviced before earlier requests—it depends on the current location of the heads and direction in which they are moving. If a new request arrives just before the heads reach that cylinder, it is processed right away. If it arrives just after the heads move past that cylinder, it must wait for the heads to return. There is no chance for starvation because each cylinder is processed in turn.

Some variations on this algorithm can improve its performance. For example, a request at the edge of the platter may have to wait for the heads

### ?

#### Keeping the elderly at home

Many new technologies are being developed to make it easier for elderly people to continue living independent lives at home. One example is the eNeighbor<sup>®</sup> system, a system with 12 kinds of sensors (e.g., bed, toilet flush, home away, open/closed) and an optional web camera. Changes in a person's habits (if a person falls down and does not move in his or her regular pattern, for example) will be relayed to a central monitoring system. An operator then calls the house to ask if the patient is okay. If no response is received, the family, a neighbor, or 911 is called.

© Artur Debat/Getty Images; © Alan Dyer/Stocktrek Images/Getty Images

## Tony Hoare

Tony Hoare's interest in computing was awakened in the early 1950s, when he studied philosophy (together with Latin and Greek) at Oxford University under the tutelage of John Lucas. He was fascinated by the power of mathematical logic as an explanation of the apparent certainty of mathematical truth. During his National Service (1956–1958), he studied Russian in the Royal Navy. Then he took a qualification in statistics, and incidentally a course in programming given by Leslie Fox. In 1959, as a graduate student at Moscow State University, he studied the machine translation of languages (together with probability theory) in the school of Kolmogorov. To assist in efficient lookup of words in a dictionary, he discovered the well-known sorting algorithm Quicksort.

On return to England in 1960, he worked as a programmer for Elliott Brothers, a small scientific computer manufacturer. He led a team (including his later wife, Jill) in the design and delivery of the first commercial compiler for the programming language ALGOL 60. He attributes the success of the project to the use of ALGOL itself as the design language for the compiler, although the implementation used decimal machine code. Promoted to the rank of chief engineer, he then led a larger team on a disastrous project to implement an operating system. After managing a recovery from the failure, he moved as chief scientist to the computing research division, where he worked on the hardware and software architecture for future machines.

These machines were cancelled when the company merged with its rivals, and in 1968 Tony took a chance to apply for the Professorship of Computing Science at the Queen's University, Belfast. His research goal was to understand why operating systems were so much more difficult than compilers, and to see if advances in programming theory and languages could help with the problems of concurrency. In spite of civil disturbances, he built up a strong teaching and research department and published a series of papers on the use of assertions to prove correctness of computer programs. He knew that this was long-term research, unlikely to achieve industrial application within the span of his academic career.

In 1977 he moved to Oxford University and undertook to build up the Programming Research Group, founded by Christopher Strachey. With the aid of external funding from government initiatives, industrial collaborations, and charitable donations, Oxford now teaches a range of degree courses in computer science, including an external master's degree for software engineers from industry. The research of his teams at Oxford pursued an ideal that takes provable correctness as the driving force for the accurate specification, design, and development of computing systems, both critical and noncritical. Well-known results of the research include the Z specification language and the CSP concurrent programming model. A recent personal research goal has been



Courtesy of Inamori Foundation



© Artur Debat/Getty Images; © Alan Dyer/Stocktrek Images/Getty Images

## Tony Hoare (continued)

the unification of a diverse range of theories applying to different programming languages, paradigms, and implementation technologies.

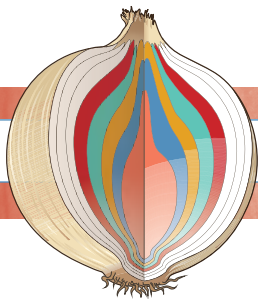
Throughout more than 30 years as an academic, Tony has maintained strong contacts with industry through consultation, teaching, and collaborative research projects. He took a particular interest in the sustenance of legacy code, where assertions are now playing a vital role, not for his original purpose of program proof, but rather in instrumentation of code for testing purposes. On reaching retirement age at Oxford, he welcomed an opportunity to return to industry as a senior researcher with Microsoft

Research in Cambridge. He hopes to expand the opportunities for industrial application of good academic research and to encourage academic researchers to continue the pursuit of deep and interesting questions in areas of long-term interest to the software industry and its customers.

*Note: This biographical sketch was written by Sir Tony Hoare himself and reprinted with his permission. What he does not say is that he received the Turing Award in 1980 for his fundamental contributions to the definition and design of programming languages, and he was awarded a Knighthood in 1999 for his services to education and computer science.*

to move almost all the way to the spindle and all the way back. To improve the average wait time, the Circular SCAN algorithm treats the disk as if it were a ring and not a disk. That is, when it reaches one extreme, the heads return all the way to the other extreme without processing requests.

Another variation is to minimize the extreme movements at the spindle and at the edge of the platter. Instead of going to the edge, the heads move only as far out (or in) as the outermost (or innermost) request. Before moving on to tackle the next request, the list of pending requests is examined to see whether movement in the current direction is warranted. This variation is referred to as the *LOOK* disk-scheduling algorithm, because it looks ahead to see whether the heads should continue in the current direction.



© Artur Debat/Getty Images; © Alan Dyer/Stocktrek Images/Getty Images

## SUMMARY

A file system defines the way our secondary memory is organized. A file is a named collection of data with a particular internal structure. Text files are organized as a stream of characters; binary files have a particular format that is meaningful only to applications set up to handle that format.

File types are often indicated by the file extension of the file name. The operating system maintains a list of recognized file types so that it may open them in the correct kind of application and display the appropriate icons in the graphical user interface. The file extension can be associated with any particular kind of application that the user chooses.

The operations performed on files include creating, deleting, opening, and closing files. Of course, files must be able to be read from and written to as well. The operating system provides mechanisms to accomplish the various file operations. In a multiuser system, the operating system must also provide file protection to ensure that only authorized users have access to files.

Directories are used to organize files on disk. They can be nested to form hierarchical tree structures. Path names that specify the location of a particular file or directory can be absolute, originating at the root of the directory tree, or relative, originating at the current working directory.

Disk-scheduling algorithms determine the order in which pending disk requests are processed. First-come, first-served disk scheduling takes all requests in order but is not very efficient. Shortest-seek-time-first disk scheduling is more efficient but could suffer from starvation. SCAN disk scheduling employs the same strategy as an elevator, sweeping from one end of the disk to the other.





## ETHICAL ISSUES

### Privacy: Opt-In or Opt-Out?<sup>1,2</sup>

These terms—*opt-in* and *opt-out*—refer to privacy policies. When you sign up at a banking institution, do you want the bank to share your information with other financial institutions? If you buy an item on the Internet from Company A, do you want to receive email from a similar Company B? When you apply for a credit card, do you want to get offers from other credit card companies?

*Opt-in* says that you must explicitly say you want to share your information. *Opt-out* says that the information will be shared unless you explicitly say you do not want to share your information. That is, a website's default is either opt-in or opt-out.

In the United States, the CAN-SPAM Act covers commercial email messages; the E.U. directive covers all email marketing messages in the European Union. The CAN-SPAM Act allows direct marketing to anyone until the recipient requests the email to stop (the default is opt-in; you must check a box to opt-out). The E.U. directive says that email can only be sent to subscribers who have given their prior consent (the default is opt-out; you must check a box to opt-in). Companies using opt-out must give the recipients a way to cancel the emails.

The different approaches to privacy, evidenced by how the United States and E.U. handle email, has surfaced in other areas. One of the authors went online, Googled their own name, and received over 7 million hits in 0.23 seconds. The Spanish government has ordered Google to stop indexing information about 90 citizens who filed a formal complaint. In 2012, the E.U. adopted a “right to be forgotten” regulation. In contrast, U.S. courts have consistently found that the right to publish the truth supersedes any right to privacy.

Parallel questions are: Should the people in pictures posted on the Internet be identified without the person's consent? Should cyber maps give pictures of a residence without the owner's consent? In the United States, Facebook announced that it was changing its policy of posting names without consent. In Germany, Google allowed individuals and businesses to opt out of Street View. Approximately 250,000 people have done so. These issues have not been, nor will they be, decided easily or quickly.

## KEY TERMS

Absolute path  
Binary file  
Direct file access  
Directory  
Directory tree  
Disk scheduling  
File  
File extension

File system  
File type  
Path  
Relative path  
Root directory  
Sequential file access  
Text file  
Working directory

## EXERCISES

For Exercises 1–15, mark the answers true or false as follows:

- A. True
  - B. False
1. A text file stores binary data that is organized into groups of 8 or 16 bits that are interpreted as characters.
  2. A program written in a high-level language is stored in a text file that is also called a *source file*.
  3. The type of a file determines which kinds of operations can be performed on it.
  4. The current file pointer indicates the end of a file.
  5. Sequential access and direct access take about the same amount of time to retrieve data.
  6. Some operating systems maintain a separate read pointer and write pointer for a file.
  7. UNIX file permissions allow a group of users to access a file in various ways.
  8. In most operating systems, a directory is represented as a file.
  9. Two files in a directory system can have the same name if they are in different directories.
  10. A relative path is relative to the root of the directory hierarchy.
  11. An absolute path and a relative path will always be the same length.
  12. An operating system is responsible for managing the access to a disk drive.

**EXERCISES (CONTINUED)**

13. The seek time is the amount of time it takes for the heads of a disk to reach a particular cylinder.
14. The shortest-seek-time-first disk-scheduling algorithm moves the heads the minimum amount it can to satisfy a pending request.
15. The first-come, first-served disk-scheduling algorithm moves the heads the minimum amount it can to satisfy a pending request.

For Exercises 16–20, match the file extensions with the appropriate file.

- A. `.txt`
  - B. `.mp3`, `.au`, and `.wav`
  - C. `.gif`, `.tiff`, and `.jpg`
  - D. `.doc` and `.wp3`
  - E. `.java`, `.c`, and `.cpp`
16. Audio file
  17. Image file
  18. Text data file
  19. Program source file
  20. Word processing file

For Exercises 21–23, match the symbol with its use.

- A. `/`
  - B. `\`
  - C. `..`
21. Symbol used to separate the names in a path in a Windows environment
  22. Symbol used to separate the names in a path in a UNIX environment
  23. Symbol used to represent the parent directory in a relative path name

Exercises 24–57 are problems or short-answer questions.

24. What is a file?
25. Distinguish between a file and a directory.
26. Distinguish between a file and a file system.
27. Why is a file a generic concept and not a technical one?
28. Name and describe the two basic classifications of files.
29. Why is the term *binary file* a misnomer?
30. Distinguish between a file type and a file extension.
31. What would happen if you gave the name `myFile.jpg` to a text file?
32. How can an operating system make use of the file types that it recognizes?
33. How does an operating system keep track of secondary memory?
34. What does it mean to open and close a file?
35. What does it mean to truncate a file?
36. Compare and contrast sequential and direct file access.
37. File access is independent of any physical medium.
  - a. How could you implement sequential access on a disk?
  - b. How could you implement direct access on a magnetic tape?
38. What is a file protection mechanism?
39. How does UNIX implement file protection?

**EXERCISES (CONTINUED)**

40. Given the following file permission, answer these questions.

|       | Read | Write/Delete | Execute |
|-------|------|--------------|---------|
| Owner | Yes  | Yes          | Yes     |
| Group | Yes  | Yes          | No      |
| World | Yes  | No           | No      |

- a. Who can read the file?
  - b. Who can write or delete the file?
  - c. Who can execute the file?
  - d. What do you know about the content of the file?
41. What is the minimum amount of information a directory must contain about each file?
42. How do most operating systems represent a directory?
43. Answer the following questions about directories.
- a. A directory that contains another directory is called what?
  - b. A directory contained within another directory is called what?
  - c. A directory that is not contained in any other directory is called what?
  - d. The structure showing the nested directory organization is called what?
  - e. Relate the structure in (d) to the binary tree data structure examined in Chapter 8.
44. What is the directory called in which you are working at any one moment?
45. What is a path?
46. Distinguish between an absolute path and a relative path.
47. Show the absolute path to each of the following files or directories using the directory tree shown in Figure 11.4:
- a. `QTEffects.qtx`
  - b. `brooks.mp3`
  - c. `Program Files`
  - d. `3dMaze.scr`
  - e. `Powerpnt.exe`
48. Show the absolute path to each of the following files or directories using the directory tree shown in Figure 11.5:
- a. `tar`
  - b. `access.old`
  - c. `named.conf`
  - d. `smith`
  - e. `week3.txt`
  - f. `printall`
49. Assuming the current working directory is `C:\WINDOWS\System`, give the relative path name to the following files or directories using the directory tree shown in Figure 11.4:
- a. `QTImage.qtx`
  - b. `calc.exe`
  - c. `letters`
  - d. `proj3.java`
  - e. `adobep4.hlp`
  - f. `WinWord.exe`
50. Show the relative path to each of the following files or directories

**EXERCISES (CONTINUED)**

using the directory tree shown in Figure 11.5:

- a. `localtime` when working directory is the root directory
  - b. `localtime` when the working directory is `etc`
  - c. `printall` when the working directory is `utilities`
  - d. `week1.txt` when the working directory is `man2`
51. What is the worst bottleneck in a computer system?
  52. Why is disk scheduling concerned more with cylinders than with tracks and sectors?
  53. Name and describe three disk scheduling algorithms.

Use the following list of cylinder requests in Exercises 54–56. They are

listed in the order in which they were received.

40, 12, 22, 66, 67, 33, 80

54. List the order in which these requests are handled if the FCFS algorithm is used. Assume that the disk is positioned at cylinder 50.
55. List the order in which these requests are handled if the SSTF algorithm is used. Assume that the disk is positioned at cylinder 50.
56. List the order in which these requests are handled if the SCAN algorithm is used. Assume that the disk is positioned at cylinder 50 and the read/write heads are moving toward the higher cylinder numbers.
57. Explain the concept of starvation.

## THOUGHT QUESTIONS

1. The concept of a file permeates computing. Would the computer be useful if there were no secondary memory on which to store files?
2. The disk scheduling algorithms examined in this chapter sound familiar. In what other context have we discussed similar algorithms? How are these similar and how are they different?
3. Are there any analogies between files and directories and file folders and filing cabinets? Clearly, the term “file” came from this concept. Where does this analogy hold true and where does it not?
4. Spamming is the Internet equivalent of unsolicited telephone sales pitches. There are laws now that allow a telephone user to request that his or her name be removed from the solicitor’s calling list. Should there be similar laws relating to spamming?
5. In your opinion, is spamming a reasonable business strategy, like regular direct or “junk” mail, or is it a form of electronic harassment? Why or why not?
6. Which approach is better, opt-in or opt-out?

## Laying the Groundwork

- 1 The Big Picture

## The Information Layer

- 2 Binary Values and Number Systems
- 3 Data Representation

## The Hardware Layer

- 4 Gates and Circuits
- 5 Computing Components

## The Programming Layer

- 6 Low-Level Programming Languages and Pseudocode
- 7 Problem Solving and Algorithms
- 8 Abstract Data Types and Subprograms
- 9 Object-Oriented Design and High-Level Programming Languages

## The Operating Systems Layer

- 10 Operating Systems
- 11 File Systems and Directories

## The Applications Layer

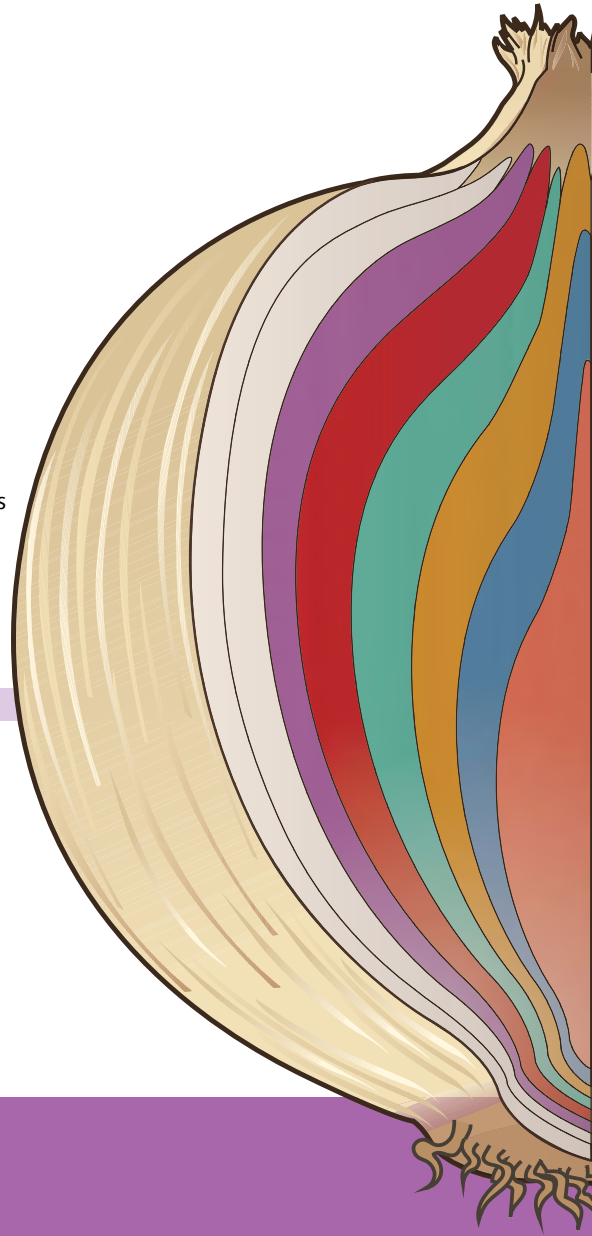
- 12 Information Systems
- 13 Artificial Intelligence
- 14 Simulation, Graphics, Gaming, and Other Applications

## The Communications Layer

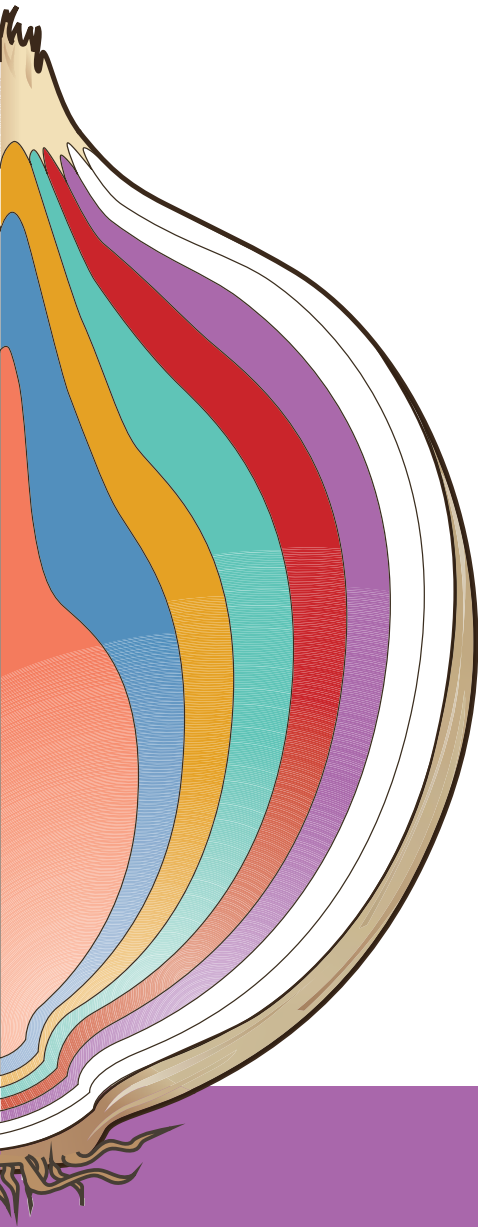
- 15 Networks
- 16 The World Wide Web
- 17 Computer Security

## In Conclusion

- 18 Limitations of Computing



# THE APPLICATIONS LAYER



## 12

# INFORMATION SYSTEMS

Most people interact with computers at the application level. That is, even if a person doesn't know anything about the details of the other underlying levels of computing, the chances are that he or she has used application software. Our goal at this level is to give you an appreciation for how various application systems work. Application software can be classified in several ways. In this chapter we focus on general information systems. In Chapter 13 we discuss applications in the realm of artificial intelligence, and in Chapter 14 we focus on simulations, graphics, and gaming.

Computers exist to manage and analyze data. Today they affect almost all aspects of our lives. We use general information systems to manage everything from sports statistics to payroll data. Likewise, cash registers and ATMs are supported by large information systems. In this chapter we examine general-purpose software, particularly spreadsheets and database management systems; these help us organize and analyze the huge amounts of data with which we must deal.

## GOALS

After studying this chapter, you should be able to:

- define the role of general information systems.
- explain how spreadsheets are organized.
- create spreadsheets for basic analysis of data.
- define appropriate spreadsheet formulas using built-in functions.
- design spreadsheets to be flexible and extensible.
- describe the elements of a database management system.
- describe the organization of a relational database.
- establish relationships among elements in a database.
- write basic SQL statements.
- describe an entity-relationship diagram.
- define and explain the role of e-commerce in society today.



**Information system**

Software that helps the user organize and analyze data

## 12.1 Managing Information

In this book we've used the term *data* to describe raw facts and *information* to mean data that has been organized to help us answer questions and solve problems. An **information system** can be generally defined as software that helps us organize and analyze data.

Turning data into information requires taking raw data sources and organizing them into a useful form. The data may have to be classified, clustered, and transformed in various ways to make it meaningful. These are all activities of an information system.

Often, managing information cannot be done alone. It's typically a collaborative process, working with colleagues and data experts to understand the sources of data and its importance from various perspectives. It's rare for one person to have the understanding necessary to test the relevant hypotheses and interpret the results. You may tend to think of data analysis as a nerdy, solo activity, but the truth is it often takes many people to provide the insight needed. A good information system, therefore, helps support such collaboration.

Any particular application program manages data, and some programs manage data in particular ways using particular structures. Other specialized applications use specific techniques that are geared toward the type of problems they are trying to solve. For example, as we discuss in the next chapter, data can be organized so as to support the analysis that typically occurs in the computing field of artificial intelligence.

Most situations, however, are more general. In fact, innumerable situations don't require any special consideration. We simply have data to manage and relationships within that data to capture. These situations don't necessarily require special organization or processing. What they do require, however, are flexible application software tools that allow the user to dictate and manage the organization of data, and that have basic processing capabilities to analyze the data in various ways.

Three of the most popular general application information systems are *electronic spreadsheets*, *database management systems*, and *e-commerce*. A spreadsheet is a convenient tool for basic data analysis based on extensible formulas that define relationships among the data. Database management systems are geared toward managing large amounts of data that are often searched and organized into appropriate subsections.

Entire books have been written about spreadsheets and how they are set up and used. The same can be said for database management systems. Our goal for this chapter is not to exhaustively explore either of these systems, but rather to introduce the usefulness and versatility of both. After this

**Ellis Island**

The Ellis Island Immigration Station processed arriving immigrants between 1892 and 1954. The Ellis Island website ([www.ellisland.org](http://www.ellisland.org)) has a searchable database that includes the name, age, country of origin, and even the ship on which each of the 25 million passengers arrived in the United States. It has been estimated that 40% of all current U.S. citizens can trace at least one of their ancestors to Ellis Island.

discussion you should be able to create basic versions of either type of system, and you will have a foundation on which to explore them in more detail.

Spreadsheets and database management systems have been around since the 1970s. Electronic commerce, by comparison, is newer, coming about with the advent of the World Wide Web. These systems manage all aspects of buying and selling on the Internet.

## 12.2 Spreadsheets

A variety of spreadsheet programs are available today. You may already have some experience with spreadsheets, though we don't assume any background knowledge in this discussion. Each spreadsheet program has its own particular nuances regarding its abilities and syntax, but all spreadsheets embrace a common set of concepts. Our discussion in this chapter focuses on these common concepts. The specific examples that we explore are consistent with the syntax and functionality of the Microsoft Excel spreadsheet program.

A **spreadsheet** is a software application that allows the user to organize and analyze data using a grid of labeled **cells**. A cell can contain data or a formula that is used to calculate a value. Data stored in a cell can be text, numbers, or "special" data such as dates.

As shown in **FIGURE 12.1**, spreadsheet cells are referenced by their row and column designation, usually using letters to specify the column and numbers to specify the row. Thus we refer to cells as, for example, A1, C7, and G45. After the 26th column, spreadsheets begin to use two letters for the column designation, so some cells have designations such as AA19. There is usually some reasonably large maximum number of rows in a spreadsheet, such as 256. Furthermore, in most spreadsheet programs, multiple sheets can be combined into one large interacting system.

|   | A | B | C | D |
|---|---|---|---|---|
| 1 |   |   |   |   |
| 2 |   |   |   |   |
| 3 |   |   |   |   |
| 4 |   |   |   |   |
| 5 |   |   |   |   |

**FIGURE 12.1** A spreadsheet, made up of a grid of labeled cells

**Spreadsheet** A program that allows the user to organize and analyze data using a grid of cells

**Cell** An element of a spreadsheet that can contain data or a formula

|    | A    | B     | C     | D     | E     | F     | G     | H |
|----|------|-------|-------|-------|-------|-------|-------|---|
| 1  |      |       |       |       |       |       |       |   |
| 2  |      |       |       | Tutor |       |       |       |   |
| 3  |      |       | Hal   | Amy   | Frank | Total | Avg   |   |
| 4  |      | 1     | 12    | 10    | 13    | 35    | 11.67 |   |
| 5  |      | 2     | 14    | 16    | 16    | 46    | 15.33 |   |
| 6  | Week | 3     | 10    | 18    | 13    | 41    | 13.67 |   |
| 7  |      | 4     | 8     | 21    | 18    | 47    | 15.67 |   |
| 8  |      | 5     | 15    | 18    | 12    | 45    | 15.00 |   |
| 9  |      | Total | 59    | 83    | 72    | 214   | 71.33 |   |
| 10 |      | Avg   | 11.80 | 16.60 | 14.40 | 42.80 | 14.27 |   |
| 11 |      |       |       |       |       |       |       |   |
| 12 |      |       |       |       |       |       |       |   |

FIGURE 12.2 A spreadsheet containing data and computations

Spreadsheets are useful in many situations, and they are often designed to manage thousands of data values and calculations. Let's look at a small example that demonstrates fundamental spreadsheet principles. Suppose we have collected data on the number of students who came to get help from a set of tutors over a period of several weeks. We've kept track of how many students went to each of three tutors (Hal, Amy, and Frank) each week for a period of five weeks. Now we want to perform some basic analysis on that data. We might end up with the spreadsheet shown in [FIGURE 12.2](#).

This spreadsheet contains, among other things, the raw data to be analyzed. Cell C4, for instance, contains the number of students whom Hal tutored in week 1. The column of data running from C4 to C8 contains the number of students tutored by Hal in each of the five weeks during which data was collected. Likewise, the data for Amy is stored in cells D4 through D8, and the data for Frank is stored in cells E4 through E8. This same data can be thought of in terms of the row it is in. Each row shows the number of students helped by each tutor in any given week.

In cells C9, D9, and E9, the spreadsheet computes and displays the total number of students helped by each tutor over all five weeks. In cells C10, D10, and E10, the spreadsheet also computes and displays the average number of students helped by each tutor each week. Likewise, the total number of students helped each week (by all tutors) is shown in

the column of cells running from F4 to F8. The average number of students helped per week is shown in cells G4 to G8.

In addition to the totals and averages per tutor and per week, the spreadsheet calculates some other overall statistics. Cell F9 shows the total number of students helped by all tutors in all weeks. The average per week (for all tutors) is shown in cell F10, and the average per tutor (for all weeks) is shown in cell G9. Finally, the average number of students helped by any tutor in any week is shown in cell G10.

The data stored in columns A and B and in rows 2 and 3 are simply used as labels to indicate what the values in the rest of the spreadsheet represent. These labels are meant to enhance the spreadsheet's human readability only and do not contribute to the calculations.

Note that the labels and some of the values in the spreadsheet in Figure 12.2 are shown in different colors. Most spreadsheet programs allow the user to control the look and format of the data in specific cells in various ways. The user can specify the font, style, and color of the data as well as the alignment of the data within the cell (such as centered or left justified). In the case of real numeric values, such as the averages computed in this example, the user can specify how many decimal places should be displayed. In most spreadsheet programs, the user can also dictate whether the grid lines for each cell are displayed or remain invisible (in this example they are all displayed) and what the background color or pattern of a cell should be. All of these user preferences are specified with menu options or buttons in the spreadsheet application software.

## Spreadsheet Formulas

In our example spreadsheet, we performed several calculations that gave us insight into the overall situation regarding tutor support. It turns out that it is relatively easy to set up these calculations. You might say that it wouldn't take long to sit down with these numbers and produce the same statistics with a calculator, and you would be right. However, the beauty of a spreadsheet is that it is both easily modified and easily expanded.

If we've set up the spreadsheet correctly, we could add or remove tutors, add additional weeks of data, or change any of the data we have already stored—and the corresponding calculations would automatically be updated. For example, although we set up the tutor spreadsheet to use the data of three tutors, the same spreadsheet could be expanded to handle hundreds of tutors. Instead of five weeks of data, we could just as easily process a year's worth.

The power of spreadsheets comes from the formulas that we can create and store in cells. All of the totals and averages in the example in

|    | A    | B     | C     | D     | E     | F     | G     | H                 |
|----|------|-------|-------|-------|-------|-------|-------|-------------------|
| 1  |      |       |       |       |       |       |       |                   |
| 2  |      |       |       | Tutor |       |       |       |                   |
| 3  |      |       | Hal   | Amy   | Frank | Total | Avg   |                   |
| 4  |      | 1     | 12    | 10    | 13    | 35    | 11.67 |                   |
| 5  |      | 2     | 14    | 16    | 16    | 46    | 15.33 |                   |
| 6  | Week | 3     | 10    | 18    | 13    | 41    | 13.67 | =SUM(C4..E4)      |
| 7  |      | 4     | 8     | 21    | 18    | 47    | 15.67 |                   |
| 8  |      | 5     | 15    | 18    | 12    | 45    | 15.00 | =F7/COUNT(C7..E7) |
| 9  |      | Total | 59    | 83    | 72    | 214   | 71.33 |                   |
| 10 |      | Avg   | 11.80 | 16.60 | 14.40 | 42.80 | 14.27 | =F9/COUNT(C4..E8) |
| 11 |      |       |       |       |       |       |       |                   |
| 12 |      |       |       |       |       |       |       |                   |

=SUM(C4..C8)      =E9/COUNT(E4..E8)

FIGURE 12.3 The formulas behind some of the cells

Figure 12.2 are computed using formulas. When a formula is stored in a cell, the result of the formula is displayed in the cell. Therefore, when we look at the values in a spreadsheet, it is sometimes challenging to tell whether the data shown in a particular cell was entered directly or computed by an underlying formula.

FIGURE 12.3 shows the same spreadsheet as Figure 12.2, indicating the formulas underlying some of the cells. Formulas in our examples (as in many spreadsheet programs) begin with an equal sign (=). That's how the spreadsheet knows which cells contain formulas that must be evaluated.

The formulas in this example refer to particular cells (by their column and row designation). When a formula is evaluated, the values stored in the referenced cells are used to compute the result. Formulas in a spreadsheet are reevaluated whenever the spreadsheet changes; therefore, the results are always kept current. A spreadsheet is dynamic—it responds to changes immediately. If we changed the number of students whom Frank tutored in week 2, the totals and averages that use that value would be recalculated immediately to reflect the revised data.

Formulas can make use of basic arithmetic operations using the standard symbols (+, −, \*, and /). They can also take advantage of **spreadsheet**

#### Spreadsheet function

A computation provided by the spreadsheet software that can be incorporated into formulas

**functions** that are built into the software. In the tutor example, the formula in cell C9 uses the SUM function to compute the sum of the values in the cells C4, C5, C6, C7, and C8.

Because functions often operate on a set of contiguous cells, spreadsheets provide a convenient way to specify a **range** of cells. Syntactically, a range is specified with two dots (periods) between the two cell endpoints. A range can specify a set of cells along a row, such as C4..E4, or it can specify a set of cells down a column, such as C4..C8. A range can also specify a rectangular block of cells, ranging from the top left to the bottom right. For example, the range C4..E8 includes the cells C4 to C8, D4 to D8, and E4 to E8.

Several of the formulas shown in Figure 12.3 use the COUNT function, which computes the number of nonblank cells in the specified range. For example, the formula in cell G7 divides the value in cell F7 by the count of cells in the range C7..E7, which is 3.

The formula in cell G7 could have been written as follows:

```
=SUM(C7..E7)/3
```

Given the current status of the spreadsheet, this formula would compute the same result. However, this formula is not as good as the original, for two reasons. First, the sum of the values in C7 to E7 has already been computed (and stored in F7), so there is no need to recompute it. Any change to the data would affect the value of F7, and consequently change the value of G7 as well. Spreadsheets take all such relationships into account.

Second (and far more important), it is always a good idea to avoid using a constant in a formula unless it is specifically appropriate. In this case, using the value 3 as the predetermined number of tutors limits our ability to easily add or delete tutors from our analysis. Spreadsheet formulas respond to insertions and deletions just as they do to changes in raw data itself. If we insert a column for another tutor, the ranges in the original formulas in columns F and G (which would move to columns G and H due to the insertion) would automatically change to reflect the insertion. For example, if a new tutor column is inserted, the formula in cell F4 would be shifted to cell G4 and would now be

```
=SUM(C4..F4)
```

That is, the range of cells would increase to include the newly inserted data. Likewise, the ranges used by the COUNT function in other functions would change, resulting in a new—and correct—average. If we had used the constant 3 in the formula of cell G7, the calculation would be incorrect after the new column was inserted.

**Range** A set of contiguous cells specified by the endpoints

#### Another player in elder care

Lively is a product featuring sensors that can give feedback to children about an elderly parent who is living alone. For example, did the parent get something out of the refrigerator? Open the front door? Open a bottle of prescribed medicine? With the number of Americans age 65 or older projected to grow from 40 million in 2010 to 72 million in 2030, the need for such monitoring is bound to increase as well.<sup>1</sup>

| Function                               | Computes                                                                          |
|----------------------------------------|-----------------------------------------------------------------------------------|
| SUM(val1, val2, ...)<br>SUM(range)     | Sum of the specified set of values                                                |
| COUNT(val1, val2, ...)<br>COUNT(range) | Count of the number of cells that contain values                                  |
| MAX(val1, val2, ...)<br>MAX(range)     | Largest value from the specified set of values                                    |
| SIN(angle)                             | The sine of the specified angle                                                   |
| PI()                                   | The value of pi                                                                   |
| STDEV(val1, val2, ...)<br>STDEV(range) | The standard deviation from the specified sample values                           |
| TODAY()                                | Today's date                                                                      |
| LEFT(text, num_chars)                  | The leftmost characters from the specified text                                   |
| IF(test, true_val, false_val)          | If the test is true, it returns the true_val; otherwise, it returns the false_val |
| ISBLANK (value)                        | Returns true if the specified value refers to an empty cell                       |

**FIGURE 12.4** Some common spreadsheet functions

Usually a spreadsheet program provides a large number of functions that we can use in formulas. Some perform math or statistical calculations, common financial calculations, or special operations on text or dates. Others allow the user to set up logical relationships among cells. Examples of some common spreadsheet functions appear in [FIGURE 12.4](#). A typical spreadsheet program provides dozens of functions that the user may incorporate into formulas.

Another dynamic aspect of spreadsheets is the ability to copy values or formulas across a row or down a column. When formulas are copied, the relationships among cells are maintained. As a result, it becomes easy to set up a whole set of similar calculations. For instance, to enter the total calculations in our tutor example down the column from cell F4 to cell F8, we simply had to enter the formula in cell F4, and then copy that formula down the column. As the formula is copied, the references to the cells are automatically updated to reflect the row that the new formula is in. For our small example that tracks five weeks, the copy ability didn't save that much effort. But imagine we were tracking this data for a whole year and had 52 summation formulas to create. The copy aspect of spreadsheets makes setting up that entire column a single operation.



© Artur Debat/Getty Images; © Alan Dyer/Stocktrek Images/Getty Images

## Daniel Bricklin

Many of the people whose biographies appear in this book have been winners of the ACM Turing Award, the highest award given in computer science. The ACM also gives an award for outstanding work done by someone younger than age 35, called the Grace Murray Hopper Award. The charge for this award reads:

Awarded to the outstanding young computer professional of the year . . . selected on the basis of a single recent major technical or service contribution. . . . The candidate must have been 35 years of age or less at the time the qualifying contribution was made.

Daniel Bricklin won the Hopper Award in 1981, with the following citation:

For his contributions to personal computing and, in particular, to the design of VisiCalc. Bricklin's efforts in the development of the "Visual Calculator" provide the excellence and elegance that ACM seeks to sustain through such activities as the Awards program.

Daniel Bricklin, born in 1951, is a member of the computer generation. He began his college career at the Massachusetts Institute of Technology in 1969 as a math major, but quickly changed to computer science. He worked in MIT's Laboratory for Computer Science, where he worked on interactive systems and met his future business partner, Bob Franksten. After graduation, he was employed by Digital Equipment Corporation, where he worked with computerized typesetting and

helped to design the WPS-8 word processing product.

Bricklin enrolled in the MBA program at the Harvard Business School in 1977. While there, he began to envision a program that could manipulate numbers much in the same way that word processors manipulate text. As Bricklin realized, such a program would have an immense impact on the business world. He teamed up with his MIT buddy Franksten and turned the dream into a reality. With Bricklin doing the design and Franksten doing the programming, the pair created VisiCalc, the first spreadsheet program. In 1978, they formed Software Arts to produce and market VisiCalc. In the fall of 1979, a version was made available for the Apple II for \$100 per copy. A version for the IBM PC became available in 1981.

Bricklin made the decision not to patent VisiCalc, believing that software should not be proprietary. Although it didn't own a patent on its product, the company grew to 125 employees in four years. Soon, however, another start-up named Lotus came out with a spreadsheet package called Lotus 1-2-3, which was both more powerful and more user-friendly than VisiCalc. Software Arts' sales suffered. After a long, expensive court battle between Software Arts and VisiCorp (the company marketing VisiCalc), Bricklin was forced to sell to Lotus Software. In turn, Lotus 1-2-3 was surpassed by Microsoft's Excel spreadsheet program. Both Lotus 1-2-3 and Excel were based on VisiCalc.

Courtesy of Louis Fabian Bachrach/Dan Bricklin





© Artur Debat/Getty Images; © Alan Dyer/Stocktrek Images/Getty Images

## Daniel Bricklin (continued)

After working for a short time as a consultant with Lotus Software, Bricklin again formed a new company. As president of Software Garden, he developed a program for prototyping and simulating other pieces of software, which won the 1986 Software Publishers Association Award for “Best Programming Tool.” In 1990, he cofounded Slate Corporation to develop applications software for pen computers—that is, small computers that use a pen rather than a keyboard for input. After four years, Slate closed its doors, and Bricklin went back to Software Garden.

In 1995, Bricklin founded Trellix Corporation, a leading provider of private-label website publishing technology. Trellix was acquired by Interland, Inc., in 2003. In early 2004, Bricklin

returned to Software Garden as president. In 2013, he joined Alpha Software as their chief technical officer.

When Bricklin was asked to share his view of the Internet, this was his reply: “Most people don’t understand it. They fail to grasp the capabilities of its underpinnings.” He likens the Net to a primitive road during the early days of the automobile, when few saw the potential that a massive interstate highway system might one day provide. “We need to understand not so much the technology,” he explains, “but the progression of technology and what might be built with it. E-commerce, like electricity or the telephone, simply enables us to use technology to do what we now do, only better.”

### Circular reference

A set of formulas that ultimately, and erroneously, rely on each other to compute their results

| Cell | Contents           |
|------|--------------------|
| A1   | =B7*COUNT(F8..k8)  |
| B7   | =A14+SUM(E40..E50) |
| E45  | =G18+G19–D13       |
| D13  | =D12/A1            |

**FIGURE 12.5** A circular reference situation that cannot be resolved

## Circular References

Spreadsheet formulas could be defined such that they create a **circular reference**—that is, a reference that can never be resolved because the result of one formula is ultimately based on another, and vice versa. For instance, if cell B15 contains the formula

=D22+D23

and cell D22 contains the formula

=B15+B16

there is a circular reference. Cell B15 uses the value in cell D22 for its result, but cell D22 relies on B15 for its result.

Circular references are not usually this blatant and may involve many cells. A more complicated situation is presented in **FIGURE 12.5**. Ultimately, cell A1 relies on cell D13 for its value, and vice versa. Spreadsheet software usually detects such a problem and indicates the error.

## Spreadsheet Analysis

One reason why spreadsheets are so useful is their versatility. The user of a spreadsheet determines what the data represents and how it is related to other data. Therefore, spreadsheet analysis can be applied to just about any topic area. We might, for instance, use a spreadsheet to perform the following tasks:

- Track sales
- Analyze sport statistics
- Maintain student grades
- Keep a car maintenance log
- Record and summarize travel expenses
- Track project activities and schedules
- Plan stock purchases

The list of potential applications is virtually endless. Business, in general, has a huge number of specific situations in which spreadsheet calculations are essential. It makes you wonder how we got along without them.

Their dynamic nature also makes spreadsheets highly useful. If we set up the spreadsheet formulas correctly, then our changes, additions, and deletions to the data are automatically taken into account by the appropriate calculations.

The dynamic nature of spreadsheets also provides the powerful ability to carry out **what-if analysis**. We can set up spreadsheets that take into account certain assumptions, and then challenge those assumptions by changing the appropriate values.

As an example, suppose we are setting up a spreadsheet to estimate the costs and potential profits for a seminar we are considering holding. We can enter values for the number of attendees, ticket prices, cost of materials, room rental, and other data that affects the final results. Then we can ask ourselves some what-if questions to see how our scenario changes as the situation changes:

What if the number of attendees decreased by 10%?

What if we increased the ticket price by \$5?

What if we could reduce the cost of materials by half?

As we ask these questions, we change the data accordingly. If we've set up the relationships among all of the formulas correctly, then each change immediately shows us how it affects the other data.

### What-if analysis

Modifying spreadsheet values that represent assumptions to see how changes in those assumptions affect related data

## Chapter 12: Information Systems

Business analysts have formalized this process in various ways, and spreadsheets have become an essential tool in their daily work. Cost-benefit analysis, break-even calculations, and projected sales estimates all become a matter of organizing the spreadsheet data and formulas to take the appropriate relationships into account.

### Spreadsheet Visualizations

They say a picture is worth a thousand words. Well, that's true about numbers, too. Reading raw data is often hard, and rarely provides the insight that a good visual representation of the data can. The goal of data analysis is to provide insight into the data that can be communicated to others.

Modern spreadsheet applications usually provide a mechanism for displaying the data in the spreadsheet in various types of graphs, such as line charts or pie charts. In fact, the number of graph types is often quite extensive, and allows you to tailor exactly how best to convey the ideas you want to emphasize. An example of a graph generated by Microsoft Excel is shown in [FIGURE 12.6](#).

As with “what if” analysis, as the data changes, the generated graphs can change to reflect the modifications.

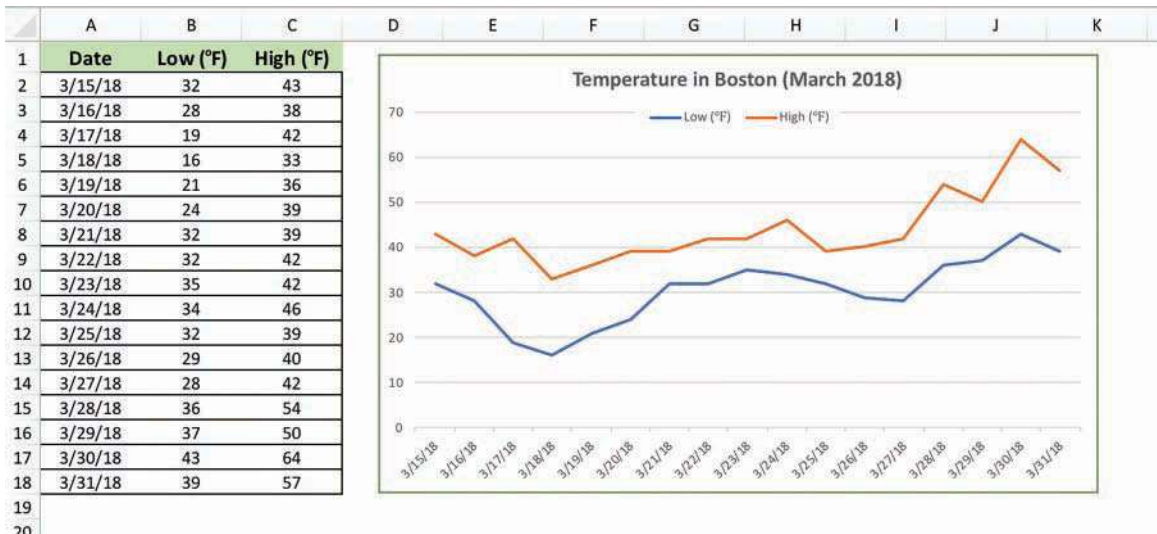


FIGURE 12.6 A graph generated using spreadsheet data

## 12.3 Database Management Systems

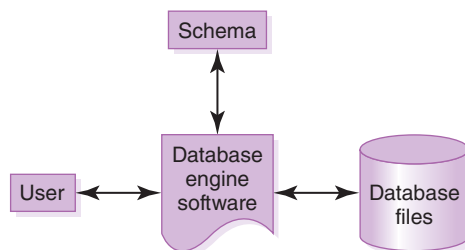
Almost all sophisticated data management situations rely on an underlying database and the support structure that allows the user (either a human or a program) to interact with it. A **database** can simply be defined as a structured set of data. A **database management system** (DBMS) is a combination of software and data made up of three components:

- The physical database—a collection of files that contain the data
- The database engine—software that supports access to and modification of the database contents
- The database schema—a specification of the logical structure of the data stored in the database

The database engine software interacts with specialized database languages that allow the user to specify the structure of data; add, modify, and delete data; and **query** the database to retrieve specific stored data.

The database **schema** provides the logical view of the data in the database, independent of how it is physically stored. Assuming that the underlying physical structure of the database is implemented in an efficient way, the logical schema is the more important point of view from the database user's perspective because it shows how the data items relate to each other.

**FIGURE 12.7** depicts the relationships among the various elements of a database management system. The user interacts with the database engine software to determine and/or modify the schema for the database. The user then interacts with the engine software to access and possibly modify the contents of the database stored on disk.



**FIGURE 12.7** The elements of a database management system

**Database** A structured set of data

**Database management system** A combination of software and data made up of the physical database, the database engine, and the database schema

**Query** A request to retrieve data from a database

**Schema** A specification of the logical structure of data in a database

**Relational model** A database model in which data and the relationships among them are organized into tables

**Table** A collection of database records

**Record (or object, or entity)** A collection of related fields that make up a single database entry

**Field (or attribute)** A single value in a database record

**Key** One or more fields of a database record that uniquely identifies it among all other records in the table

relational DBMS, the data items and the relationships among them are organized into **tables**. A table is a collection of **records**. A record is a collection of related **fields**. Each field of a database table contains a single data value. Each record in a table contains the same fields.

A record in a database table is also called a *database object* or an *entity*. The fields of a record are sometimes called the *attributes* of a database object.

As an example, consider the database table shown in [FIGURE 12.8](#), which contains information about movies. Each row in the table corresponds to a record. Each record in the table is made up of the same fields in which particular values are stored. That is, each movie record has a *MovieId*, a *Title*, a *Genre*, and a *Rating* that contains the specific data for each record. A database table is given a name, such as *Movie* in this case.

Usually, one or more fields of a table are identified as **key** fields. The key field(s) uniquely identifies a record among all other records in the table. That is, the value stored in the key field(s) for each record in a table must be unique. In the *Movie* table, the *MovieId* field would be the logical choice for a key. That way, two movies could have the same title. Certainly the *Genre* and *Rating* fields are not appropriate key fields in this case.

Each value in the key field *MovieId* must be unique. Most DBMSs allow such fields to be automatically generated to guarantee unique entries. The key values do not have to be consecutive, however. The last three entries of

| MovieId | Title              | Genre            | Rating |
|---------|--------------------|------------------|--------|
| 101     | Sixth Sense, The   | thriller horror  | PG-13  |
| 102     | Back to the Future | comedy adventure | PG     |
| 103     | Monsters, Inc.     | animation comedy | G      |
| 104     | Field of Dreams    | fantasy drama    | PG     |
| 105     | Alien              | sci-fi horror    | R      |
| 106     | Unbreakable        | thriller         | PG-13  |
| 107     | X-Men              | action sci-fi    | PG-13  |
| 5022    | Elizabeth          | drama period     | R      |
| 5793    | Independence Day   | action sci-fi    | PG-13  |
| 7442    | Platoon            | action drama war | R      |

**FIGURE 12.8** The *Movie* database table, made up of records and fields

the table contain radically different movie identification numbers. As long as they are unique values, the *MovieId* field can serve as the key.

The *Movie* table in Figure 12.8 happens to be presented in the order of increasing *MovieId* value, but it could have been displayed in other ways, such as alphabetical by movie title. In this case, there is no inherent relationship among the rows of data in the table. Relational database tables present a logical view of the data and have nothing to do with the underlying physical organization (how the records are stored on disk). Ordering records becomes important only when we query the database for particular values, such as all movies that are rated PG. At that point we might want to sort the results of the query by title.

The structure of the table corresponds to the schema it represents. That is, a schema is an expression of the attributes of the records in a table. We can express the schema for this part of the database as follows:

*Movie* (*MovieId*:key, *Title*, *Genre*, *Rating*)

Sometimes a schema representation indicates the type of data that is stored in individual fields, such as numeric or text. It may also indicate the specific set of values that are appropriate for a given field. For instance, the schema could indicate in this example that the *Rating* field can be only G, PG, PG-13, R, or NC-17. The schema for an entire database is made up of the individual schema that corresponds to individual tables.

Suppose we wanted to create a movie rental business. In addition to the list of movies for rent, we must create a database table to hold information about our customers. The *Customer* table in [FIGURE 12.9](#) could represent this information.

Similar to what we did with our *Movie* table, the *Customer* table contains a *CustomerId* field to serve as a key. The fact that some *CustomerId*

| CustomerId | Name          | Address               | CreditCardNumber    |
|------------|---------------|-----------------------|---------------------|
| 101        | Dennis Cook   | 123 Main Street       | 2736 2371 2344 0382 |
| 102        | Doug Nickle   | 456 Second Ave        | 7362 7486 5957 3638 |
| 103        | Randy Wolf    | 789 Elm Street        | 4253 4773 6252 4436 |
| 104        | Amy Stevens   | 321 Yellow Brick Road | 9876 5432 1234 5678 |
| 105        | Robert Person | 654 Lois Lane         | 1122 3344 5566 7788 |
| 106        | David Coggin  | 987 Broadway          | 8473 9687 4847 3784 |
| 107        | Susan Klaton  | 345 Easy Street       | 2435 4332 1567 3232 |

**FIGURE 12.9** The *Customer* database table, containing customer data

### Won't they ever stop?

?

Here's another example of a scam conducted by email: "I am Mr. Cham Tao Soon, Chairman Audit Committee of UOB Bank, Singapore. I have a project for you in the tons of One Hundred & Five Million EUR, after successful transfer, we shall share in the ratio of forty for you and sixty for me. Please reply for specifics." Beware of anything that sounds too good to be true!?"

© Artur Debat/Getty Images; © Alan Dyer/Stocktrek Images/Getty Images

## Universal Product Code

When you look on the packaging of most products, you will find a Universal Product Code (UPC) and its associated bar code, such as the one shown to the right. UPC codes were created to speed up the process of purchasing a product at a store and to help keep better track of inventory.

A UPC symbol is made up of the machine-readable bar code and the corresponding human-readable 12-digit UPC number. The first six digits of the UPC number are the *manufacturer identification number*. For example, General Mills has a manufacturer ID number of 016000. The next five digits are the *item number*. Each type of product, and each different packaging of the same product, is assigned a unique item number. For example, a 2-liter bottle of Coke has a different item number than a 2-liter bottle of Diet Coke, and a 10-ounce bottle of Heinz ketchup has a different item number than a 14-ounce bottle of Heinz ketchup.

The last digit of the UPC code is the *check digit*, which allows the scanner to determine whether it scanned the number correctly. After reading the number, a calculation is performed



A UPC symbol

on the rest of the digits of the number to determine the check digit. The result is then verified against the actual check digit. (See Chapter 18 for more information on check digits.)

For some products, particularly small ones, a technique has been developed to create UPC numbers that can be shortened by eliminating certain digits (all zeros). In this way, the entire UPC symbol can be reduced in size.

Note that a product's price is not stored in the UPC number. When a product is scanned at a cash register—more formally called a *point of sale* (POS)—the manufacturer and item numbers are used to look up that item in a database. The database might contain a great deal of product information, including its price. Keeping only basic information in the UPC number makes it easy to change other information, such as the price, without having to relabel the products. Unfortunately, this flexibility also makes it easy to create situations of “scanner fraud” in which the database price of an item does not match the price on the store shelf, whether intentionally or not.

values correspond to some *MovieId* values is irrelevant. Key values must be unique only within a table.

In a real database, we would be better off subdividing the *Name* field of our *Customer* table into *FirstName* and *LastName* fields. Also, we would probably use separate fields to hold various parts of a complete address, such as *City* and *State*. For our examples we are keeping things simple.

The *Movie* table and the *Customer* table show how data can be organized as records within isolated tables. The real power of relational



database management systems, though, lies in the ability to create tables that conceptually link various tables together, as discussed in the next section.

## Relationships

Recall that records represent individual database objects, and that fields of a record are the attributes of these objects. We can create a record to represent a relationship among objects and include attributes about the relationship in that record. In this way, we can use a table to represent a collection of relationships among objects.

Continuing our movie rental example, we need to be able to represent the situation in which a particular customer rents a particular movie. Because “rents” is a relationship between a customer and a movie, we can represent it as a record. The date rented and the date due are attributes of the relationship that should be in the record. The *Rents* table in [FIGURE 12.10](#) contains a collection of these relationship records that represents the movies that are currently rented.

The *Rents* table contains information about the objects in the relationship (customers and movies), as well as the attributes of the relationship. It does not hold all of the data about a customer or a movie, however. In a relational database, we avoid duplicating data as much as possible. For instance, there is no need to store the customer’s name and address in the rental table—that data is already stored in the *Customer* table. When we need that data, we use the *CustomerId* stored in the *Rents* table to look up the customer’s detailed data in the *Customer* table. Likewise, when we need data about the movie that was rented, we look it up in the *Movie* table using the *MovieId*.

Note that the *CustomerId* value 103 is shown in two records in the *Rents* table. Its two appearances indicate that the same customer rented two different movies.

Data is modified in, added to, and deleted from our various database tables as needed. When movies are added or removed from the available

| CustomerId | MovieId | DateRented | DateDue   |
|------------|---------|------------|-----------|
| 103        | 104     | 3-12-2018  | 3-13-2018 |
| 103        | 5022    | 3-12-2018  | 3-13-2018 |
| 105        | 107     | 3-12-2018  | 3-15-2018 |

**FIGURE 12.10** The *Rents* database table, storing current movie rentals



stock, we update the records of the *Movie* table. As people become new customers of our store, we add them to the *Customer* table. On an ongoing basis, we add and remove records from the *Rents* table as customers rent and return videos.

## Structured Query Language

### Structured Query Language (SQL)

A comprehensive relational database language for data management and queries

**Structured Query Language (SQL)** is a comprehensive database language for managing relational databases. It includes statements that specify database schemas as well as statements that add, modify, and delete database content. In addition, as its name implies, SQL provides the ability to query the database to retrieve specific data.

The original version of SQL was Sequel, developed by IBM in the early 1970s. In 1986, the American National Standards Institute (ANSI) published the SQL standard, which serves as the basis for commercial database languages for accessing relational databases.

SQL is not case sensitive, so keywords, table names, and attribute names can be uppercase, lowercase, or mixed case. Spaces are used as separators in a statement. Because this is a specific programming language, we use a monospaced code font.

## Queries

Let's first focus on simple queries. The *select* statement is the primary tool for this purpose. The basic *select* statement includes a *select* clause, a *from* clause, and a *where* clause:

```
select attribute-list from table-list where condition
```

The *select* clause determines which attributes are returned. The *from* clause determines which tables are used in the query. The *where* clause restricts the data that is returned. For example:

```
select Title from Movie where Rating = 'PG'
```

The result of this query is a list of all titles from the *Movie* table that have a PG rating. The *where* clause can be eliminated if no special restrictions are necessary:

```
select Name, Address from Customer
```

This query returns the name and address of all customers in the *Customer* table. An asterisk (\*) can be used in the *select* clause to denote that all attributes in the selected records should be returned:

```
select * from Movie where Genre like '%action%'
```

This query returns all attributes of records from the *Movie* table in which the *Genre* attribute contains the word “action.” The `like` operator in SQL performs some simple pattern matching on strings, and the `%` symbol matches any string.

*Select* statements can also dictate how the results of the query should be sorted using the `order by` clause:

```
select * from Movie where Rating = 'R' order by Title
```

This query returns all attributes of R-rated movies sorted by the movie title.

SQL supports many more variations of *select* statements than are shown here. Our goal is simply to introduce the database concepts—you would require much more detail to become truly proficient at SQL queries.

## Modifying Database Content

SQL's *insert*, *update*, and *delete* statements allow the data in a table to be changed. The *insert* statement adds a new record to a table. Each *insert* statement specifies the values of the attributes for the new record. For example:

```
insert into Customer values (9876, 'John Smith',
'602 Greenbriar Court', '2938 3212 3402 0299')
```

This statement inserts a new record into the *Customer* table with the specified attributes.

The *update* statement changes the values in one or more records of a table. For example:

```
update Movie set Genre = 'thriller drama' where title =
'Unbreakable'
```

This statement changes the *Genre* attribute of the movie *Unbreakable* to “thriller drama.”

The *delete* statement removes all records from a table matching the specified condition. For example, if we wanted to remove all R-rated movies from the *Movie* table, we could use the following *delete* statement:

```
delete from Movie where Rating = 'R'
```

As with the *select* statement, there are many variations of the *insert*, *update*, and *delete* statements.

## Database Design

A database must be carefully designed from the outset if it hopes to fulfill its role. Poor planning in the early stages can lead to a database that does not support the required relationships.

### Mathematical basis of SQL

?

SQL incorporates operations in an algebra that is defined for accessing and manipulating data represented in relational tables. E. F. Codd of IBM defined this algebra and he won the Turing Award for his work. SQL's fundamental operations include these:

- *Select* operation, to identify records in a table
- *Project* operation, to produce a subset of the columns in a table
- *Cartesian product* operation, to concatenate rows from two tables

Other operations include the set operations *union*, *difference*, *intersection*, *natural join* (a subset of Cartesian product), and *division*.

**Entity-relationship (ER) modeling**

A popular technique for designing relational databases

**ER diagram**

A graphical representation of an ER model

**Cardinality constraint**

The number of relationships that may exist at one time among entities in an ER diagram

One popular technique for designing relational databases is called **entity-relationship (ER) modeling**. Chief among the tools used for ER modeling is the ER diagram. An **ER diagram** captures the important record types, attributes, and relationships in a graphical form. From an ER diagram, a database manager can define the necessary schema and create the appropriate tables to support the database specified by the diagram.

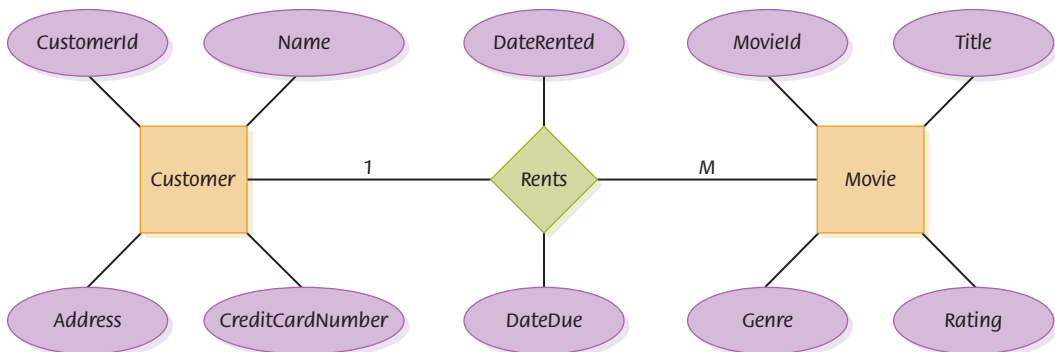
**FIGURE 12.11** presents an ER diagram showing various aspects of the movie rental example. Specific shapes are used in ER diagrams to differentiate among the various parts of the database. Types of records (which can also be thought of as classes for the database objects) are shown in rectangles. Fields (or attributes) of those records are shown in attached ovals. Relationships are shown in diamonds.

The positions of the various elements of an ER diagram are not particularly important, though giving some thought to them will make the diagram easier to read. Note that a relationship such as *Rents* can have its own associated attributes.

Also note that the relationship connectors are labeled, one side with a 1 and the other side with an M. These designations show the **cardinality constraint** of the relationship. A cardinality constraint puts restrictions on the number of relationships that may exist at one time. Three general cardinality relationships are possible:

- One-to-one
- One-to-many
- Many-to-many

The relationship between a customer and a movie is one-to-many. That is, one customer is allowed to rent many movies, but a movie can be rented by only a single customer (at any given time). Cardinality constraints help the database designer convey the details of a relationship.



**FIGURE 12.11** An ER diagram for the movie rental database

## 12.4 E-Commerce

Computer applications in the realm of **electronic commerce**, or e-commerce, deal with financial transactions made through the Web. It includes all aspects of the marketing, sales, and buying of both products and services as well as other financial services such as banking transactions. These days, the Web is often the first option for people considering a purchase.

When the Web burst into public view in 1994, many people predicted that it would have a large impact on the way we do business. In fact, it took several years for e-commerce to begin to be trusted enough, and become functional enough, to take root in our culture. The dot-com collapse of 2001, instead of diminishing e-commerce, seemed to promote it by clearing the way for organizations with legitimate business models to make a place for themselves online. During this period, in addition to new, purely online businesses cropping up, traditional “brick-and-mortar” businesses developed a significant online presence.

Amazon.com, one of the oldest e-commerce sites on the Web, did not make a profit for many years. But by persevering through (sometimes painful) growth spurts, it emerged as a premiere e-commerce destination for shoppers. eBay, a popular auction site, allowed anyone to sell their products online, even without an underlying formal business; today, many retailers conduct their transactions purely through the eBay environment. Companies such as PayPal, which make the process of online purchases much easier by abstracting the buyer’s financial details, were also key to e-commerce success. In fact, eBay purchased PayPal in 2002; like many online sites, eBay uses PayPal exclusively as its electronic payment system.

The evolution of web-based technologies was a major factor in the success of e-commerce and the driving force behind some of it. The ability for an online application to provide enhanced user interaction was critical in this growth, as was the development of secure protocols and other factors that permit the secure transfer of electronic funds.

Electronic shopping carts are a key part of the e-commerce process, allowing users to maintain an ongoing collection of items and purchase those items in a single transaction. Many e-commerce sites track a user’s purchases and make suggestions for other items that a user might find interesting. This is an aspect of e-commerce that is not easily replicated with traditional store purchases.

Another important aspect to the success of e-commerce is the evolution of sellers’ understanding of how shoppers shop. That is, the best e-commerce sites now have facilities that allow a user to search for and compare items in various ways. Again, these functional aspects often surpass the user’s experience when visiting a physical store.

### Electronic commerce

The process of buying and selling products and services using the World Wide Web

### Secondhand shopping

?

Websites such as eBay and Craigslist make it easy for people to sell unwanted goods. Some experts predict that the secondary auction industry may eventually change the way people think about what they buy. As it becomes easier to resell items, people may take this factor into consideration when purchasing an item. This trend could lead to temporary ownership of increasingly more goods, with people effectively “leasing” things rather than buying items and later discarding them.

One of the biggest challenges that remains for e-commerce is the need to ensure security in the financial transactions inherent in the process. Many people still have strong misgivings about conducting business online, but trust in online transactions has grown rapidly. Indeed, the need for computer security is greater than ever.

## 12.5 Big Data

The information systems discussed in this chapter can deal with a lot of data, but the digital age has changed the playing field in many ways. We generate data with almost every action we take. When we buy something online, when we post on social media, when we carry our phones with GPS tracking capabilities, we leave a digital trail. Experts suggest that *every two days*, human beings collectively generate as much data as we did from the beginning of time until the year 2000.

This situation has given rise to the term **big data**, which refers to data sets that are so large and complex that information systems we've discussed so far such as spreadsheets and databases are inadequate to deal with them. The specifics of big data techniques are beyond the scope of this book, but it's crucial to understand big data's growing importance.

Big data can lead to big insight. The more you know about something, the better you can manage and guide it as desired. Big data techniques allow us to compare more data, revealing relationships that were previously hidden.

The benefits of big data are numerous to commercial businesses. The additional insights can reveal what customers want to buy, and when, and can help companies run more efficiently. In the future, businesses that adopt a data-driven outlook and view data as a strategic asset will have a distinct advantage over those that don't.

Big data is also having a big impact beyond traditional business models. Healthcare organizations are using big data solutions to analyze vast numbers of medical records and images, which helps diagnose diseases and develop new medicines. Huge amounts of sensor data are being used to predict and respond to natural disasters. Police forces are using both public and private data sets to predict and prevent crime.

But that new insight comes at a price. There are many challenges when it comes to big data:

- Large data sets often contain different kinds of data—not just basic numeric data, text, and images, but also multimedia elements such as audio, video, and animations.
- Storing large amounts of data requires massive amounts of secondary memory.

**Big data** Large data sets that defy conventional management solutions such as spreadsheets and databases.

- Selecting and organizing that data so it can be analyzed and turned into meaningful information requires significant processing power.
- Protecting big data, which often contain sensitive personal information, requires careful technological and logistical planning.

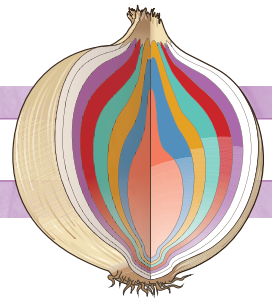
An information system that is set up to handle big data must be able to scale quickly and adequately; that is, as new data arrives, the techniques used by the information system must be able to handle the load. If an information system cannot scale sufficiently, it will restrict how the data can be used, if not grind to a halt.

Therefore, the ability to handle big data requires careful planning and specific computational solutions. It often involves an automated process that creates simulations based on the data and rerunning those simulations until patterns emerge.

It is likely that spreadsheets and databases will always play an important role in computing. Not all problems require a big data solution. However, it is crucial to understand the ever-increasing role that big data plays in the future of computing.

© Artur Debat/Getty Images, © Alan Dyer/Stocktrek Images/Getty Images

## SUMMARY



An information system is application software that allows the user to organize and manage data. General information system software includes spreadsheets and database management systems. Other domain areas, such as artificial intelligence, have their own specific techniques and support for data management.

A spreadsheet is a software application that sets up a grid of cells to organize data and the formulas used to compute new values. Cells are referenced by their row and column designations, such as A5 or B7. Formulas usually refer to the values in other cells and may rely on built-in functions to compute their result. In addition, formulas may use data across a range of cells. When a formula is stored in a spreadsheet cell, the value computed by the formula is actually shown in the cell. It is important that formulas in a spreadsheet avoid circular references, in which two or more cells rely on one another to compute their results.

Spreadsheets are both versatile and extensible. They can be used in many different situations, and they respond dynamically to change. As values in the spreadsheet change, affected formulas are automatically recalculated to produce updated results. If spreadsheet rows or columns are added, the ranges in spreadsheet formulas are adjusted immediately.

Spreadsheets are particularly appropriate for what-if analysis, in which assumptions are modified to see their effect on the rest of the system.

A database management system includes the physical files in which the data are stored, the software that supports access to and modification of that data, and the database schema that specifies the logical layout of the database. The relational model is the most popular database approach today. It is based on organizing data into tables of records (or objects) with particular fields (or attributes). A key field, whose value uniquely identifies individual records in the table, is usually designated for each table.

Relationships among database elements are represented in new tables that may have their own attributes. Relationship tables do not duplicate data in other tables. Instead, they store the key values of the appropriate database records so that the detailed data can be looked up when needed.

Structured Query Language (SQL) is the language used for querying and manipulating relational databases. The *select* statement is used to formulate queries and has many variations so that particular data can be accessed from the database. Other SQL statements allow data to be added, updated, and deleted from a database.

A database should be carefully designed. Entity-relationship modeling, with its associated ER diagrams, is a popular technique for database design. ER diagrams graphically depict the relationships among database objects and show their attributes and cardinality constraints.

E-commerce is the process of buying and selling services over the Internet. As e-commerce has become increasingly more popular, more stringent security measures have had to be employed to ensure the integrity of sales over the Internet.

*Big data* is the term used to describe the management of large sets of data that defy traditional solutions such as spreadsheets and database management systems. The insights that big data techniques can yield are important, but require us to overcome the challenges of storing, managing, and analyzing more data than human beings have ever had to deal with before.





## ETHICAL ISSUES

### Politics and the Internet

The Internet has changed the way political campaigns are run. Just looking at the last few presidential campaigns shows the incredible impact the use of network resources has had, affecting campaign finances, politicians' behavior, and voter opinions.

A single-day record for raising campaign contributions was set by Ron Paul (Republican), who collected \$6 million in one day in 2007 through Internet donations. More notable was Howard Dean (Democrat), who used the Internet as a fundamental tool in his "50-state strategy" primary run in 2004. Although Dean was ultimately defeated in the election, none could deny his success at raising funds through his pioneering Internet campaign of a "\$100 revolution," in which 2 million Americans would give \$100 to Dean's campaign so he could compete with the Republican candidate, George W. Bush. In 2008, Barack Obama, taking a lead from Dean's emphasis on small donors and the Internet, raised almost half of his \$639 million in campaign funds from 3 million donors who gave \$300 or less. Understanding that a successful campaign is run on its cash flow, Obama's staff directed much of its social networking and Internet time toward raising campaign funds.

In the 2008 campaign, the websites of both candidates became the primary focal points where their supporters campaigned for them and undecided voters went to get information. Both campaigns used social

media as never before, and relied on thousands of personal blogging sites and forums to get their message out. The Internet allows candidates to quickly respond to negative feedback by quickly adding or editing text and video.

In 2012, it was generally agreed that Obama won the election through his team's use of data mining the Internet. To quote *Time*, "Data-driven decisionmaking played a huge role in creating a second term for the 44th president and will be one of the more closely studied elements in the 2012 cycle." For the 2012 race, Obama's campaign manager, Jim Messina, promised a metric-driven kind of campaign. The campaign's analytics department was five times larger than that of the 2008 campaign. For two years they collected, stored, and analyzed data. This data collection and mining effort helped Obama raise \$1 billion, created detailed models of swing-state voters, and updated the process of targeting TV ads.<sup>3</sup>

The 2016 national election saw the Internet affect presidential politics in new and sometimes disturbing ways. Not only was fundraising and information sharing through the Internet at its peak, but messages delivered by a politician to the electorate took an interesting turn. Politicians have always found ways to denigrate their opponents, but Donald Trump did so using social media in ways never seen before.

During the Republican primary process, Donald Trump used Twitter to call his





## ETHICAL ISSUES

### Politics and the Internet (CONTINUED)

opponents names. Marco Rubio was “Little Marco,” Ted Cruz was “Lyin’ Ted,” and Jeb Bush was “Low-Energy Jeb.” As it became increasingly clear that Trump would win the primary, he turned his sights on the Democrats, calling Hillary Clinton “Crooked Hillary” and Bernie Sanders “Crazy Bernie.”

Trump’s use of social media shocked many, who saw it as unpresidential and compared it to cyberbullying. His supporters, however, reveled in it, saying they liked how Trump “tells it like it is.” Many people assumed that Trump would eventually soften his rhetoric, but that didn’t happen. After he won the presidential election, he continued to use Twitter on a daily basis, bashing those who opposed him or his positions.

During his presidency, Trump’s staff was sometimes surprised to learn of a policy decision via a tweet, causing them to scramble. In 2018, then-Secretary of State Rex Tillerson found out he was being fired only when Trump tweeted about it.<sup>4</sup>

Donald Trump’s use of Twitter continues to have a significant impact on day-to-day activities in the U.S. government, and the debate continues as to whether the effects are positive or negative.

Other countries are also able to affect our elections using social media. U.S. intelligence agencies agree that the Russian government interfered in the 2016 presidential election to damage Hillary Clinton’s campaign and bolster the candidacies of her opponents.

Among other activities, the Russian government actively disseminated fake news through social media outlets such as Facebook using accounts created specifically for that purpose and with online advertisements (paid for using Russian rubles).<sup>5</sup>

At the time of this writing, an investigation led by special prosecutor Robert Mueller is ongoing, examining the Russian interference and exploring any links or coordination between Donald Trump’s campaign and the Russian government.

## KEY TERMS

|                                   |                                 |
|-----------------------------------|---------------------------------|
| Big data                          | Key (database)                  |
| Cardinality constraint            | Query                           |
| Cell                              | Range                           |
| Circular reference                | Record (or object, or entity)   |
| Database                          | Relational model                |
| Database management system        | Schema                          |
| Electronic commerce               | Spreadsheet                     |
| Entity-relationship (ER) modeling | Spreadsheet function            |
| ER diagram                        | Structured Query Language (SQL) |
| Field (or attribute)              | Table                           |
| Information system                | What-if analysis                |

## EXERCISES

For Exercises 1–20, mark the answers true or false as follows:

- A. True
  - B. False
1. A cell in a spreadsheet can contain only raw data.
  2. The values in a spreadsheet can be formatted in a variety of ways.
  3. A spreadsheet should be set up so that changes to the data are automatically reflected in any cells affected by that data.
  4. A spreadsheet function is a program that the user writes to compute a value.
  5. A range of cells can be specified that go horizontally or vertically, but not both.
  6. A circular reference in a spreadsheet is a powerful and useful tool.
  7. A spreadsheet is useful for performing what-if analysis.
  8. What-if analysis can affect only one value at a time in a spreadsheet.
  9. A database engine is software that supports access to the database contents.
  10. The physical database represents the logical structure of the data in the database.
  11. A query is a request to a database for information.
  12. The results of a query can be structured in many ways.
  13. The hierarchical model is the most popular database management model today.
  14. A database table is a collection of records, and a record is a collection of fields.

## EXERCISES (CONTINUED)

15. The values in the key fields of a table uniquely identify a record among all other records in the table.
16. A database engine often interacts with a particular language for accessing and modifying the database.
17. An entity-relationship (ER) diagram represents primary database elements in a graphical form.
18. The cardinality of a relationship puts restrictions on the number of relationships that can exist at one time.
19. E-commerce is the process of keeping financial records, such as accounts payable, online.
20. The dot-com collapse promoted electronic commerce.

For Exercises 21–25, match the solution to the question.

- A. dynamic    D. range  
 B. function    E. schema  
 C. circular    F. field

21. A spreadsheet is \_\_\_\_ in that it responds to changes in the data by immediately updating all affected values.
22. A spreadsheet formula may operate on a \_\_\_\_ of cells, such as C4..C18.
23. The database \_\_\_\_ is the specification of the logical structure of the data in the database.
24. A \_\_\_\_ reference occurs when the result of one formula is ultimately based on another, and vice versa.
25. A \_\_\_\_ contains a single data value.

Exercises 26–38 are problems or short-answer questions.

Use the following spreadsheet containing student grades for Exercises 26–34.

|    | A | B        | C     | D       | E       | F       | G       | H |
|----|---|----------|-------|---------|---------|---------|---------|---|
| 1  |   |          |       |         | Grades  |         |         |   |
| 2  |   |          |       | Exam 1  | Exam 2  | Exam 3  | Average |   |
| 3  |   |          |       |         |         |         |         |   |
| 4  |   |          | Bill  | 89      | 33      | 80      | 67.3333 |   |
| 5  |   |          | Bob   | 90      | 50      | 75      | 71.6666 |   |
| 6  |   |          | Chris | 66      | 60      | 70      | 65.3333 |   |
| 7  |   |          | Jim   | 50      | 75      | 77      | 67.3333 |   |
| 8  |   | Students | Judy  | 80      | 80      | 80      | 80      |   |
| 9  |   |          | June  | 83      | 84      | 85      | 84      |   |
| 10 |   |          | Mari  | 87      | 89      | 90      | 88.6666 |   |
| 11 |   |          | Mary  | 99      | 98      | 90      | 95.6666 |   |
| 12 |   |          | Phil  | 89      | 90      | 85      | 88      |   |
| 13 |   |          | Sarah | 75      | 90      | 85      | 83.3333 |   |
| 14 |   |          | Suzy  | 86      | 90      | 95      | 90      |   |
| 15 |   | Total    |       | 893     | 839     | 912     | 881.333 |   |
| 16 |   | Average  |       | 81.1818 | 76.2727 | 82.9090 | 80.1212 |   |

21. A spreadsheet is \_\_\_\_ in that it responds to changes in the data by immediately updating all affected values.
22. A spreadsheet formula may operate on a \_\_\_\_ of cells, such as C4..C18.
23. The database \_\_\_\_ is the specification of the logical structure of the data in the database.
24. A \_\_\_\_ reference occurs when the result of one formula is ultimately based on another, and vice versa.
25. A \_\_\_\_ contains a single data value.
26. Specify the grades for Exam 2.
27. Specify the average for Exam 1.
28. Specify the average for Sarah.
29. Specify the third exam grade for Mari.
30. Specify the exam grades for Suzy.
31. What formula is stored in F15?
32. D16 contains the formula D15/COUNT(D4..D14). What is another

**EXERCISES (CONTINUED)**

formula that would yield the same value?

33. What formula is stored in E13?
34. Which values would change if Phil's Exam 2 score was corrected to 87?
35. What is a spreadsheet circular reference? Why is it a problem?
36. Give a specific example of an indirect circular reference similar to the one shown in Figure 12.5.
37. What is what-if analysis?
38. Name some what-if analysis questions that you might ask if you were using a spreadsheet to plan and track some stock purchases. Explain how you might set up a spreadsheet to help answer those questions.

For Exercises 39–42, use the paper spreadsheet form supplied on the textbook's website or use an actual spreadsheet application program to design the spreadsheets. Your instructor may provide more specific instructions regarding these questions.

39. Design a spreadsheet to track the statistics of your favorite major league baseball team. Include data regarding runs, hits, errors, and runs batted in (RBIs). Compute appropriate statistics for individual players and the team as a whole.
40. Design a spreadsheet to maintain a grade sheet for a set of students. Include tests and projects, giving various weights to each in the calculation of the final grade for each student. Compute the average grade per test and project for the whole class.
41. Assume you are going on a business trip. Design a spreadsheet to keep track of your expenses and create a summary of your totals. Include various aspects of travel such as car mileage, flight costs, hotel costs, and miscellaneous expenses (such as taxis and tips).
42. Design a spreadsheet to estimate and then keep track of a particular project's activities. List the activities, the estimated and actual dates for those activities, and schedule slippage or gain. Add other data as appropriate for your project.
43. Compare a database with a database management system.
44. What is a database schema?
45. Describe the general organization of a relational database.
46. What is a field (attribute) in a database?
47. Which other fields (attributes) might we include in the database table of Figure 12.8?
48. Which other fields (attributes) might we include in the database table of Figure 12.9?
49. What is a key in a relational database table?

**EXERCISES (CONTINUED)**

50. Specify the schema for the database table of Figure 12.9.
51. How are relationships represented in a relational database?
52. Define an SQL query that returns all attributes of all records in the *Customer* table.
53. Define an SQL query that returns the *MovieId* number and title of all movies that have an R rating.
54. Define an SQL query that returns the address of every customer in the *Customer* table who lives on Lois Lane.
55. Define an SQL statement that inserts the movie *Armageddon* into the *Movie* table.
56. Define an SQL statement that changes the address of Amy Stevens in the *Customer* table.
57. Define an SQL statement that deletes the customer with a *CustomerId* of 103.
58. What is an ER diagram?
59. How are entities and relationships represented in an ER diagram?
60. How are attributes represented in an ER diagram?
61. What are cardinality constraints, and how are they shown in ER diagrams?
62. What are the three general cardinality constraints?
63. Design a database that stores data about the books in a library, the students who use them, and the ability to check out books for a period of time. Create an ER diagram and sample tables.
64. Design a database that stores data about the courses taught at a university, the professors who teach those courses, and the students who take those courses. Create an ER diagram and sample tables.
65. What were some of the web-based technologies that allowed e-commerce to become viable?
66. What is big data? How does it relate to spreadsheets and databases?
67. Name three challenges in big data analysis.

**THOUGHT QUESTIONS**

1. Other than the examples given in this chapter, think of five situations for which you might set up a spreadsheet.
2. Other than the examples given in this chapter, think of five situations for which you might set up a database.
3. Does the use of computerized databases mean that we can do away with paper files? What sorts of paper files might still be needed?
4. One of the reasons that U.S. elections are so costly is that they cover such a large span of time. The United Kingdom has only about six weeks in which the candidates campaign. Would shortening the election cycle be a good idea? Does the use of the Internet to disseminate information affect your answer?
5. How has the Internet changed the funding of political campaigns? Is the change in funding a good or a bad thing?
6. Were you actively involved in any recent elections? From where did you get your information? How do you think those sources of information influenced your positions?
7. Is the Internet helping or hurting the democratic process?
8. Do you think that the Internet has supported political extremes?
9. What do you think of Donald Trump's use of Twitter?

## Laying the Groundwork

- 1 The Big Picture

## The Information Layer

- 2 Binary Values and Number Systems
- 3 Data Representation

## The Hardware Layer

- 4 Gates and Circuits
- 5 Computing Components

## The Programming Layer

- 6 Low-Level Programming Languages and Pseudocode
- 7 Problem Solving and Algorithms
- 8 Abstract Data Types and Subprograms
- 9 Object-Oriented Design and High-Level Programming Languages

## The Operating Systems Layer

- 10 Operating Systems
- 11 File Systems and Directories

## The Applications Layer

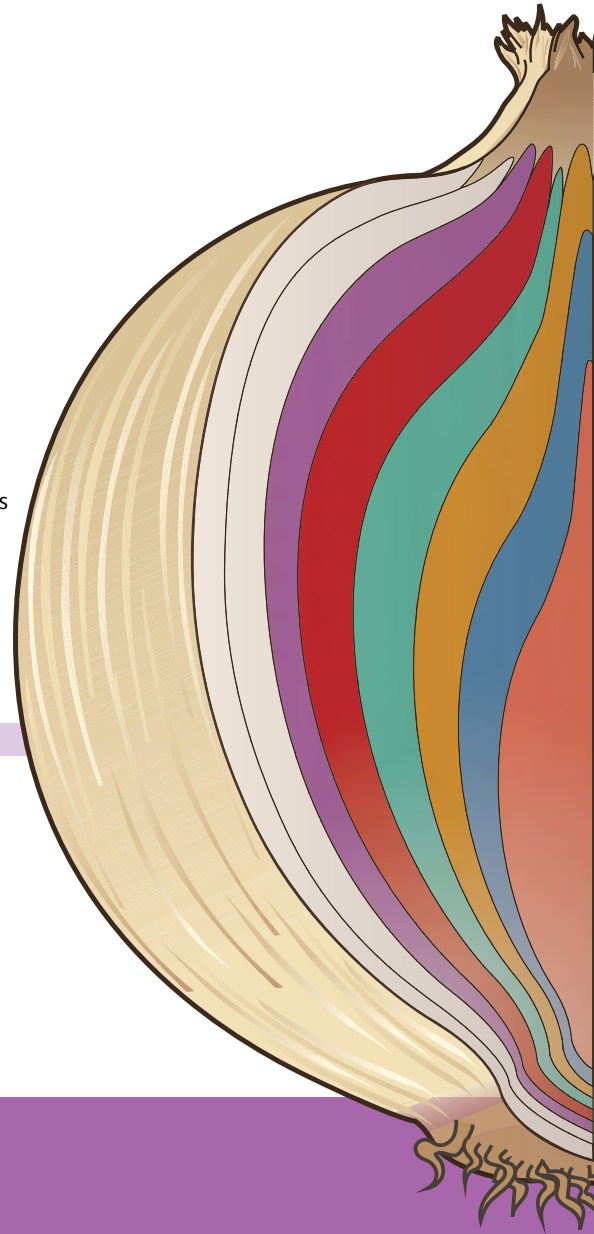
- 12 Information Systems
- 13 Artificial Intelligence
- 14 Simulation, Graphics, Gaming, and Other Applications

## The Communications Layer

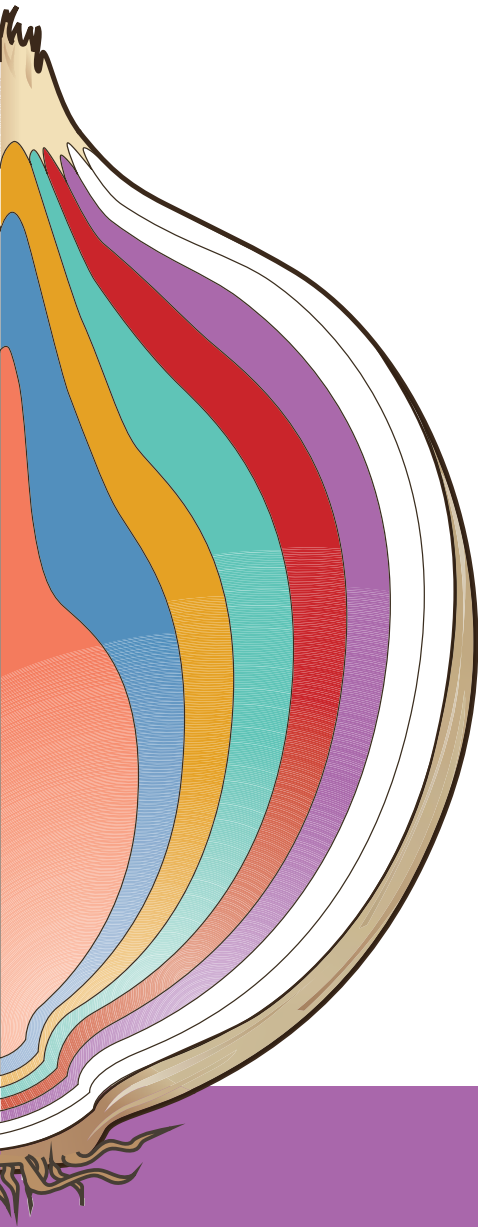
- 15 Networks
- 16 The World Wide Web
- 17 Computer Security

## In Conclusion

- 18 Limitations of Computing



# THE APPLICATIONS LAYER



## 13

# ARTIFICIAL INTELLIGENCE

The subdiscipline of computing called *artificial intelligence* (AI) is important in many ways. To many people it represents the future of computing—the evolution of a machine to make it more like a human. To others it is an avenue for applying new and different technologies to problem solving.

The term *artificial intelligence* probably conjures up various images in your mind, such as a computer playing chess or a robot doing household chores. These are certainly aspects of AI, but it goes far beyond that. AI techniques affect the way we develop many types of application programs, from the mundane to the fantastic. The world of artificial intelligence opens doors that no other aspect of computing does. Its role in the development of state-of-the-art application programs is crucial.

## GOALS

After studying this chapter, you should be able to:

- distinguish between the types of problems that humans do best and those that computers do best.
- explain the Turing test.
- define *knowledge representation* and demonstrate how knowledge is represented in a semantic network.
- develop a search tree for simple scenarios.
- explain the processing of an expert system.
- explain the processing of biological and artificial neural networks.
- list the various aspects of natural-language processing.
- explain the types of ambiguities in natural-language comprehension.



## 13.1 Thinking Machines

Computers are amazing devices. They can draw complex three-dimensional images, process the payroll of an entire corporation, and determine whether the bridge you're building will stand up to the pressure of the traffic expected. Yet they may have trouble understanding a simple conversation and might not be able to distinguish between a table and a chair.

Certainly a computer can do some things better than a human can. For example, if you are given the task of adding 1000 four-digit numbers together using pencil and paper, you could do it. But the task would take you quite a long time, and you very likely would make errors while performing the calculations. A computer could perform the same calculation in a fraction of a second without error.

However, if you are asked to point out the cat in the picture shown in [FIGURE 13.1](#), you could do it without hesitation. A computer, by contrast, would have difficulty making that identification and might very well get it wrong. Humans bring a great deal of knowledge and reasoning



**FIGURE 13.1** A computer might have trouble identifying the cat in this picture

Courtesy of Amy Rose

capability to these types of problems; we are still struggling with ways to perform human-like reasoning using a computer.

In our modern state of technology, computers are good at computation, but less adept at things that require intelligence. The field of **artificial intelligence (AI)** is the study of computer systems that attempt to model and apply the intelligence of the human mind.

## The Turing Test

In 1950, English mathematician Alan Turing wrote a landmark paper that asked the question: Can machines think? After carefully defining terms such as *intelligence* and *thinking*, he ultimately concluded that we would eventually be able to create a computer that thinks. But then he asked another question: How will we know when we've succeeded?

His answer to that question came to be called the **Turing test**, which is used to empirically determine whether a computer has achieved intelligence. The test is based on whether a computer could fool a human into believing that the computer is another human.

Variations on Turing tests have been defined over the years, but we focus on the basic concept here. The test is set up as follows: A human interrogator sits in a room and uses a computer terminal to communicate with two respondents, A and B. The interrogator knows that one respondent is human and the other is a computer, but doesn't know which is which. (See [FIGURE 13.2](#).) After holding conversations with both A and B, the interrogator must decide which respondent is the computer. This procedure is repeated with numerous human interrogators. The premise is that if the computer could fool enough interrogators, then it could be considered intelligent.

Some people argue that the Turing test is a good test for intelligence because it requires that a computer possess a wide range of knowledge and have the flexibility necessary to deal with changes in conversation. To fool a human interrogator, the knowledge required by the computer goes beyond facts; it includes an awareness of human behavior and emotions.

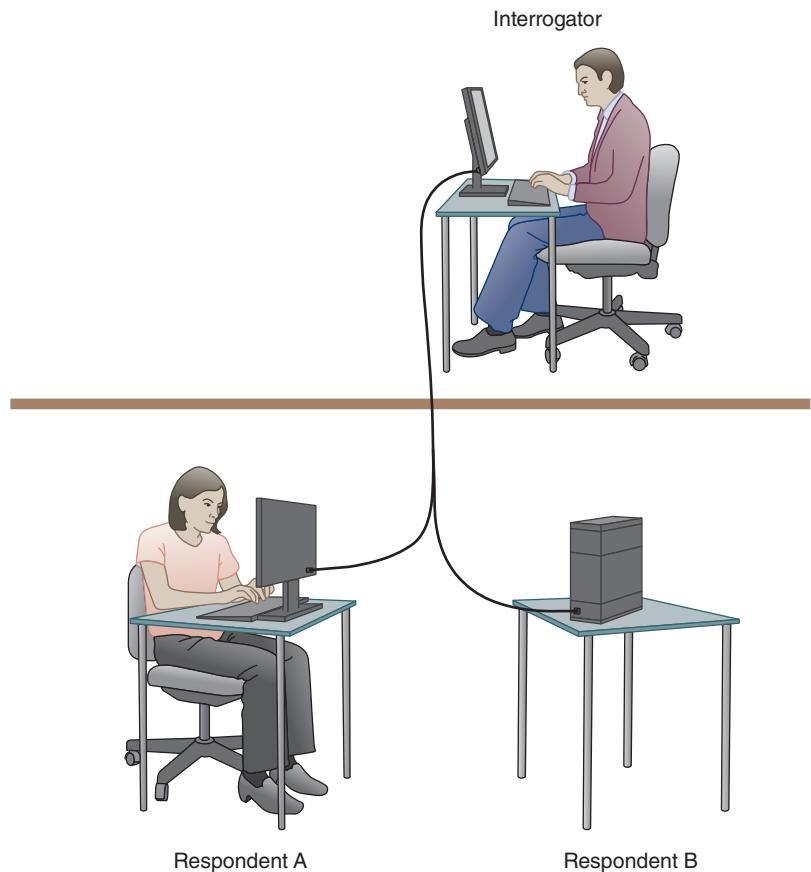
Others argue that the Turing test doesn't really demonstrate that a computer understands language discourse, which is necessary for true intelligence. They suggest that a program could simulate language comprehension, perhaps enough to pass the Turing test, but that alone does not make the computer intelligent.

A computer that passes the Turing test would demonstrate **weak equivalence**, meaning that the two systems (human and computer) are equivalent in results (output) but do not arrive at those results in

**Artificial intelligence (AI)** The study of computer systems that model and apply the intelligence of the human mind

**Turing test** A behavioral approach to determining whether a computer system is intelligent

**Weak equivalence** The equality of two systems based on their results



**FIGURE 13.2** In a Turing test, the interrogator must determine which respondent is the computer and which is the human

#### Strong equivalence

The equality of two systems based on their results and the process by which they arrive at those results

the same way. **Strong equivalence** indicates that two systems use the same internal processes to produce results. Some AI researchers assert that true artificial intelligence will not exist until we have achieved strong equivalence—that is, until we create a machine that processes information as the human mind does.

New York philanthropist Hugh Loebner organized the first formal instantiation of the Turing test. This competition has been run annually since 1991. A grand prize of \$100,000 and a solid gold medal will be awarded for the first computer whose responses are indistinguishable from a human's (including text, visual, and audio input). So far the grand prize remains up for grabs. A prize of \$2000 and a bronze medal is awarded each year for the computer that is determined to be the most human-like, relative to the

rest of the competition that year. The **Loebner prize** contest has become an important annual event for computing enthusiasts interested in artificial intelligence.

Various programs, often referred to as **chatbots**, have been developed to perform this kind of conversational interaction between a computer and a person. Many are available through the Web and focus on a particular topic. Depending on how well they are designed, these programs can carry on a reasonable conversation. In most cases, though, it doesn't take long for the user to discover awkward moments in the conversation that betray the fact that a human mind is not determining the responses.

**Loebner prize**

The first formal instantiation of the Turing test, held annually

**Chatbot** A program designed to carry on a conversation with a human user

## Aspects of AI

The field of artificial intelligence has many branches. Our overall goal in this chapter is to give you some insight into the primary issues involved and the challenges yet to be overcome. In the remaining sections of this chapter, we explore the following issues in the world of AI:

- Knowledge representation—the techniques used to represent knowledge so that a computer system can apply it to intelligent problem solving
- Expert systems—computer systems that embody the knowledge of human experts
- Neural networks—computer systems that mimic the processing of the human brain
- Natural-language processing—the challenge of processing languages that humans use to communicate
- Robotics—the study of robots

## 13.2 Knowledge Representation

The knowledge we need to represent an object or event varies based on the situation. Depending on the problem we are trying to solve, we need specific information. For example, if we are trying to analyze family relationships, it's important to know that Fred is Cathy's father, but not that Fred is a plumber or that Cathy owns a pickup truck. Furthermore, not only do we need particular information, but we also need it in a form that allows us to search and process that information efficiently.

There are many ways to represent knowledge. For example, we could describe it in natural language. That is, we could write an English paragraph describing, for instance, a student and the ways in which

© Artur Debat/Getty Images; © Alan Dyer/Stocktrek Images/Getty Images

## Herbert A. Simon

Herbert A. Simon was a Renaissance man of modern times. His website included sections on computer science, psychology, and philosophy, yet his PhD was in political science and his Nobel Prize was in economics.

Simon was born in Milwaukee in 1916. His father was an engineer who became a patent attorney, and his mother was an accomplished pianist. Simon received his undergraduate degree in 1936 from the University of Chicago and worked for several years as an editor and administrator. He completed his PhD in political science at the University of Chicago in 1943 and then began a 58-year academic career, the last 52 years of which were at Carnegie Mellon.

In 1955, Simon, Allen Newell, and J. C. Shaw (a programmer) created Logic Theorist, a program that could discover geometric theorem proofs. At about the same time, Simon was working with E. A. Feigenbaum on EPAM, a program that modeled their theory of human perception and memory. These programs and the subsequent series of papers on the simulation of human thinking, problem solving, and verbal learning marked the beginning of the field of artificial intelligence. In 1988, Simon and Newell received the Turing Award of the Association for Computing Machinery for their work in human problem solving. In 1995, Simon received the

Research Excellence Award of the International Joint Conference on Artificial Intelligence.

Simon's interest in information processing and decision making led him to develop his economic theory of "bounded rationality," for which he received the 1978 Nobel Prize in economics. Classical economics had argued that people make rational choices so as to get the best item at the best price. Simon reasoned that determining the "best" choice was impossible because there are too many choices and too little time to analyze them. Instead, he argued, people choose the first option that is good enough to meet their needs. His Nobel Prize citation read "for his pioneering research into the decision-making process within economic organizations."

Simon remained extraordinarily productive throughout his long career. His bibliography contains 173 entries before 1960, 168 in the 1960s, 154 in the 1970s, 207 in the 1980s, and 236 in the 1990s. Outside of his professional life, Simon enjoyed playing the piano, especially with friends who played violin, viola, and other instruments. He died in February 2001, having continued his research and interactions with students until just a few weeks before his death.



Courtesy of Carnegie Mellon University

the student relates to the world. However, although natural language is very descriptive, it doesn't lend itself to efficient processing. Alternatively, we could formalize the language, by describing a student using an almost mathematical notation. This formalization lends itself to more rigorous computer processing, but it is difficult to learn and use correctly.

In general, we want to create a logical view of the data, independent of its actual underlying implementation, so that it can be processed in specific ways. In the world of artificial intelligence, the information we want to capture often leads to new and interesting data representations. We want to capture not only facts, but also relationships. The kind of problem we are trying to solve may dictate the structure we impose on the data.

As specific problem areas have been investigated, new techniques for representing knowledge have been developed. We examine two in this section: semantic networks and search trees.

## Semantic Networks

A **semantic network** is a knowledge representation technique that focuses on the relationships between objects. A directed graph is used to represent a semantic network or net. The nodes of the graph represent objects, and the arrows between nodes represent relationships. The arrows are labeled to indicate the types of relationships that exist.

Semantic nets borrow many object-oriented concepts, which were discussed in Chapter 9, including inheritance and instantiation. An inheritance relationship indicates that one object *is-a* more specific version of another object. Instantiation is the relationship between an actual object and something that describes it (like a class).

Examine the semantic network shown in [FIGURE 13.3](#). It has several *is-a* relationships and several *instance-of* relationships. But it also has several other types of relationships, such as *lives-in* (John lives in Heritage Acres). There are essentially no restrictions on the types of relationships that can be modeled in a semantic network.

Many more relationships could be represented in this semantic net. For instance, we could have indicated that any person is either left- or right-handed, that John owns a car that is a Honda, or that every student has a grade point average. The relationships that we represent are completely our choice, based on the information we need to answer the kinds of questions that we will face.

The way in which we establish the relationships can vary as well. For example, instead of showing that individual students live in particular dwellings, we could show that dwellings house certain people. In other words, we could turn those arrows around, changing the *lives-in* relationship to a *houses* relationship. Again, the choice is ours as we design the network. Which approach best describes the kind of issues we address? In some situations we may choose to represent both relationships.

The types of relationships represented determine which questions are easily answered, which are more difficult to answer, and which cannot

### Semantic network

A knowledge representation technique that represents the relationships among objects



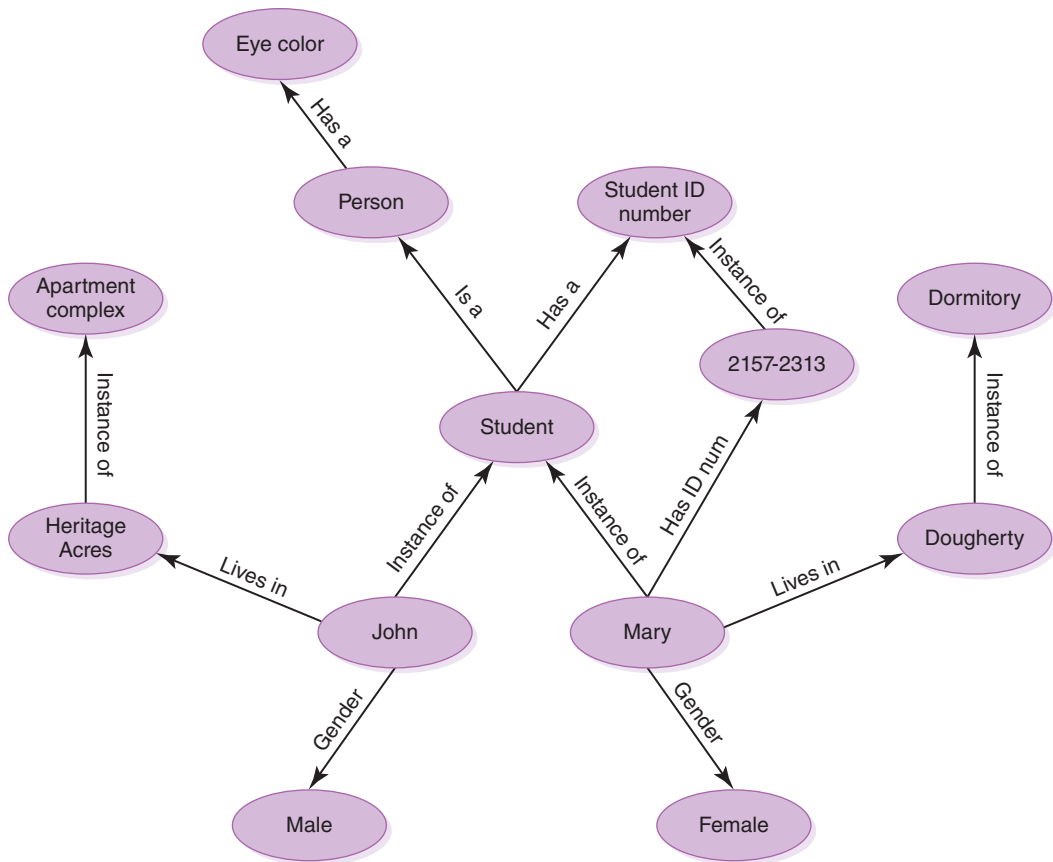


FIGURE 13.3 A semantic network

be answered. For example, the semantic net in Figure 13.3 makes it fairly simple to answer the following questions:

- Is Mary a student?
- What is the gender of John?
- Does Mary live in a dorm or an apartment?
- What is Mary's student ID number?

However, the following questions are more difficult to answer with this network:

- How many students are female and how many are male?
- Who lives in Dougherty Hall?

Note that the information to answer these questions is present in the network; it's just not as easy to process. These last questions require the

ability to easily find all students, and there are no relationships that make this information easy to obtain. This network is designed more for representing the relationships that individual students have to the world at large.

This network cannot be used to answer the following questions, because the knowledge required is simply not represented:

- What kind of car does John drive?
- What color are Mary's eyes?

We know that Mary has an eye color, because she is a student, all students are people, and all people have a particular eye color. We just don't know what Mary's particular eye color is, given the information stored in this network.

A semantic network is a powerful, versatile way to represent a lot of information. The challenge is to model the right relationships and to populate (fill in) the network with accurate and complete data.

## Search Trees

In Chapter 8, we mentioned the use of tree structures to organize data. Such structures play an important role in artificial intelligence. For example, we can use a tree to represent possible alternatives in adversarial situations, such as game playing.

A **search tree** is a structure that represents all possible moves in a game, for both you and your opponent. You can create a game program that maximizes its chances to win. In some cases it may even be able to guarantee a win.

In search trees, the paths down a tree represent the series of decisions made by the players. A decision made at one level dictates the options left to the next player. Each node of the tree represents a move based on all other moves that have occurred thus far in the game.

Let's define a simplified variation of a game called *Nim* to use as an example. In our version, there are a certain number of spaces in a row. The first player may place one, two, or three Xs in the leftmost spaces. The second player may then place one, two, or three Os immediately adjacent to the Xs. Play continues back and forth. The goal is to place your mark in the last (rightmost) space.

Here is an example of a play of our version of Nim using nine spaces:

```
Initial: _ _ _ _ _ _ _ _ _
Player 1: X X X _ _ _ _ _ _
Player 2: X X X O _ _ _ _ _
```

?

### The power of television

It has been observed that the then relatively recent invention of television was responsible for getting John F. Kennedy elected in 1960. In a presidential debate with the Republican candidate, Richard Nixon, Kennedy was seen by television audiences as handsome, erudite, and relaxed, whereas Nixon was seen as ill at ease and sporting a five o'clock shadow. The debate, it is said, swayed just enough voters to give Kennedy the election. Some disgruntled analysts suggested that had television existed in 1860, the great but physically unattractive Abraham Lincoln would not have been elected. Did television rob something from the democratic process? How do you think the Internet has affected it?

**Search tree** A structure that represents alternatives in adversarial situations, such as game playing



## Chapter 13: Artificial Intelligence

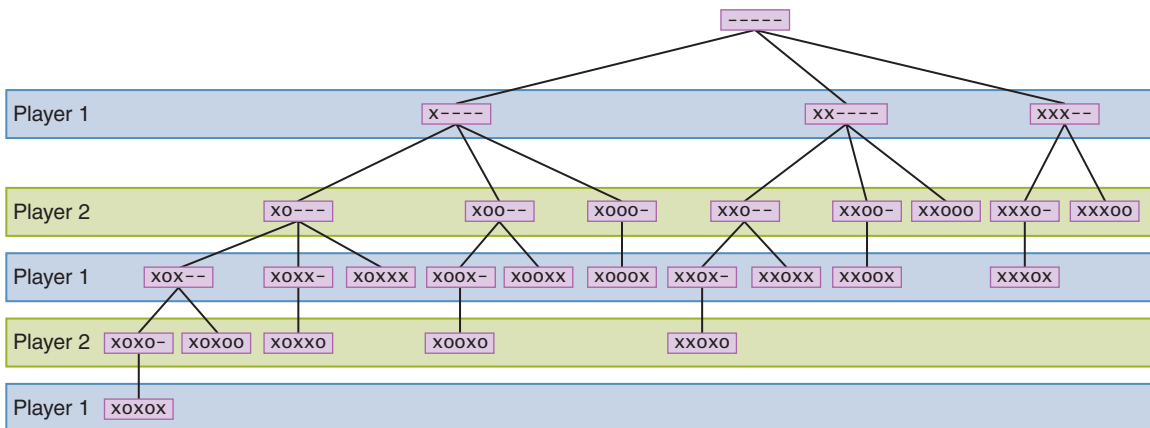
Player 1: X X X 0 X \_ \_ \_ \_  
 Player 2: X X X 0 X 0 0 \_ \_  
 Player 1: X X X 0 X 0 0 X X    Player 1 wins.

The search tree in [FIGURE 13.4](#) shows all possible moves in our version of the game using only five spaces (rather than the nine spaces used in the preceding example). At the root of the tree, all spaces are initially empty. The next level shows the three options the first player has (to place one, two, or three Xs). At the third level, the tree shows all options that Player 2 has, given the move that Player 1 already made.

Note that when a large number of marks are made in one turn, fewer options may be available to the next player, and the paths down the tree tend to be shorter. Follow the various paths down from the root, noting the different options taken by each player. Every single option in our simplified game is represented in this tree.

We've deliberately simplified the game of Nim so that we can show a simple search tree. The real game of Nim has some important differences—for example, there are multiple rows, and items are removed instead of added. However, even our simplified version demonstrates several interesting mathematical ideas.

The concepts of search tree analysis can be applied nicely to other, more complicated games such as chess. In such complex games the search trees are far more complicated, having many more nodes and paths. Think about all the possible moves you might initially make in a chess game. Then consider all the possible moves your opponent might make in response. A full chess search tree contains all possible moves at each level,



**FIGURE 13.4** A search tree for a simplified version of Nim

given the current status of the board. Because these trees are so large, only a fraction of the tree can be analyzed in a reasonable time limit, even with modern computing power.

As machines have become faster, more of the search tree can be analyzed, but still not all of the branches. Programmers have come up with ways to “prune” the search trees, eliminating paths that no human player would consider reasonable. Even so, the trees are too large to completely analyze for each move.

This leaves us with a question: Do we choose a **depth-first approach**, analyzing selective paths all the way down the tree that we hope will result in successful moves? Or do we choose a **breadth-first approach**, analyzing all possible paths but only for a short distance down the tree? Both approaches, shown in [FIGURE 13.5](#), may miss key possibilities. While this issue has been debated among AI programmers for many years, a breadth-first approach tends to yield the best results. It seems that it’s better to make consistently error-free conservative moves than to occasionally make spectacular moves.

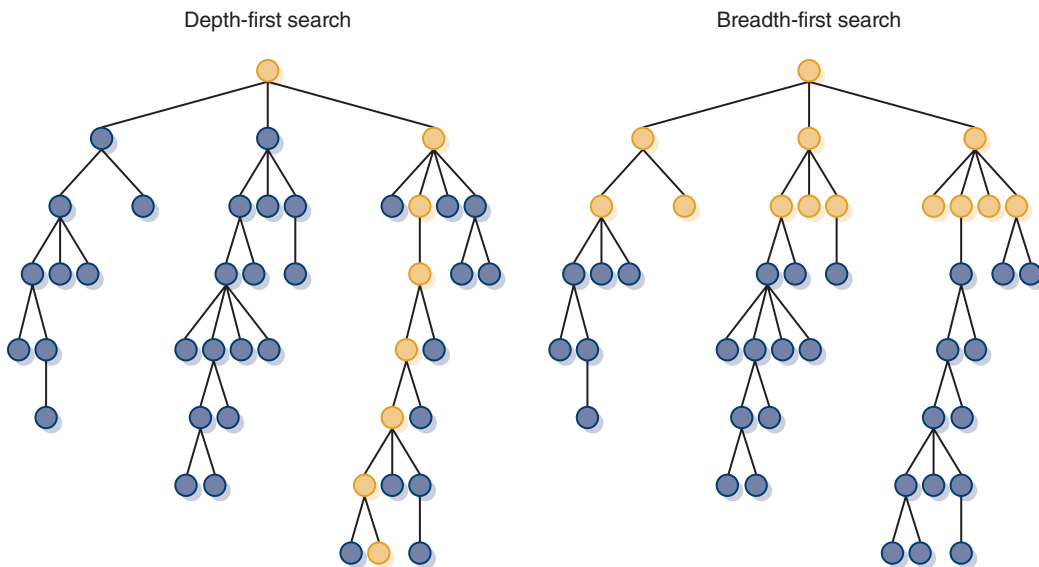
Programs that play chess at the master level have become commonplace. In 1997, the computer chess program Deep Blue, developed by IBM using an expert system, defeated world champion Garry Kasparov in a six-game match. This event marked the first time a computer had defeated a human champion at master-level play.

#### Depth-first approach

Searching down the paths of a tree prior to searching across levels

#### Breadth-first approach

Searching across levels of a tree prior to searching down specific paths



**FIGURE 13.5** Depth-first and breadth-first searches

## 13.3 Expert Systems

We often rely on experts for their unique knowledge and understanding of a particular field. We go to a doctor when we have a health problem, an auto mechanic when our car won't start, and an engineer when we need to build something.

A **knowledge-based system** is a software system that embodies and uses a specific set of information (organized data) from which it extracts and processes particular pieces. The terms **expert system** and *knowledge-based system* are often used interchangeably, although expert systems usually embody the knowledge of a specialized field, modeling the expertise of a professional in that field. A user consults an expert system when confronted with a particular problem, and the system uses its expertise to advise the user how to proceed.

An expert system uses a set of rules to guide its processing, so it is called a **rule-based system**. The set of rules in an expert system is referred to as its *knowledge base*. The **inference engine** is the part of the software that determines how the rules are followed and, therefore, which conclusions can be drawn.

A doctor is the living equivalent of an expert system. He or she gathers data by asking you questions and running tests. Your initial answers and the test results may lead to more questions and more tests. The rules embodied by the doctor's knowledge allow him or her to know which questions to ask next. The doctor then uses the information to rule out various possibilities and eventually narrows the alternatives to a specific diagnosis. Once the problem is identified, that specific knowledge allows the doctor to suggest the appropriate treatment.

Let's walk through an example of expert-system processing. Suppose you wanted to answer this question: What type of treatment should I put on my lawn?

An expert system that embodies the knowledge of a gardener would be able to guide you in this decision. Let's define a few variables so that we can abbreviate the rules in our gardening system:

NONE—apply no treatment at this time

TURF—apply a turf-building treatment

WEED—apply a weed-killing treatment

BUG—apply a bug-killing treatment

FEED—apply a basic fertilizer treatment

WEEDFEED—apply a weed-killing and fertilizer combination treatment

### Knowledge-based system

Software that uses a specific set of information

### Expert system

A software system based on the knowledge of human experts

### Rule-based system

A software system based on a set of *if-then* rules

### Inference engine

The software that processes rules to draw conclusions

These values represent various conclusions that the expert system might draw after analyzing the situation. The following Boolean variables represent the current state of the lawn:

BARE—the lawn has large, bare areas  
 SPARSE—the lawn is generally thin  
 WEEDS—the lawn contains many weeds  
 BUGS—the lawn shows evidence of bugs

We assume that initially the system has no direct data regarding the status of the lawn. The user would have to be questioned to determine, for instance, if the lawn has large, bare areas. Other data may be available directly to the system through some calculation or in some type of database:

LAST—the last date a lawn treatment was applied  
 CURRENT—the current date  
 SEASON—the current season

Now we can formulate some rules that our system can use to draw a conclusion. Rules take the form of *if-then* statements.

```
if (CURRENT - LAST < 30) then NONE
if (SEASON = winter) then not BUGS
if (BARE) then TURF
if (SPARSE and not WEEDS) then FEED
if (BUGS and not SPARSE) then BUG
if (WEEDS and not SPARSE) then WEED
if (WEEDS and SPARSE) then WEEDFEED
```

Note that this is only a sample of the types of rules that may exist in such a system. Real expert systems may incorporate thousands of rules to help analyze a situation. The rules presented here do not cover all situations, even in our small example.

When executed, the inference engine selects a rule to determine whether it is applicable. That determination may be made only by questioning the user. If it is applicable, that rule may affect the applicability of other rules. The inference engine continues to apply rules until no applicable rules remain. Don't think of the rules as being a linear path (followed in sequence); instead, the inference engine applies whichever rules it can and continually loops until it reaches a conclusion.

An execution of our inference engine may result in the following interaction:

```
System: Does the lawn have large, bare areas?
User: No
System: Does the lawn show evidence of bugs?
User: No
```

### LISP is the language for AI

?

LISP (LISt Processor) is one of the most popular programming languages for AI. LISP's essential data structure is an ordered sequence of elements called a *list*. The elements in this list may be indivisible entities or they may be other lists. A list can be used to represent an almost limitless number of things, from expert rules to computer programs to thought processes to system components. To make decisions, LISP programs rely on recursion rather than looping. LISP and its dialects belong to the functional paradigm of languages.<sup>1</sup>

## Chapter 13: Artificial Intelligence

System: Is the lawn generally thin?

User: Yes

System: Does the lawn contain significant weeds?

User: Yes

System: You should apply a weed-killing and fertilizer combination treatment.

Note that the system doesn't ask about things it can look up, such as the date of the last treatment. And apparently our scenario didn't take place in winter, because the system asked about a potential bug problem. If it had been winter, the bug issue would have already been eliminated.

An expert system has many advantages over other advising techniques. First, it is goal oriented: It doesn't focus on abstract or theoretical information, but rather focuses on solving a specific problem. Second, it is efficient: It records previous responses and doesn't ask irrelevant questions. Third, a real expert system, through a carefully constructed set of rules, can usually provide useful guidance even if you don't know the answers to some questions.

## 13.4 Neural Networks

As mentioned earlier, some artificial intelligence researchers focus on how the human brain actually works and try to construct computing devices that work in similar ways. An **artificial neural network** in a computer attempts to mimic the actions of the neural networks of the human body. Let's first look at how a biological neural network works.

### Biological Neural Networks

A neuron is a single cell that conducts a chemically based electronic signal. The human brain contains billions of neurons connected into a network. At any point in time a neuron is in either an *excited* state or an *inhibited* state. An excited neuron conducts a strong signal; an inhibited neuron conducts a weak signal. A series of connected neurons forms a pathway. The signal along a particular pathway is strengthened or weakened according to the state of the neurons it passes through. A series of excited neurons creates a strong pathway.

A biological neuron has multiple input tentacles called *dendrites* and one primary output tentacle called an *axon*. The dendrites of one neuron pick up the signals from the axons of other neurons to form the neural network. The gap between an axon and a dendrite is called a *synapse*. (See **FIGURE 13.6**.) The chemical composition of a synapse tempers the strength of its input signal. The output of a neuron on its axon is a function of all of its input signals.

**Artificial neural network** A computer representation of knowledge that attempts to mimic the neural networks of the human body

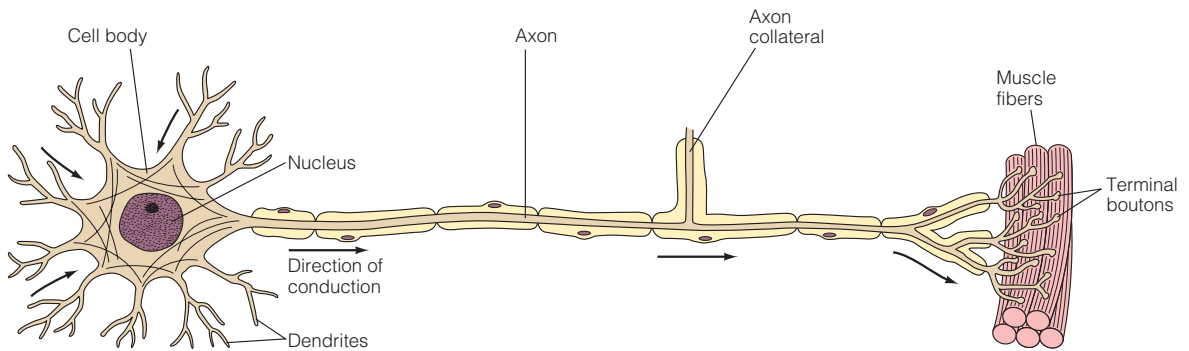


FIGURE 13.6 A biological neuron

A neuron accepts multiple input signals and then controls the contribution of each signal based on the “importance” the corresponding synapse assigns to it. If enough of these weighted input signals are strong, the neuron enters an excited state and produces a strong output signal. If enough of the input signals are weak or are weakened by the weighting factor of that signal’s synapse, the neuron enters an inhibited state and produces a weak output signal.

Neurons fire, or pulsate, up to 1000 times per second, so the pathways along the neural nets are in a constant state of flux. The activity of our brain causes some pathways to strengthen and others to weaken. As we learn new things, new strong neural pathways form in our brain.

## Artificial Neural Networks

Each processing element in an artificial neural network is analogous to a biological neuron. An element accepts a certain number of input values and produces a single output value of either 0 or 1. These input values come from the output of other elements in the network, so each input value is either 0 or 1. Associated with each input value is a numeric weight. The **effective weight** of the element is defined as the sum of the weights multiplied by their respective input values.

Suppose an artificial neuron accepts three input values:  $v_1$ ,  $v_2$ , and  $v_3$ . Associated with each input value is a weight:  $w_1$ ,  $w_2$ , and  $w_3$ . The effective weight is therefore

$$v_1 * w_1 + v_2 * w_2 + v_3 * w_3$$

Each element has a numeric threshold value. The element compares the effective weight to this threshold value. If the effective weight exceeds

**Effective weight** In an artificial neuron, the sum of the weights multiplied by the corresponding input values

the threshold, the unit produces an output value of 1. If it does not exceed the threshold, it produces an output value of 0.

This processing closely mirrors the activity of a biological neuron. The input values correspond to the signals passed in by the dendrites. The weight values correspond to the controlling effect of the synapse for each input signal. The computation and use of the threshold value correspond to the neuron producing a strong signal if “enough” of the weighted input signals are strong.

Let’s look at an actual example. In this case, we assume there are four inputs to the processing element. There are, therefore, four corresponding weight factors. Suppose the input values are 1, 1, 0, and 0; the corresponding weights are 4, -2, -5, and -2; and the threshold value for the element is 4. The effective weight is

$$1(4) + 1(-2) + 0(-5) + 0(-2)$$

or 2. Because the effective weight does not exceed the threshold value, the output of this element is 0.

Although the input values are either 0 or 1, the weights can be any value at all. They can even be negative. We’ve used integers for the weights and threshold values in our example, but they can be real numbers as well.

The output of each element is truly a function of all pieces of the puzzle. If the input signal is 0, its weight is irrelevant. If the input signal is 1, the magnitude of the weight, and whether it is positive or negative, greatly affects the effective weight. And no matter what effective weight is computed, it’s viewed relative to the threshold value of that element. That is, an effective weight of 15 may be enough for one element to produce an output of 1, but for another element it results in an output of 0.

The pathways established in an artificial neural net are a function of its individual processing elements. And the output of each processing element changes on the basis of the input signals, the weights, and/or the threshold values. But the input signals are really just output signals from other elements. Therefore, we affect the processing of a neural net by changing the weights and threshold value in individual processing elements.

The process of adjusting the weights and threshold values in a neural net is called **training**. A neural net can be trained to produce whatever results are required. Initially, a neural net may be set up with random weights, threshold values, and initial inputs. The results are compared to the desired results and changes are made. This process continues until the desired results are achieved.

**Training** The process of adjusting the weights and threshold values in a neural net to get a desired outcome

Consider the problem we posed at the beginning of this chapter: Find a cat in a photograph. Suppose a neural net is used to address this problem, using one output value per pixel. Our goal is to produce an output value of 1 for every pixel that contributes to the image of the cat, and to produce a 0 if it does not. The input values for the network could come from some representation of the color of the pixels. We then train the network using multiple pictures containing cats, reinforcing weights and thresholds that lead to the desired (correct) output.

Think about how complicated this problem is! Cats come in all shapes, sizes, and colors. They can be oriented in a picture in thousands of ways. They might blend into their background (in the picture) or they might not. A neural net for this problem would be incredibly large, taking all kinds of situations into account. The more training we give the network, however, the more likely it will produce accurate results in the future.

What else are neural nets good for? They have been used successfully in thousands of application areas, in both business and scientific endeavors. They can be used to determine whether an applicant should be given a mortgage. They can be used in optical character recognition, allowing a computer to “read” a printed document. They can even be used to detect plastic explosives in luggage at airports.

The versatility of neural nets lies in the fact that there is no inherent meaning in the weights and threshold values of the network. Their meaning comes from the interpretation we apply to them.

## 13.5 Natural-Language Processing

In a science fiction movie, it’s not uncommon to have a human interact with a computer by simply talking to it. The captain of a spaceship might say, “Computer, what is the nearest starbase with medical facilities sufficient to handle Laharman’s syndrome?” The computer might then respond, “Starbase 42 is 14.7 light-years away and has the necessary facilities.”

How far is this science fiction from science fact? Ignoring space travel and advanced medicine for now, why don’t we interact with computers just by talking to them? To a limited extent, we can. We don’t tend to have free-flowing verbal conversations yet, but we’ve certainly made headway. Some computers can be set up to respond to specific verbal commands.

Devices such as the Amazon Echo and Google Home are examples of modern devices that rely on a verbal interface. These machines are sometimes called smart speakers (see [FIGURE 13.7](#)). You can simply ask questions, such as “What’s the weather?” or “How do you spell Mississippi?” and the device will respond. To get the device to realize that you are talking to

### Voice recognition

Using a computer to recognize the words spoken by a human

### Natural-language comprehension

Using a computer to apply a meaningful interpretation to human communication

### Voice synthesis

Using a computer to create the sound of human speech





**FIGURE 13.7** The Google Home and Amazon Echo smart speakers

© pianodiaphragm/Shutterstock; © James W Copeland/Shutterstock

it, you preface the question with a key phrase, such as “Hey, Google” or “Alexa” (the Echo’s alter ego). You can also use these devices as speakers for streaming music, to report the news, and for playing games.

To probe this issue further, we must first realize that three basic types of processing occur during human/computer voice interaction:

- **Voice recognition**—recognizing human words
- **Natural-language comprehension**—interpreting human communication
- **Voice synthesis**—re-creating human speech

The computer must first recognize the distinct words that are being spoken to it, then understand the meaning of those words, and finally (after determining the answer) produce the words that make up the response.

Common to all of these problems is the fact that we are using a **natural language**, which can be any language that humans use to communicate, such as English, Farsi, or Russian. Natural languages have inherent grammatical irregularities and ambiguities that make some of this processing quite challenging.

Computing technology has made great strides in all of these areas, albeit in some areas more than others. Let’s explore each one in more detail.

#### Natural language

Languages that humans use to communicate, such as English

## Voice Synthesis

Voice synthesis is generally a well-understood problem. There are two basic approaches to the solution: dynamic voice generation and recorded speech.

To generate voice output using dynamic voice generation, a computer examines the letters that make up a word and produces the sequence of sounds that correspond to those letters in an attempt to vocalize the word. Human speech has been categorized into specific sound units called **phonemes**. The phonemes for American English are shown in **FIGURE 13.8**.

After selecting the appropriate phonemes, the computer may modify the pitch of the phoneme based on the context in which it is used. The duration of each phoneme must also be determined. Finally, the phonemes are combined to form individual words. The sounds themselves are produced electronically, designed to mimic the way a human vocal track produces the sounds.

The challenges to this approach include the fact that the way we pronounce words varies greatly among humans, and the rules governing how letters contribute to the sound of a word are not consistent. Dynamic voice-generation systems often sound mechanical and stilted, though the words are usually recognizable.

**Phonemes** The set of fundamental sounds made in any given natural language

| Consonants |                   |         |                  | Vowels  |                     |
|------------|-------------------|---------|------------------|---------|---------------------|
| Symbols    | Examples          | Symbols | Examples         | Symbols | Examples            |
| p          | Pipe              | k       | Kick, cat        | i       | Eel, sea, see       |
| b          | Babe              | g       | Get              | I       | Ill, bill           |
| m          | Maim              | ŋ       | Sing             | e       | Ale, aim, day       |
| f          | Fee, phone, rough | ʃ       | Shoe, ash, sugar | ɛ       | Elk, bet, bear      |
| v          | Vie, love         | ʒ       | Measure          | æ       | At, mat             |
| θ          | Thin, bath        | č       | Chat, batch      | u       | Due, new, zoo       |
| ð          | The, bathe        | ǰ       | Jaw, judge, gin  | ʊ       | Book, sugar         |
| t          | Tea, beat         | d       | Day, bad         | o       | Own, no, know       |
| n          | Nine              | ʔ       | Uh uh            | ɔ       | Aw, crawl, law, dog |
| l          | Law, ball         | s       | See, less, city  | a       | Hot, bar, dart      |
| r          | Run, bar          | z       | Zoo, booze       | ə       | Sir, nerd, bird     |
|            |                   |         |                  | ʌ       | Cut, bun            |

| Semi-vowels |             |
|-------------|-------------|
| w           | We          |
| h           | He          |
| j           | You, beyond |

| Diphthongs |             |
|------------|-------------|
| aj         | Bite, fight |
| aw         | Out, cow    |
| ɔj         | Boy, boil   |

**FIGURE 13.8** Phonemes for American English

The other approach to voice synthesis is to play digital recordings of a human voice saying specific words. Sentences are constructed by playing the appropriate words in the appropriate order. Sometimes common phrases or groups of words that are always used together are recorded as one entity. Telephone voice mail systems often use this approach: “Press 1 to leave a message for Alex Wakefield.”

Note that each word or phrase needed must be recorded separately. Furthermore, because words are pronounced differently in different contexts, some words may have to be recorded multiple times. For example, a word at the end of a question rises in pitch compared to its use in the middle of a sentence. As the need for flexibility increases, recorded solutions become problematic.

The dynamic voice-generation technique does not generally produce realistic human speech, but rather attempts to vocalize any words presented to it. Recorded playback is more realistic; it uses a real human voice but is limited in its vocabulary to the words that have been prerecorded, and it must have the memory capacity to store all the needed words. Generally, recorded playback is used when the number of words used is small.

## Voice Recognition

When having a conversation, you might need to have something repeated because you didn’t understand what the person said. It’s not that you didn’t understand the meaning of the words (you hadn’t gotten that far); you simply didn’t understand which words were being spoken. This might happen for several reasons.

First, the sounds that each person makes when speaking are unique. Every person has a unique shape to his or her mouth, tongue, throat, and nasal cavities that affect the pitch and resonance of the spoken voice. Thus we can say we “recognize” someone’s voice, identifying him or her from the way the words sound when spoken by that person. But that also means that each person says any given word somewhat differently, complicating the task of recognizing the word in the first place. Speech impediments, mumbling, volume, regional accents, and the health of the speaker further complicate this problem.

Furthermore, humans speak in a continuous, flowing manner. Words are strung together into sentences. Sometimes we speak so quickly that two words may sound like one. Humans have great abilities to divide the series of sounds into words, but even we can become confused if a person speaks too rapidly.

Related to this issue are the sounds of words themselves. Sometimes it's difficult to distinguish between phrases like "ice cream" and "I scream." And homonyms such as "I" and "eye" or "see" and "sea" sound exactly the same but are unique words. Humans can often clarify these situations by considering the context of the sentence, but that processing requires another level of comprehension.

So, if we humans occasionally have trouble understanding the words we say to each other, imagine how difficult this problem is for a computer. Modern voice-recognition systems still do not do well with continuous, conversational speech. The best success has been with systems that assume disjointed speech, in which words are clearly separated.

Further success is obtained when voice-recognition systems are "trained" to recognize a particular human's voice and a set of vocabulary words. A spoken voice can be recorded as a **voiceprint**, which plots the frequency changes of the sound produced by the voice when speaking a specific word. A human trains a voice-recognition system by speaking a word several times so that the computer can record an average voiceprint for that word by that person. Later, when a word is spoken, the recorded voiceprints can be compared to determine which word was spoken.

Voice-recognition systems that are not trained for specific voices and words do their best to recognize words by comparing generic voiceprints. While less accurate, using generic voiceprints avoids the time-consuming training process and allows anyone to use the system.

## Natural-Language Comprehension

Even if a computer recognizes the words that are spoken, it is another task entirely to understand the meaning of those words. This is the most challenging aspect of natural-language processing. Natural language is inherently ambiguous, meaning that the same syntactic structure could have multiple valid interpretations. These ambiguities can arise for several reasons.

One problem is that a single word can have multiple definitions and can even represent multiple parts of speech. The word *light*, for instance, can be both a noun and a verb. This is referred to as a **lexical ambiguity**. A computer attempting to apply meaning to a sentence would have to determine how the word was being used. Consider the following sentence:

*Time flies like an arrow.*

This sentence might mean that time seems to move quickly, just like an arrow moves quickly. That's probably how you interpreted it when you read it. But note that the word *time* can also be a verb, such as when you

**Voiceprint** The plot of frequency changes over time representing the sound of human speech

**Lexical ambiguity** The ambiguity created when words have multiple meanings

### Early Promise of Machine Translation Not Realized

Early machine translation efforts did not go smoothly. One failed attempt using bilingual dictionaries and word-by-word substitution translated the English expression "The spirit is willing, but the flesh is weak" into Russian as "The vodka is acceptable, but the meat is spoiled."

**Syntactic ambiguity**

The ambiguity created when sentences can be constructed in various ways

**Referential ambiguity**

The ambiguity created when pronouns could be applied to multiple objects

time the runner of a race. The word *flies* can also be a noun. Therefore, you could interpret this sentence as a directive to time flies in the same manner in which an arrow times flies. Because an arrow doesn't time things, you probably wouldn't apply that interpretation. But it is no less valid than the other one! Given the definition of the words, a computer would not necessarily know which interpretation was appropriate. We could even interpret this sentence a third way, indicating the preferences of that rare species we'll call a "time fly." After all, fruit flies like a banana. That interpretation probably sounds ridiculous to you, but such ambiguities cause huge problems when it comes to a computer understanding natural language.

A natural-language sentence can also have a **syntactic ambiguity** because phrases can be put together in various ways. For example:

*I saw the Grand Canyon flying to New York.*

Because canyons don't fly, there is one obvious interpretation. But because the sentence can be constructed that way, there are two valid interpretations. To reach the desired conclusion, a computer would have to "know" that canyons don't fly and take that fact into account.

**Referential ambiguity** can occur with the use of pronouns. Consider the following:

*The brick fell on the computer but it is not broken.*

What is not broken, the brick or the computer? We might assume the pronoun "it" refers to the computer in this case, but that is not necessarily the correct interpretation. In fact, if a vase had fallen on the computer, even we humans wouldn't know what "it" referred to without more information.

Natural-language comprehension is a huge area of study and goes well beyond the scope of this book, but it's important to understand the reasons why this issue is so challenging.

## 13.6 Robotics

Robots are familiar to all of us. From television commercials about robotic dogs to the nightly news about space exploration to assembly lines producing beer, cars, or widgets, robots are a part of modern society. *Robotics*—the study of robots—breaks down into two main categories: *fixed* robots and *mobile* robots. Fixed robots are what you see on assembly lines. The machines stay put and the products move. Because the world of a fixed robot is circumscribed, its tasks can be built into the hardware. Thus fixed robots belong

mostly in the area of industrial engineering. Mobile robots, by contrast, move about and must interact with their environment. Modeling the world of the mobile robot requires the techniques of artificial intelligence.

## The Sense–Plan–Act Paradigm

*Mobile robotics* is the study of robots that move relative to their environment, while exhibiting a degree of autonomy. The original approach to modeling the world surrounding a mobile robot made use of *plans*. Planning systems are large software systems that, given a goal, a starting position, and an ending situation, can generate a finite set of actions (a plan) that, if followed (usually by a human), brings about the desired ending situation. These planning systems solve general problems by incorporating large amounts of domain knowledge. In the case of a mobile robot, the domain knowledge is the input from the robot's sensors. In this approach, the world of the robot is represented in a complex semantic net in which the sensors on the robot capture the data used to build up the net. Populating the net is time consuming even for simple sensors; if the sensor is a camera, the process is *very* time consuming. This approach is called the *sense–plan–act (SPA) paradigm*<sup>2</sup> and is shown in [FIGURE 13.9](#).

The sensor data are interpreted by the world model, which in turn generates a plan of action. The robot's control system (the hardware) executes the steps in the plan. Once the robot moves, its sensors get new data, and the cycle repeats with the new data being incorporated into the semantic net. Problems occur when the new sensory data cannot be processed fast enough to be used. (Perhaps the robot falls into a hole before the world model recognizes that the change in light is a hole rather than a shadow.) The flaw in this approach is that the representation of the robot's world as domain knowledge in a general system is too general, too broad, and not tailored to the robot's task.

## Subsumption Architecture

In 1986, a paradigm shift occurred within the robotics community with Brooks's introduction of *subsumption architecture*.<sup>3</sup> Rather than trying to model the entire world all the time, the robot is given a simple set of



**FIGURE 13.9** The sense–plan–act (SPA) paradigm

### Robotic whiskers

Researchers have developed robots that can sense the environment in 3D by studying whiskers in nature, especially the whiskers of the rat. Using their whiskers, rats are able to gather three coordinates—similar to latitude, longitude, and elevation—to discern the 3D contours of an object. Researchers have built robots that successfully produce 3D images of a human face using data acquired from steel-wire whiskers tied to strain gauges.

© Artur Debat/Getty Images; © Alan Dyer/Stocktrek Images/Getty Images

## ELIZA

ELIZA was an early natural-language program. In the following script, the program plays the role of a neutral psychotherapist. The computer's responses are in all uppercase.

Men are all alike.

IN WHAT WAY?

They're always bugging us about something or another.

CAN YOU THINK OF A SPECIFIC EXAMPLE?

Well, my boyfriend made me come here.

YOUR BOYFRIEND MADE YOU COME HERE?

He says I'm depressed much of the time.

I AM SORRY TO HEAR YOU ARE DEPRESSED.

It's true. I am unhappy.

DO YOU THINK COMING HERE WILL HELP YOU NOT TO BE UNHAPPY?

I need some help, that much seems certain.

...

WHAT ELSE COMES TO MIND WHEN YOU THINK OF YOUR FATHER?

Bullies.

DOES THAT HAVE ANYTHING TO DO WITH THE FACT THAT YOUR BOYFRIEND MADE YOU COME HERE?<sup>3</sup>

behaviors, each of which is associated with the part of the world necessary for that behavior. The behaviors run in parallel unless they come in conflict, in which case an ordering of the goals of the behaviors determines which behavior should be executed next. The idea that the goals of behaviors can be ordered, or that the goal of one behavior can be subsumed by another, led to the name of the architecture.

In the model shown in [FIGURE 13.10](#), *Keep going to the left (or right)* takes precedence over *Avoid obstacles* unless an object gets too close, in which case the *Avoid obstacles* behavior takes precedence. As a result of this approach, robots were built that could wander around a room for hours without running into objects or into moving people.

The three laws of robotics defined by Isaac Asimov fit neatly into this subsumption architecture.<sup>5</sup> See [FIGURE 13.11](#).

Another shift in robotics moved away from viewing the world as a uniform grid with each cell representing the same amount of real space and toward viewing the world as a topological map. Topological



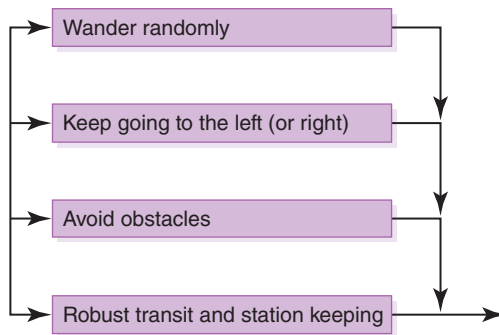


FIGURE 13.10 The new control paradigm

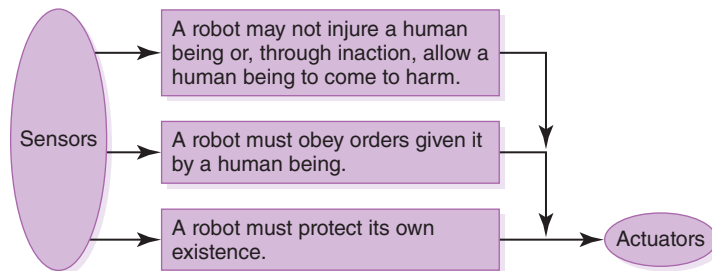


FIGURE 13.11 Asimov's laws of robotics are ordered

maps view space as a graph of places connected by arcs, giving the notion of proximity and order but not of distance. The robot navigates from place to place locally, which minimizes errors. Also, topological maps can be represented in memory much more efficiently than can uniform grids.

In the 1990s, a modified approach called *hybrid deliberate/reactive*, in which plans were used in conjunction with a set of behaviors with distributed worldviews, became popular.

## Physical Components

We have been discussing the various approaches to try to get a robot to exhibit humanlike behavior and have ignored the physical components of a robot. A robot is made up of sensors, actuators, and computational elements (a microprocessor). The sensors take in data about the surroundings, the actuators move the robot, and the computational elements send instructions to the actuators. Sensors are transducers that convert some physical phenomena into electrical signals that the microprocessor can read

### Into the wild red yonder

Think it's hard to hit a bull's eye with a dart or an arrow? Try sending a two-ton spacecraft 310 million miles to orbit around Mars. In March 2006, NASA's Mars Reconnaissance Orbiter began its orbit around Mars in what was hailed as a "picture-perfect" arrival just above the Martian atmosphere. The spacecraft sends data back to NASA from approximately 200 miles above the planet's surface. Its task is to find new landing sites for future missions.



## Chapter 13: Artificial Intelligence

?

### Fans mourn the passing of AIBO

Sadly, Sony Corporation announced the demise of AIBO, the robot dog that could learn its owner's name, show anger (eyes became red), and express happiness (eyes became green). More than 150,000 of these machines, which were the size of a toy poodle, were sold.

?

### NASA launches twin robots

In July 2003, NASA launched twin robots toward Mars. Since their safe arrival, *Spirit* and *Opportunity* have worked overtime to help scientists better understand the red planet's environment. The robots completed their original missions on Mars in April 2004 and continued to explore opposite sides of the planet through numerous mission extensions. *Spirit* stopped communicating with NASA in March of 2010, but as of January 2018, *Opportunity* was still sending data back to scientists on Earth and had traveled over 45 kilometers on the surface of Mars.



Courtesy of NASA/JPL-Caltech



© Chris Willson/Alamy Stock Photo



Courtesy of NASA/JPL-Caltech

?

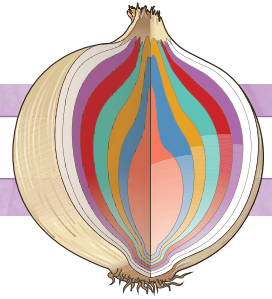
### What is the Sojourner rover?

The *Sojourner* was humanity's first attempt to operate a remote-control vehicle on another planet. After landing, *Sojourner* drove down one of the two ramps mounted to the lander petal. This exit and the subsequent exploration were watched by hundreds of millions of fascinated earth-bound viewers. The mission was conducted under the constraint of a once-per-sol (Martian day) opportunity for transmissions between the lander and earth operators. *Sojourner* was able to carry out her mission with a form of supervised autonomous control in which goal locations (called *waypoints*) or move commands were sent to the rover ahead of time, and *Sojourner* then navigated and safely traversed to these locations on her own.<sup>4</sup>

as data. Some sensors register the presence, absence, or intensity of light. Near-infrared proximity detectors, motion detectors, and force detectors can all be used as sensors. Cameras and microphones can be sensors. The three most common systems on which robots move are wheels, tracks, and legs.

© Artur Debat/Getty Images, © Alan Dyer/Stocktrek Images/Getty Images

## SUMMARY



Artificial intelligence deals with the attempts to model and apply the intelligence of the human mind. The Turing test is one measure to determine whether a machine can think like a human by mimicking human conversation.

The discipline of AI has numerous facets. Underlying all of them is the need to represent knowledge in a form that can be processed efficiently. A semantic network is a graphical representation that captures the relationships among objects in the real world. Questions can be answered based on an analysis of the network graph. Search trees are a valuable way to represent the knowledge of adversarial moves, such as in a competitive game. For complicated games like chess, search trees are enormous, so we still have to come up with strategies for efficient analysis of these structures.

An expert system embodies the knowledge of a human expert. It uses a set of rules to define the conditions under which certain conclusions can be drawn. It is useful in many types of decision-making processes, such as medical diagnosis.

Artificial neural networks mimic the processing of the neural networks of the human brain. An artificial neuron produces an output signal based on multiple input signals and the importance we assign to those signals via a weighting system. This mirrors the activity of the human neuron, in which synapses temper the input signals from one neuron to the next.

Natural-language processing deals with languages that humans use to communicate, such as English. Synthesizing a spoken voice can be accomplished by mimicking the phonemes of human speech or by replying with prerecorded words. Voice recognition is best accomplished when the spoken words are disjointed, and is even more effective when the system is trained to recognize a particular person's voiceprint. Comprehending natural language—that is, applying an interpretation to the conversational discourse—lies at the heart of natural-language processing.

It is complicated by various types of ambiguities that allow one specific sentence to be interpreted in multiple ways.

Robotics, the study of robots, focuses on two categories: fixed robots and mobile robots. Fixed robots stay put and have whatever they are working on come to them. Mobile robots are capable of moving and require the techniques of artificial intelligence to model the environment in which they navigate.



## ETHICAL ISSUES

### Initial Public Offerings<sup>6,7,8</sup>

What is an IPO? If you ever watch business news on television or read the business section in the paper, you probably know that IPO stands for *initial public offering*. An IPO marks the transition of a company from being privately held to being publicly held. Every incorporated business can issue stock to a small number of people. In order to raise a significant amount of money, the stock must be sold to the public.

To make an IPO, a company must register with the U.S. Securities and Exchange Commission (SEC) and prepare a public offering, which includes a prospectus and several legal documents. The prospectus includes anything and everything about the company—the good, the bad, and the bland.

Next, the company must contract with investment banks to underwrite or handle distribution of the shares to be sold. The company and its underwriters decide on an opening price based on earnings, potential earnings, and what they think the market will bear. The underwriters guarantee to the company that they will purchase all the shares at the opening price on the offering day, minus their firm's commission.

The underwriter then offers bundles of the stock to major brokerage firms, which in turn offer purchase rights to their big retail and institutional customers. Everyone takes

a markup in the process. So by the time the individual investor gets a chance at the stock, it has gone through several hands. If the stock is hot, the price will be above the initial offering price. If the stock is not hot, the price for investors may be lower than the initial price.

Prior to the Internet boom, companies needed strong financials and a solid history to go public. Many Internet companies that have gone public had never made a profit before their IPO and were not likely to in the near future; they had existed on venture capital. Two such companies were Facebook and Twitter. Facebook's IPO was overpriced, and early investors—those who bought shares at the offering price—saw their investment drop in value as the price dropped. Twitter's initial offering was underpriced, and early investors made a fortune as the stock rose immediately. These early investors were customers of banks involved in the underwriting of the IPO. Of course, both stocks later soared far above their initial offering value.

Is the process of allowing a company to go public without having demonstrated its ability to make a profit an ethical issue? It's proven both disastrous and immensely profitable for some investors. Is that a flaw in the system or just part of the risk involved in speculative investing?

## KEY TERMS

|                                |                       |
|--------------------------------|-----------------------|
| Artificial intelligence (AI)   | Phonemes              |
| Artificial neural network      | Referential ambiguity |
| Breadth-first approach         | Rule-based system     |
| Chatbot                        | Search tree           |
| Depth-first approach           | Semantic network      |
| Effective weight               | Strong equivalence    |
| Expert system                  | Syntactic ambiguity   |
| Inference engine               | Training              |
| Knowledge-based system         | Turing test           |
| Lexical ambiguity              | Voice recognition     |
| Loebner prize                  | Voice synthesis       |
| Natural language               | Voiceprint            |
| Natural-language comprehension | Weak equivalence      |

## EXERCISES

For Exercises 1–5, match the type of ambiguity with an example.

- A. Lexical
  - B. Referential
  - C. Syntactic
1. “Stand up for your flag.”
  2. “Go down the street on the left.”
  3. “He drove the car over the lawn mower, but it wasn’t hurt.”
  4. “I saw the movie flying to Houston.”
  5. “Mary and Kay were playing until she came inside.”

For Exercises 6–21, mark the answers true or false as follows:

- A. True
  - B. False
6. A computer does some tasks much better than a human being.
  7. A human being does some tasks much better than a computer.
  8. A computer system that can pass the Turing test is considered to be intelligent.
  9. Some AI researchers don’t think we can achieve true artificial intelligence until a computer processes information in the same way the human mind does.
  10. A semantic network is used to model relationships.
  11. If information is stored in a semantic network, it is easy to answer questions about it.

**EXERCISES (CONTINUED)**

12. A computer has never beaten a human at chess in master-level play.
13. An inference engine is part of a rule-based expert system.
14. A biological neuron accepts a single input signal and produces multiple output signals.
15. Each element in an artificial neural network is affected by a numeric weight.
16. Voice synthesis is the most difficult part of natural-language processing.
17. Each human has a unique voiceprint that can be used to train voice recognition systems.
18. The word *light* can be interpreted in many ways by a computer.
19. Syntactic ambiguity is no longer a problem for natural-language comprehension.
20. A robot may follow the sense–plan–act paradigm to control its movements.
21. Isaac Asimov created three fundamental laws of robotics.
24. Interpret a poem
25. Match a fingerprint
26. Paint a landscape
27. Carry on a conversation
28. Learn to speak
29. Judge guilt or innocence
30. Give affection

For Exercises 22–30, match the task with who can solve it most easily.

- A. Computer
- B. Human
22. Identify a dog in a picture
23. Add a column of 100 four-digit numbers
31. What is the Turing test?
32. How is the Turing test organized and administered?
33. What is weak equivalence, and how does it apply to the Turing test?
34. What is strong equivalence?
35. What is the Loebner prize?
36. Name and briefly describe five issues in the world of AI covered in this chapter.
37. Name and define two knowledge-representation techniques.
38. Which data structure defined in Chapter 8 is used to represent a semantic network?
39. Create a semantic network for the relationships among your family members. List five questions that your semantic network could easily be used to answer and five questions that would be more of a challenge to answer.

**EXERCISES (CONTINUED)**

40. Create a semantic network that captures the information in a small section of a newspaper article.
41. Which object-oriented properties do semantic networks borrow?
42. What is a search tree?
43. Why are trees for complex games like chess too large?
44. Distinguish between depth-first searching and breadth-first searching.
45. What does it mean to “prune a tree”?
46. Distinguish between knowledge-based systems and expert systems.
47. Distinguish between rule-based systems and inference engines.
48. What is an example of a human expert system?
49. What do we call a knowledge-based system that models the expertise of professionals in the field?
50. Why is an expert system called a *rule-based system*?
51. Which part of the software in an expert system determines how the rules are followed and what conclusions can be drawn?
52. How are the rules expressed in an expert system?
53. What are the advantages of an expert system?
54. What do we call a single cell that conducts a chemically based electronic signal?
55. What do a series of connected neurons form?
56. Upon what does the signal along a particular pathway depend?
57. What are the multiple input tentacles in a biological neuron?
58. What is the primary output tentacle in a biological neuron?
59. From where do dendrites of one neuron pick up the signals from other neurons to form a network?
60. What do we call the gap between an axon and a dendrite?
61. What tempers the strength of a synapse?
62. What is the role of a synapse?
63. How is a synapse modeled in an artificial neural network?
64. What is an effective weight in an artificial neuron?
65. How is the output value from an artificial neuron calculated?
66. If the processing element in an artificial neural net accepted five input signals with values of 0, 0, 1, 1, and 0 and corresponding weights of 5, -2, 3, 3, and 6, what is the output if the threshold is 5?

**EXERCISES (CONTINUED)**

67. If the processing element in an artificial neural net accepted five input signals with values of 0, 0, 1, 1, and 0 and corresponding weights of 5, -2, 3, 3, and 6, what is the output if the threshold is 7?
68. What is a phoneme?
69. Describe the two distinct ways that voice synthesis can be accomplished.
70. Which issues affect the ability to recognize the words spoken by a human voice?
71. How can a voice recognition system be trained?
72. Why are personalized voice-recognition systems so much better than generic systems?
73. Name and describe two categories of robots.
74. What are planning systems?
75. What defines subsumption architecture?
76. Of what is a robot composed?

**THOUGHT QUESTIONS**

1. Think of five questions that you might issue as the interrogator of a Turing test. Why would a computer have difficulty answering them well?
2. Do you think that strong equivalence is possible? How could it be proven?
3. When you think of robots, what comes to mind? Do you see a human-like machine scampering around the floor? An assembly line producing cars?
4. Had you ever heard of an IPO before reading this chapter? Have you ever invested in one?
5. Have you read about a new Internet company IPO in the news lately? If so, did you think its price seemed high, low, or about right?
6. The IPOs of Facebook and Twitter varied dramatically. What could have caused one to be overpriced and one underpriced?



## Laying the Groundwork

- 1 The Big Picture

## The Information Layer

- 2 Binary Values and Number Systems
- 3 Data Representation

## The Hardware Layer

- 4 Gates and Circuits
- 5 Computing Components

## The Programming Layer

- 6 Low-Level Programming Languages and Pseudocode
- 7 Problem Solving and Algorithms
- 8 Abstract Data Types and Subprograms
- 9 Object-Oriented Design and High-Level Programming Languages

## The Operating Systems Layer

- 10 Operating Systems
- 11 File Systems and Directories

## The Applications Layer

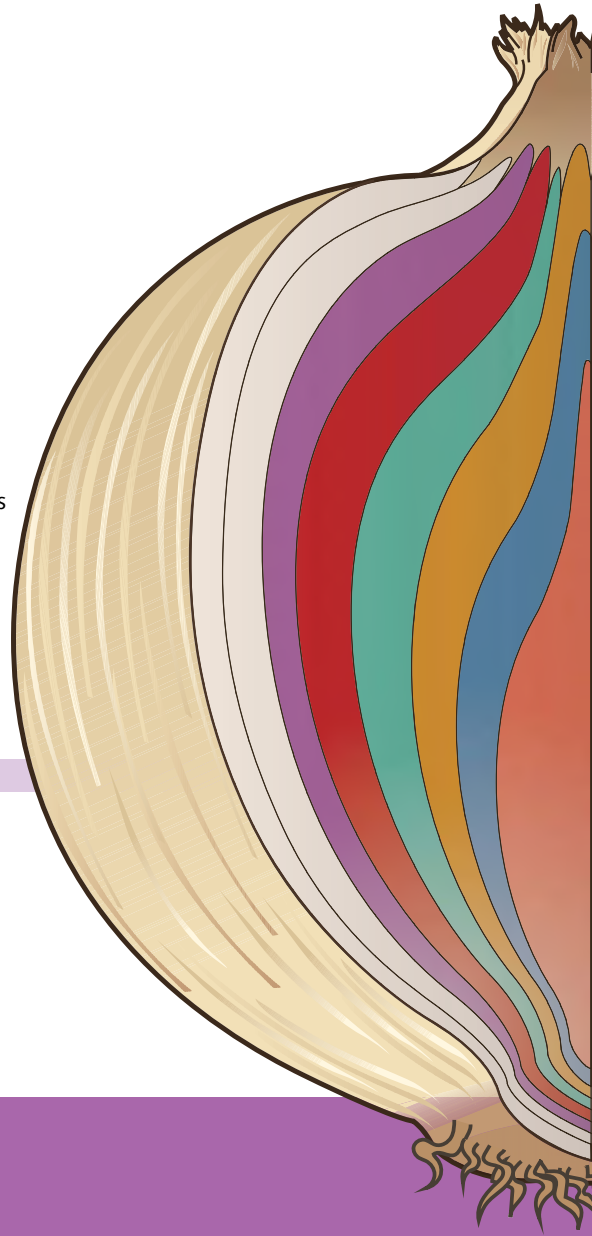
- 12 Information Systems
- 13 Artificial Intelligence
- 14 Simulation, Graphics, Gaming, and Other Applications

## The Communications Layer

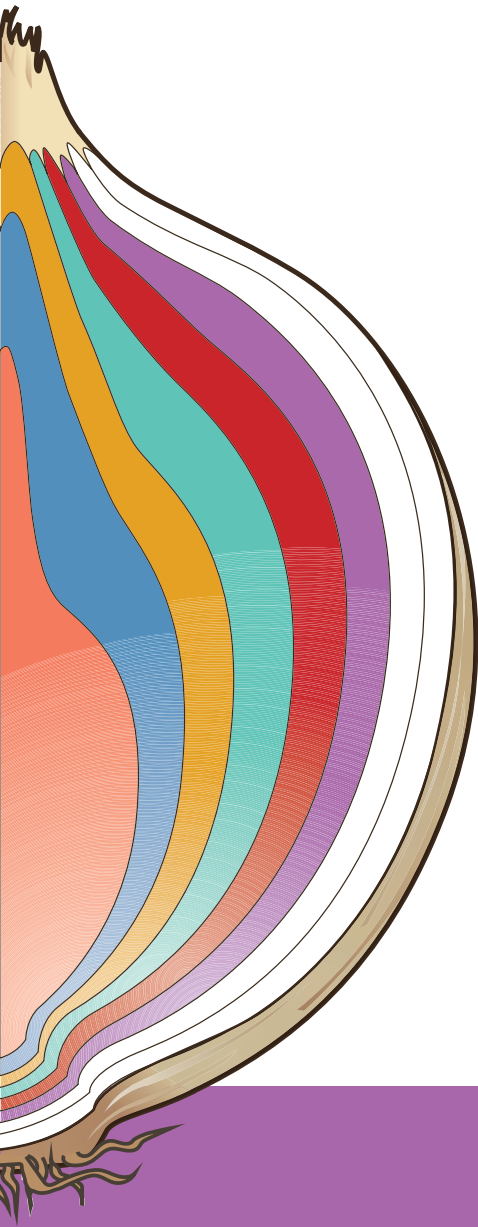
- 15 Networks
- 16 The World Wide Web
- 17 Computer Security

## In Conclusion

- 18 Limitations of Computing



# THE APPLICATIONS LAYER



# SIMULATION, GRAPHICS, GAMING, AND OTHER APPLICATIONS

14

The technique of using a model to represent phenomena, objects, or situations is called *simulation*. Airplane manufacturers build wind tunnels to study airflow around an airfoil on a new aircraft design. Pilots spend countless hours in a flight simulator, a model that recreates the responses of an aircraft to actions the pilot might take, thus allowing a pilot to learn to control the aircraft before he or she ever gets into the cockpit of a real plane. Before the plans of a new supermarket are finalized, a computer program is run to help determine how many checkout stations are needed for the expected number of customers.

In this chapter, we look at the theory behind simulations and examine some concrete examples, including models that predict the weather. Then we cover three other application types—computer graphics, computational biology, and gaming—to round out the discussion of the applications layer.

## GOALS

After studying this chapter, you should be able to:

- define *simulation*.
- give examples of complex systems.
- distinguish between continuous and discrete event simulation.
- explain how object-oriented design principles can be used in building models.
- name and discuss the four parts of a queuing system.
- explain the complexity of weather and seismic models.
- describe the important issues in graphics image generation.
- explain the additional concerns for animation versus single images.

## 14.1 What Is Simulation?

### Simulation

Developing a model of a complex system and experimenting with the model to observe the results

A simulation is a powerful tool used to study complex systems. **Simulation** is the development of a *model* of a *complex system* and the experimental manipulation of that model to observe the results. Models may be purely physical, such as a wind tunnel; a combination of physical objects under software control, such as a spaceship or flight simulator; or logical, as represented in a computer program.

Computer simulations have been used to help in decision making since the mid-1950s. Building computer models of complex systems has allowed decision makers to develop an understanding of the performance of the systems over time. How many tellers should a bank have? Would the materials flow faster through the manufacturing line if there were more space between stations? What is the weather going to be tomorrow? Where is the optimal place to put the new fire station? We can gain considerable insight into all of these questions through simulation.

### Complex Systems

*System* is one of those words that we all intuitively understand but have difficulty defining. The dictionary gives several definitions with the common theme of groups (collections) of objects interacting in some way. The objects can be animate or inanimate. A collection of hardware and software form a computer system. A collection of tracks and railway cars form a railroad system. A collection of teachers and students form a school system.

Systems that are best suited to being simulated are *dynamic*, *interactive*, and *complicated*.<sup>1</sup> That is, they should be complex. The behaviors of dynamic systems vary over time. The way that the behavior varies may be understood and captured in mathematical equations, such as the flight of a missile through nonturbulent atmosphere. Alternatively, the behavior may be only partially understood but amenable to statistical representation, such as the arrival of people at a traffic light. Although the definition of systems implies that the objects interact, the more interactions that exist in the system, the better a candidate the system is for simulation. Take, for example, the behavior of a plane under air traffic control. The performance characteristics of the individual plane, the interaction with the air traffic controller, the weather, and any routing changes due to problems on the ground all contribute to the plane's behavior. Finally, the system should be made up of many objects. If it weren't, simulating it would be a waste of time.

## Models

*Model* is another of those words that we all understand but might have a difficult time defining. There are two dictionary definitions that relate to the use of the word in simulation: an analogy used to help visualize something that cannot be directly observed; and a set of postulates, data, and inferences presented as a mathematical description of an entity or state of affairs. Although these two definitions seem very different, they share one major thread: In both cases, a model is an abstraction of something else. In the first case, the model represents something that is not completely understood, so we are forced to say it is like something else. In the second case, the system is understood well enough to be described by a set of mathematical rules.

For our purposes, a **model** is an abstraction of a real system. It is a representation of the objects within the system and the rules that govern the interactions of those objects. The representation may be concrete, as in the case of the spaceship or flight simulator, or it may be abstract, as in the case of the computer program that examines the number of checkout stations needed. In the rest of the discussion of simulation, the models we refer to are abstract. Their realization comes only within a computer program.

**Model** An abstraction of a real system; a representation of objects within a system and the rules that govern the behavior of the objects

## Constructing Models

The essence of constructing a model is to identify a small subset of characteristics or features that are sufficient to describe the behavior under investigation. Remember, a model is an abstraction of a real system; it is not the system itself. Therefore, there is a fine line between having too few characteristics to accurately describe the behavior of the system and having more characteristics than you need to accurately describe the system. The goal is to build the simplest model that describes the relevant behavior.

Models are built for two distinct types of simulation, and the process of choosing the subset of characteristics or features is different for each. The distinction between the two types is based on how time is represented: as a continuous variable or as a discrete event.

## Continuous Simulation

Continuous simulations treat time as continuous and express changes in terms of a set of differential equations that reflect the relationships among the set of characteristics. Thus the characteristics or features chosen to

model the system must be those whose behavior is understood mathematically. For example, meteorological modeling falls into this category. The characteristics of weather models are wind components, temperature, water vapor, cloud formation, precipitation, and so on. The interactions of these components over time can be modeled by a set of partial differential equations, which measure the rate of change of each component over some three-dimensional region.

Because of the technical nature of the characteristics in continuous simulations, engineers and economists frequently use this technique. The sets of possible characteristics and their interactions are well known in these fields. In a later section we look more closely at meteorological simulation.

### Discrete-Event Simulation

Discrete-event models are made up of *entities*, *attributes*, and *events*. An entity represents some object in the real system that must be explicitly defined. That is, the characteristic or feature of the system is an object. For example, if we were modeling a manufacturing plant, the different machines and the product being created would be entities. An attribute is some characteristic of a particular entity. The identification number, the purchase date, and the maintenance history would be attributes of a particular machine. An event is an interaction between entities. For example, sending the output from one machine as input to the next machine would be an event.

An object that flows through a system is usually represented as an entity. For example, the output from one machine is an object that is passed on to the next machine. Thus a raw widget flows from one machine to another (a series of events) and ends up as a lovely doodad. An entity can also represent a resource that other entities need. For example, a teller is a resource in a model of a bank. If a teller is not available, the customer entity must enter a waiting line (a queue) until a teller is available.

The keys to constructing a good model are choosing the entities to represent the system and correctly determining the rules that define the results of the events. Pareto's law says that in every set of entities, there exist a vital few and a trivial many. Approximately 80% of the behavior of an average system can be explained by the action of 20% of the components.<sup>2</sup> The second part of the definition of simulation gives us a clue where to begin: "experimental manipulation of that model to observe the results." Which results are to be observed? The answers to this question give a good starting point to the determination of the entities in the real

system that must be present in the model. The entities and the rules that define the interactions of the entities must be sufficient to produce the results to be observed.

Because a computer program implements an abstract model, we can apply object-oriented design to the problem of building the model. The entities in the model are object classes. The attributes of the entities are properties of a class. Where do the events fall into this analogy? The events are the responsibilities of an entity. The rules that define the interactions of the entities in the system are represented by the collaborations of the classes.

## 14.2 Specific Models

In this section, we examine three types of simulation models.

### Queuing Systems

Let's look at a very useful type of simulation called a *queuing system*. A queuing system is a discrete-event model that uses random numbers to represent the arrival and duration of events. A queuing system is made up of servers and queues of objects to be served. Recall from Chapter 8 that a queue is a first-in, first-out (FIFO) structure. We deal with queuing systems all the time in our daily lives. When you stand in line to check out at the grocery store or to cash a check at the bank, you are dealing with a queuing system. When you submit a "batch job" (such as a compilation) on a mainframe computer, your job must wait in line until the CPU finishes the jobs scheduled ahead of it. When you make a phone call to reserve an airline ticket and get a recording ("Thank you for calling Air Busters; your call will be answered by the next available operator"), you are dealing with a queuing system.

### Please Wait

Waiting is the critical element. The objective of a queuing system is to utilize the servers (the tellers, checkers, CPU, operators, and so on) as fully as possible while keeping the wait time within a reasonable limit. These goals usually require a compromise between cost and customer satisfaction.

To put this on a personal level, no one likes to stand in line. If there were one checkout counter for each customer in a supermarket, the customers would be delighted. The supermarket, however, would not be in business very long. So a compromise is made: The number of cashiers is

kept within the limits set by the store's budget, and the average customer is not kept waiting *too* long.

How does a company determine the optimal compromise between the number of servers and the wait time? One way is by experience—the company tries out different numbers of servers and sees how things work out. There are two problems with this approach: It takes too long and it is too expensive. Another way of examining this problem is to use a computer simulation.

To construct a queuing model, we must know the following four things:

1. The number of events and how they affect the system so we can determine the rules of entity interaction
2. The number of servers
3. The distribution of arrival times so we can determine if an entity enters the system
4. The expected service time so we can determine the duration of an event

The simulation uses these characteristics to predict the average wait time. The number of servers, the distribution of arrival times, and the duration of service can be changed. The average wait times are then examined to determine what a reasonable compromise would be.

### An Example

Consider the case of a drive-through bank with one teller. How long does the average car have to wait? If business gets better and cars start to arrive more frequently, what would be the effect on the average wait time? When would the bank need to open a second drive-through window?

This problem has the characteristics of a queuing model. The entities are a *server* (the teller), the *objects being served* (the customers in cars), and a queue to hold the objects waiting to be served (customers in cars). The *average wait time* is what we are interested in observing. The events in this system are the arrivals and the departures of customers.

Let's look at how we can solve this problem as a time-driven simulation. A *time-driven simulation* is one in which the model is viewed at uniform time intervals—say, every minute. To simulate the passing of a unit of time (a minute, for example), we increment a clock. We run the simulation for a predetermined amount of time—say, 100 minutes.



#### SIMULA is designed for simulation

The SIMULA programming language, designed and built by Ole-Johan Dahl and Kristen Nygaard at the Norwegian Computing Centre (NCC) in Oslo between 1962 and 1967, was intended to be a language for discrete-event simulation. SIMULA was later expanded and reimplemented as a full-scale, general-purpose programming language. Although SIMULA was never widely used, the language has greatly influenced modern programming methodology. SIMULA introduced such important object-oriented language constructs as classes and objects, inheritance, and polymorphism.<sup>3</sup>

(Of course, simulated time usually passes much more quickly than real time; 100 simulated minutes passes in a flash on the computer.)

Think of the simulation as a big loop that executes a set of rules for each value of the clock—from 1 to 100, in our example. Here are the rules that are processed in the loop body:

Rule 1. If a customer arrives, he or she gets in line.

Rule 2. If the teller is free and if there is anyone waiting, the first customer in line leaves the line and advances to the teller's window. The service time is set for that customer.

Rule 3. If a customer is at the teller's window, the time remaining for that customer to be serviced is decremented.

Rule 4. If there are customers in line, the additional minute that they have remained in the queue (their wait time) is recorded.

The output from the simulation is the average wait time. We calculate this value using the following formula:

Average wait time = total wait time for all customers  $\div$  number of customers

Given this output, the bank can see whether its customers have an unreasonable wait in a one-teller system. If so, the bank can repeat the simulation with two tellers.

Not so fast! There are still two unanswered questions. How do we know if a customer arrived? How do we know when a customer has finished being serviced? We must provide the simulation with data about the arrival times and the service times, both of which are variables (parameters) in the simulation. We can never predict exactly when a customer will arrive or how long each individual customer will take. We can, however, make educated guesses, such as a customer arrives about every five minutes and most customers take about three minutes to service.

How do we know whether a job has arrived in this particular clock unit? The answer is a function of two factors: the number of minutes between arrivals (five in this case) and chance. *Chance?* Queuing models are based on chance? Well, not exactly. Let's express the number of minutes between arrivals another way—as the *probability* that a job arrives in any given clock unit. Probabilities range from 0.0 (no chance) to 1.0 (a sure thing). If on average a new job arrives every five minutes, then the chance of a customer arriving in any given minute is 0.2



(1 chance in 5). Therefore, the probability of a new customer arriving in a particular minute is 1.0 divided by the number of minutes between arrivals.

Now what about luck? In computer terms, luck can be represented by the use of a *random-number generator*. We simulate the arrival of a customer by writing a function that generates a random number between 0.0 and 1.0 and applies the following rules:

1. If the random number is between 0.0 and the arrival probability, a job has arrived.
2. If the random number is greater than the arrival probability, no job arrived in this clock unit.

By changing the rate of arrival, we simulate what happens with a one-teller system where each transaction takes about three minutes as more and more cars arrive. We can also have the duration of service time based on probability. For example, we could simulate a situation where 60% of the people require three minutes, 30% of the people require five minutes, and 10% of the people require ten minutes.

Simulation doesn't give us *the* answer or even *an* answer. Simulation is a technique for trying out "what if" questions. We build the model and run the simulation many times, trying various combinations of the parameters and observing the average wait time. What happens if the cars arrive more quickly? What happens if the service time is reduced by 10%? What happens if we add a second teller?

### Other Types of Queues

The queue in the previous example was a FIFO queue: The entity that receives service is the entity that has been in the queue the longest time. Another type of queue is a *priority queue*. In a priority queue, each item in the queue is associated with a priority. When an item is dequeued, the item returned is the one with the highest priority. A priority queue operates like triage in the medical field. When multiple injured or ill people arrive at the same time, the doctors determine the severity of each person's injuries. Those with the most severe problems get treated first.

Another scheme for ordering events is to have two FIFO queues: one for short service times and one for longer service times. This scheme is similar to the express lane at the supermarket. If you have fewer than ten items, you can go into the queue for the express lane; otherwise, you must enter the queue for one of the regular lanes.

## Meteorological Models

In the last section we looked at a fairly simple simulation with discrete inputs and outputs. We now jump to a discussion of a continuous simulation: predicting the weather. The details of weather prediction are over the heads of all but professional meteorologists. In general, meteorological models are based on the time-dependent partial differential equations of fluid mechanics and thermodynamics. Equations exist for horizontal wind velocity components, the vertical velocity, temperature, pressure, and water vapor concentration. A few such equations are shown in [FIGURE 14.1](#). Don't worry, working with these equations is beyond the scope of this book—we just want to convey some of the complex processing that occurs in these types of models.

To predict the weather, initial values for the variables are entered from observation, and then the equations are solved to identify the values of the variables at some later time.<sup>4</sup> These results are then reintegrated using the predicted values as the initial conditions. This process of reintegrating using the predicted values from that last integration as the observed values for the current integration continues, giving the predictions over time. Because these equations describe rates of change of entities in the model, the answers after each solution give values that can be used to predict the next set of values.

Pressure:

$$\begin{aligned} \frac{\partial p^* p'}{\partial t} = & -m^2 \left[ \frac{\partial p^* u p' / m}{\partial x} + \frac{\partial p^* v p' / m}{\partial y} \right] - \frac{\partial p^* p' \sigma}{\partial \sigma} + p' DIV \\ & - m^2 p^* \gamma p \left[ \frac{\partial u / m}{\partial x} - \frac{\sigma}{m p^*} \frac{\partial p^*}{\partial x} \frac{\partial u}{\partial \sigma} + \frac{\partial v / m}{\partial y} - \frac{\sigma}{m p^*} \frac{\partial p^*}{\partial y} \frac{\partial v}{\partial \sigma} \right] \\ & + p_0 g \gamma p \frac{\partial w}{\partial \sigma} + p^* p_{0g w} \end{aligned}$$

Temperature:

$$\begin{aligned} \frac{\partial p^* T}{\partial t} = & -m^2 \left[ \frac{\partial p^* u T / m}{\partial x} + \frac{\partial p^* v T / m}{\partial y} \right] - \frac{\partial p^* T \sigma}{\partial \sigma} + T DIV \\ & + \frac{1}{\rho c_p} \left[ p^* \frac{Dp'}{Dt} - p_0 g p^* w - Dp' \right] + p^* \frac{Q}{c_p} + DT, \end{aligned}$$

where

$$DIV = m^2 \left[ \frac{\partial p^* u / m}{\partial x} + \frac{\partial p^* v / m}{\partial y} \right] + \frac{\partial p^* \sigma}{\partial \sigma},$$

and

$$\sigma = -\frac{p_0 g}{p^*} w - \frac{m \sigma}{p^*} \frac{\partial p^*}{\partial x} u - \frac{m \sigma}{p^*} \frac{\partial p^*}{\partial y} v.$$

**FIGURE 14.1** Some of the complex equations used in meteorological models

© Artur Debat/Getty Images; © Alan Dyer/Stocktrek Images/Getty Images

## Ivan Sutherland

Ivan Sutherland has credentials in academia, industrial research, and business. On his website, Sutherland lists his profession as “engineer, entrepreneur, capitalist, professor.” He has won the ACM’s prestigious Turing Award, the Smithsonian Computer World Award, the First Zwoykin Award from the National Academy of Engineering, and the Price Waterhouse Information Technology Leadership Award for Lifetime Achievement.

Sutherland received a BS from Carnegie Institute of Technology, an MS from the California Institute of Technology, and a PhD from the Massachusetts Institute of Technology. His PhD thesis, “Sketchpad: A Man–Machine Graphical Communications System,” pioneered the use of the light pen to create graphic images directly on a display screen. The graphic patterns could be stored in memory and later retrieved and manipulated just like any other data. Sketchpad was the first graphical user interface (GUI), arriving on the scene long before the term was invented; it opened up the field of computer-aided design (CAD).

The U.S. Department of Defense and the National Security Agency (NSA) spearheaded computing research in the early 1960s. When Sutherland graduated, he was inducted into the Army and assigned to the NSA. In 1964, he was transferred to the Defense Department’s Advanced Research Projects Agency (ARPA, later DARPA), where he commissioned and managed computer science research projects as director of ARPA’s Information Processing Techniques Office. After his stint with

the military, Sutherland went to Harvard as an associate professor. Sketchpad, which allowed people to interact with the computer in terms of images, was the logical predecessor to Sutherland’s work in virtual reality. His goal was the “ultimate display,” which would include a full-color, stereoscopic display that filled the user’s entire field of vision. Turning the theory into practice was more difficult than first imagined because of the weight of the head-mounted display (HMD). In fact, the first implementation was mounted on the wall or ceiling rather than the head, earning it the nickname “Sword of Damocles.”

In 1968, Sutherland moved to the University of Utah, where he continued his research into HMD systems. Sutherland and David Evans, another faculty member at Utah, founded Evans & Sutherland, a company specializing in hardware and software for visual systems for simulation, training, and virtual reality applications. In 1975, Sutherland returned to the California Institute of Technology as chairman of the Computer Sciences department, where he helped to introduce circuit design into the curriculum.

Sutherland left Caltech in 1980 and established Sutherland, Sproull, and Associates, a consulting and venture capital firm. He later served as vice president and Sun Fellow at Sun Microsystems. He now holds eight patents in computer graphics and hardware and continues his research into hardware technology.



© Kenichiro Seki/Xinhua Press/Corbis

© Artur Debat/Getty Images; © Alan Dyer/Stocktrek Images/Getty Images

## Ivan Sutherland (continued)

Sutherland was awarded the Turing Award in 1988. The citation reads:

For his pioneering and visionary contributions to computer graphics, starting with Sketchpad, and continuing after. Sketchpad, though written twenty-five years ago, introduced many techniques still important today. These include a display file for screen refresh, a recursively traversed hierarchical structure for modeling graphical objects, recursive methods for geometric

transformations, and an object oriented programming style. Later innovations include a “Lorgnette” for viewing stereo or colored images, and elegant algorithms for registering digitized views, clipping polygons, and representing surfaces with hidden lines.

In 2012, Sutherland won the Kyoto Prize in Advanced Technology. Despite all the honors Sutherland has received, he once cited his proudest accomplishment as his four grandchildren.

These types of simulation models are computationally expensive. Given the complexity of the equations and the fact that they must hold true at each point in the atmosphere, high-speed parallel computers are needed to solve them in a reasonable amount of time.

## Weather Forecasting

“Red sky in the morning, sailor take warning” is an often-quoted weather prediction. Before the advent of computers, weather forecasting was based on folklore and observations. In the early 1950s, the first computer models were developed for weather forecasting. These models took the form of very complex sets of partial differential equations. As computers grew in size, the weather forecasting models grew even more complex.

If weathercasters use computer models to predict the weather, why are TV or radio weathercasts in the same city different? Why are they sometimes wrong? Computer models are designed to aid the weathercaster, not replace him or her. The outputs from the computer models are predictions of the values of variables in the future. It is up to the weathercaster to determine what the values *mean*.



### Tsunami detection

Tsunami experts are developing better ways to let people know when a tsunami is coming. Scientists are now using sensors laid on cables on the sea floor to detect the very light disturbance of a tsunami passing overhead on the ocean surface. When the sensors pick up a tsunami, a buoy anchored nearby sends the signal to land via satellite. The National Oceanic and Atmospheric Administration's (NOAA) Pacific Marine Environmental Laboratory (PMEL), based in Seattle, designed the deep ocean assessment and reporting of tsunami (DART) buoys. These systems are able to detect sea-level changes of less than a millimeter in the ocean.

Note that in the last paragraph we referred to multiple models. Different models exist because they make different assumptions. However, all computer models approximate the earth's surface and the atmosphere above the surface using evenly spaced grid points. The distance between these points determines the size of the grid boxes, or resolution. The larger the grid boxes, the poorer the model's resolution becomes. The Nested Grid model (NGM) has a horizontal resolution of 80 km and 18 vertical levels, and views the atmosphere as divided into squares for various levels of the atmosphere. Grids with smaller squares are nested inside larger ones to focus on particular geographic areas. The NGM forecasts 0–48 hours into the future every 6 hours.

The Model Output Statistics (MOS) model consists of a set of statistical equations tailored to various cities in the United States. The ETA model, named after the ETA coordinate system that takes topographical features such as mountains into account, is a newer model that closely resembles the NGM but has better resolution (29 km).<sup>5</sup> WRF is an extension of ETA, which uses a variable-size grid of 4 to 12.5, and 25 to 37 levels.

The output from weather models can be in text form or graphical form. The weathercaster's job is to interpret all of the output. But any good weathercaster knows that the output from any of these models is only as good as the input used as a starting point for the differential equations. This data comes from a variety of sources, including radiosondes (to measure humidity, temperature, and pressure at high altitudes), rawinsondes (to measure wind velocity aloft), aircraft observations, surface observations, satellites, and other remote sensing sources. A small error in any of the input variables can cause an increasing error in the values as the equations are reintegrated over time. Another problem is that of scale. The resolution of a model may be too coarse for the weathercaster to accurately interpret the results within his or her immediate area.

Different weathercasters may believe the predictions or may decide that other factors indicate that the predictions are in error. In addition, the various models may give conflicting results. It is up to the weathercaster to make a judgment as to which, if any, is correct.

## Hurricane Tracking

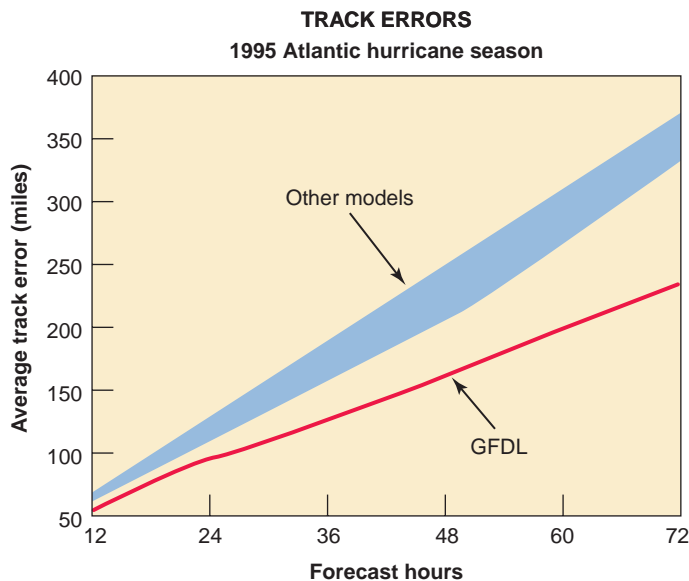
The modules for hurricane tracking are called *relocatable models*, because they are applied to a moving target. That is, the geographical location of the model's forecast varies from run to run (that is, from hurricane

to hurricane). The Geophysical and Fluid Dynamics Laboratory (GFDL) developed the most recent hurricane model in an effort to improve the prediction of where a hurricane would make landfall.

The GFDL hurricane model became operational in 1995. The equations were such that the forecasts couldn't be made fast enough to be useful until the National Weather Service's high-performance supercomputers were used in parallel operation, which increased the running time over the serial implementation by 18%. **FIGURE 14.2** shows the improvement of this model over the previous ones used to track hurricanes.

GFDL is being replaced by a specialized version of WRF, called *HWRF*. *HWRF* uses 27- and 9-km grid cells with 42 levels. It also takes information from a second simulation called the *Princeton Ocean Model*, which provides data on ocean currents and temperatures.

Some researchers are producing models that combine the outputs of other models. Such combined models, which have been called "superensembles," give better results than individual models. The longer this kind of model runs, the better its results are. In one study focusing on a forecast of hurricane winds three days into the future, a combined model had an



**FIGURE 14.2** Improvements in hurricane models

Reprinted, by permission, from the National Science and Technology Council, *High Performance Computing and Communications: Advancing the Frontiers of Information Technology*

**Saharan dust confuses hurricane predictions**

Each year, the United States' National Oceanic and Atmospheric Administration predicts the number of named storms and their severity. The prediction for 2013 was 13 storms, with 11 of them reaching hurricane strength. But 2013 turned out to be the fourth-quietest hurricane season in 70 years. What happened instead? More wind shear and blooms of Saharan dust occurred than expected. Even the best predictive models are only as good as their input.<sup>7</sup>

**Computational**

**biology** An interdisciplinary field that applies techniques of computer science, applied mathematics, and statistics to problems in biology

error of 21.5 mph as compared to the individual model errors that ranged from 31.3 mph to 32.4 mph.

**Specialized Models**

Meteorological models can be adapted and specialized for research purposes. For example, numeric-model simulations of atmospheric processes are being combined with air-chemistry models to diagnose atmospheric transport and diffusion for a variety of air-quality applications. One such study analyzed the part played by the topography of the Grand Canyon region of Arizona in the movement of air pollution.

Another study showed that by assimilating or ingesting observed data within the model solution as the model was running forward in time, rather than using observations at only the initial time, the model's performance increased significantly. This allows for improved numerical representations of the atmosphere for input into other specialized models.<sup>6</sup>

Advanced meteorological modeling systems can be used to provide guidance for other complex systems in the military or aviation industry. For example, the weather has an impact on projectile motions and must be taken into consideration in battlefield situations. In the aviation industry, meteorological data is used in diverse ways, from determining how much fuel to carry to deciding when to move planes to avoid hail damage.

**Computational Biology**

**Computational biology** is an interdisciplinary field that applies techniques of computer science, applied mathematics, and statistics to problems in biology. These techniques include model building, computer simulation, and graphics. Much biological research, including genetic/genomic research, is now conducted via computational techniques and modeling rather than in traditional “wet” laboratories with chemicals. Computational tools enabled genomic researchers to map the complete human genome by 2003; using traditional sequencing methods would have required many more years to accomplish this objective. Computational techniques have also assisted researchers in locating the genes for many diseases, which has resulted in pharmaceuticals being developed to treat and cure those diseases.

Computational biology encompasses numerous other fields, including the following:

- **Bioinformatics**, the application of information technology to molecular biology. It involves the acquisition, storage, manipulation, analyses, visualization, and sharing of biological information on computers and computer networks.



- **Computational biomodeling**, the building of computational models of biological systems.
- **Computational genomics**, the deciphering of genome sequences.
- **Molecular modeling**, the modeling of molecules.
- **Protein structure prediction**, the attempt to produce models of three-dimensional protein structures that have yet to be found experimentally.

## Other Models

In a sense, every computer program is a simulation, because a program represents the model of the solution that was designed in the problem-solving phase. When the program is executed, the model is simulated. We do not wish to go down this path, however, for this section would become infinite. There are, however, several disciplines that explicitly make use of simulation.

Will the stock market go higher? Will consumer prices rise? If we increase the money spent on advertising, will sales go up? Forecasting models help to answer these questions. However, these forecasting models are different from those used in weather forecasting. Weather models are based on factors whose interactions are mostly known and can be modeled using partial differential equations of fluid mechanics and thermodynamics. Business and economic forecasting models are based on past history of the variables involved, so they use regression analysis as the basis for prediction.

Seismic models depict the propagation of seismic waves through the earth's medium. These seismic waves can come from natural events, such as earthquakes and volcanic eruptions, or from human-made events, such as controlled explosions, reservoir-induced earthquakes, or cultural noise (industry or traffic). For natural events, sensors pick up the waves. Models, using these observations as input, can then determine the cause and magnitude of the source causing the waves. For human-made events, given the size of the event and the sensor data, models can map the earth's subsurface. Such models may be used to explore for oil and gas. The seismic data is used to provide geologists with highly detailed three-dimensional maps of hidden oil and gas reservoirs before drilling begins, thereby minimizing the possibility of drilling a dry well.

## Computing Power Necessary

Many of the equations necessary to construct the continuous models discussed here were developed many years ago. That is, the partial differential equations that defined the interactions of the entities in the model



were known. However, the models based on them could not be simulated in time for the answers to be useful. The introduction of parallel high-performance computing in the mid-1990s changed all that. Newer, bigger, faster machines allow scientists to solve more complex mathematical systems over larger domains and ever-finer grids with even shorter wall clock times. The new machines are able to solve the complex equations fast enough to provide timely answers. Numerical weather forecasting, unlike some other applications, must beat the clock. After all, yesterday's weather prediction is not very useful if it is not received until today.

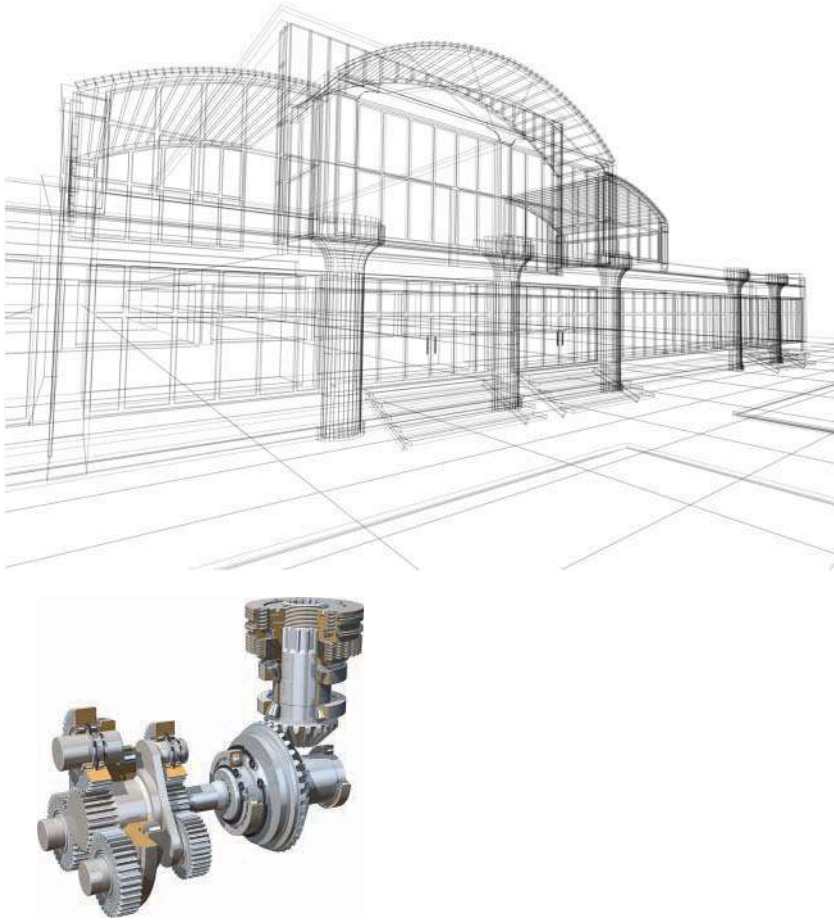
## 14.3 Computer Graphics

Computer graphics can be very generally described as the setting of pixel values on the computer screen. Recall that we talked about computer images in Chapter 3. At that time, we said that an image is a collection of pixel values specified as the red, green, and blue values. Although that earlier discussion referred to pictures we could scan and display on a computer screen, it also applies to everything we display on a computer screen.

The field of computer graphics plays a role in many aspects of computer science. The most common application is in the graphical user interface (GUI) of modern operating systems. Files and folders are represented as icons on the screen, with the icon indicating the file type. Interacting with the computer involves pointing, clicking, and dragging, which change the appearance of the screen. Computer graphics determines how to set the pixel colors to display the icons and how to change the pixel values as an icon is dragged across the screen.

Word processors and desktop publishing software are other applications of computer graphics. Their ability to show how the document will appear when printed is made possible by the way pixels are set on the screen. Although you might not think about black-and-white text on the screen when you think of computer graphics, it is still involved in the display. Illustrations in user's manuals are also generated with computer graphics. In this application, special techniques are used to produce images that highlight the feature or part being discussed instead of creating fully realistic images.

Companies also use computer graphics in the design and manufacturing of products. Computer-aided design (CAD) systems let engineers create the specification of new components using geometric modeling techniques (as in [FIGURE 14.3](#)). These parts can be displayed on the screen and can even be tested for stress points that could potentially break.



**FIGURE 14.3** Geometric modeling techniques

© Artyfree/Shutterstock; © Stephen Sweet/Shutterstock

These drawings can eventually be used to give instructions to assembly-line machines that create the parts.

Artists use computer graphics in many ways. Some artists use a computer as a high-tech canvas. Paint programs allow artists to create works using the computer instead of brushes and canvas. Image manipulation software allows photographers to touch up pictures or to combine multiple images to create unique effects. Artists also use the computer as an integral part of the artwork. For example, as far back as 1982, Jane Veeder created the WARPITOUT computer installation, which allowed users to take their pictures digitally and then manipulate them before they became part of a rotating gallery of recent images.

Scientific experimentation and simulations inevitably produce large amounts of data. A scientist who examines data as numbers on a page might miss a trend or pattern in those data. An alternative means of analysis is scientific visualization with data presented in a graphical format. Scientific visualization systems allow the user to change the colors associated with different values and create cross-sections through the data to help discover patterns or trends. A related application is in medical imaging. Results of tests using technologies such as computerized tomography (CT), ultrasound, and magnetic resonance imaging (MRI) are presented in a graphical form, which a doctor or technician can then use to make a diagnosis.

Even though numerous applications of computer graphics exist, it is likely that when you think about computer graphics, you imagine computer games, animated films, or special effects on television and movies. These are the most “fun” of the applications—but also the most complex. The complexity comes from the need to simulate very complex processes—the interaction of light and objects, modeling of the shapes of simple and complex objects, the natural movement of characters and objects. The rest of this section will look at some of these issues in more detail. As you will see, there are a lot of details in computer graphics, which makes it a complex as well as a fun area of study. Because computer graphics is broad enough to be the subject of entire textbooks, this section can merely give you a hint of what’s involved.

## How Light Works

The human visual system works because light reflects off objects and enters our eyes. The lens of the eye focuses the light as it strikes the back of the eye. The back of the eye is composed of cone and rod cells that react to the light that strikes them. The cone cells come in three varieties—long, middle, and short—based on the wavelength of light they react to. The long cones react to red shades; the middle cones react to green shades; and the short cones react to blue shades. The rod cells react only to the intensity of the light, so they lack color sensitivity. The reactions in the cone and rod cells are interpreted by our visual system and brain, which ensure that we see objects in front of us.

Light in our world strikes objects, reflecting off of them. Although we might think of mirrors and polished objects as being the only reflective ones, in reality all objects reflect light. The amount of light that is reflected depends on the amount of light available. On a sunny day, many more objects are visible than on a cloudy day or at a time late in the evening.

### ?

#### Communication through touch

Haptics is the field of science and technology dedicated to tactile sensation, meaning touch. Haptic devices simulate touch-related sensations such as pressure, temperature, and texture. Force-feedback steering wheels and joysticks are examples of simple haptic devices. Today, haptic devices are used as surgical-simulation tools to train doctors. Before such systems became available, trainee surgeons practiced on oranges! Advances in haptic technology have made it possible to explore how humans’ sense of touch works—a great advancement, especially in the field of robotics.

In addition to the amount of light, the appearance of an object is influenced by what the object is made of. For example, plastic, wood, and metal all look different because of their properties. Plastic objects have color particles embedded in them but they have very shiny surfaces. Highlights on plastic objects are the same color as the light, no matter what color the object is. Wood objects are influenced by the grains in the wood, which reflect light unevenly. Metal objects have microscopically rough surfaces, so they have highlights, albeit not as sharp as those on plastic.

Consider a flat mirror. The direction in which the mirror points can be specified by its normal vector ( $N$ ), which is perpendicular to the mirror surface (FIGURE 14.4). The angle that light reflects off the mirror ( $u$ ) will be the same relative to the normal vector as the angle from which the light arrives. If you are in the direction of a view vector ( $V$ ), what you see will be influenced by the directions of all of these vectors. The entire process is complex because light can strike the mirror from many different directions. When you look at yourself in a mirror, light reflects off your face and clothes from different directions before entering your eye.

Shadows are an important component of our world. They give us visual cues about the locations of objects and light sources. They also give us cues about the relative locations of two objects. If two objects are touching, for example, the shadow cast by one of the objects will be very close to that object. As the objects move apart, the shadow will change and, depending on the lighting conditions, could even disappear. This explains why some early hand-drawn cartoons seem odd: Some include shadows for the characters and some don't. Mickey Mouse casts a shadow but Fred Flintstone doesn't. The result is that

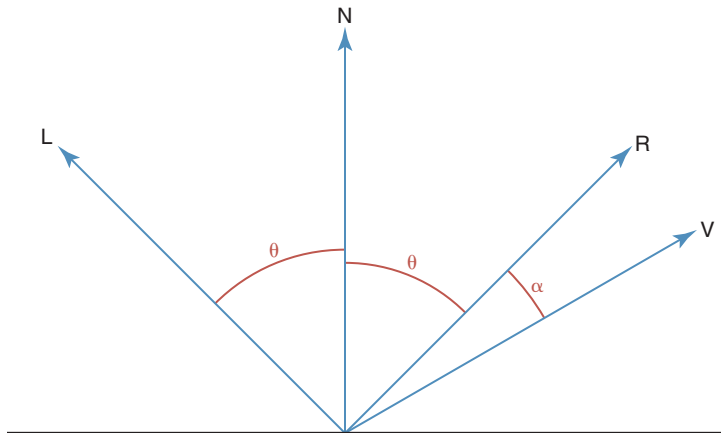


FIGURE 14.4 The normal ( $N$ ), light ( $L$ ), view ( $V$ ), and reflection ( $R$ ) vectors

Mickey seems to be walking on the ground, whereas Fred seems to be floating in air.

To produce realistic images, computer programs must do calculations that simulate the interaction between light and an object, the irregular surface of a textured object, and the change in light intensity in locations in shadows. These calculations can take a lot of time. Animated films and movie special effects look better than computer games because simplifications and shortcuts are needed so that a game can generate images in real time. Another important component of this process is the representation of the shape of objects in the image, which is discussed next.

## Object Shape Matters

The shape of an object also influences the appearance of the object. When an object is flat, like a mirror, there is one normal vector direction for every location on the object. If an object is not flat, the normal vector direction can be different at various locations. This change in normal vector direction alters the highlight shape, which gives us visual cues as to the shape of the object.

Recall from your math classes that we use equations to describe lines, planes, spheres, cylinders, and other objects. These equations are used in computer graphics to specify the shapes of objects. If you look around, you will see that objects have a wide variety of shapes. Many are much more complex than these simple mathematical objects. Computer graphics also offers ways to mathematically describe the shapes of curved surfaces. Complex objects are then defined by a collection of individual curves.

Even though objects in our world are solid, computer graphics deals only with the surface of objects, because that is all we see. Additionally, these mathematical equations define smooth surfaces, even though real objects may have irregular surfaces. For example, bricks and concrete have a rough surface that will scatter light differently than a smooth surface does. Graphics software uses texture mapping techniques to simulate these rough surfaces.

## Simulating Light

A number of techniques are used to simulate the interaction of light and objects in graphics. Some techniques are simple; others are very computationally complex. In general, the simulation of light interacting at

### ?

#### Where are Voyager 1 and 2 now?

The Voyager 1 and Voyager 2 space probes were launched in 1977. They encountered Jupiter in 1979 and Saturn in 1980 and 1981. Voyager 2 flew past Uranus in 1986 and reached Neptune in 1989. The probes are now exploring the space between the stars, and they will continue to do so until 2025, when their power will run out. As of March 2018, Voyager 1 was over 13 billion miles from the Earth, the furthest of any human-made object ever.<sup>8</sup>

one point on an object is called an *illumination model*, while the process of using an illumination model to determine the appearance of an entire object is called a *shading model* or just *shading*. The process of creating an entire image is called *rendering*.

One of the earliest illumination models from 1971 uses three different components: ambient light, diffuse reflections, and specular reflections. Ambient light is a general light that doesn't have a direction. This sort of light makes it possible for us to see objects that don't have light directed at them. Diffuse reflections occur because light strikes an object directly. These reflections occur in every direction and are based on the angle between the light direction and the surface normal ( $u$  in Figure 14.4). The closer the light direction and the surface normal, the larger the diffuse reflection contribution will be. Specular highlights are the bright spots that appear on objects because of the mirror reflection direction. The specular reflection is based on the angle between the reflection direction and the viewer direction ( $a$  in Figure 14.4). The closer they are, the larger the specular reflection contribution will be. An object's appearance is determined by adding the ambient light, diffuse reflection, and specular reflection together. Although it was developed a long time ago, this illumination model is still commonly used in today's graphics software.

This illumination model does have a notable problem: It makes everything look like it is made of plastic. For this reason, adjustments have to be made to the results it produces to handle metal objects and objects with textures. The illumination model also cannot handle transparent objects or objects with mirror-like surfaces.

A second shading method is called *ray tracing*. In this method, a point in space is identified where the viewer is located. Then the location of the screen (where the image is to be drawn) is determined. Now a line can be drawn from the viewer location through each pixel location of the image. That line or ray is followed into the scene. If it doesn't hit any of the objects, that pixel is colored to match the background color. If it does hit an object, the illumination calculation is performed for that point and the result becomes the pixel color. If the object that is hit is reflective, like a mirror, the direction the ray reflects off the object is calculated and this new direction is followed to determine the pixel color. If the object that is hit is transparent, the direction the ray refracts into the object is calculated and this new direction is followed. Highly complex objects could be both reflective and transparent, so both of these calculations might be done and their results combined. Because the rays are followed as they bounce around a scene, ray tracing can handle both transparent and reflective objects.

You may have noticed that sometimes the color of your shirt reflects onto your face or arms. This phenomenon is called *color bleeding*. Another example occurs when someone wearing a bright red shirt stands near a white wall. The wall near the person can look pink because light reflects off the red shirt before striking the wall. None of the shading methods discussed so far can simulate this type of light interaction, but a technique called *radiosity* can handle color bleeding. In radiosity, light is treated as energy. Complex calculations look at how much energy is transferred from every object to every other object in a scene. Because the amount of energy received by a large object such as a wall will be different for different parts of the wall, large objects are subdivided into much smaller pieces before the energy interaction is calculated.

The amount of energy transferred between two patches in the scene depends on how far apart the two patches are and in which direction the patches are pointing. The farther apart two patches are, the less energy they will transfer. The closer the patches are to facing each other, the more energy they will transfer. This process is further complicated by the fact that Patch A can transfer energy to Patch B and, conversely, Patch B can transfer energy to Patch A. Additionally, the amount of energy Patch A has available to transfer to Patch B depends in part on how much energy Patch A gets from Patch B. Likewise, the amount of energy Patch B transfers to Patch A depends on the amount of energy Patch A transfers to it.

Radiosity is highly complex not only because of all of the potential combinations of energy transfer, but also because a scene can have more than 100,000 patches for which this energy transfer must be determined.

## Modeling Complex Objects

Earlier we said that the shapes of simple objects could be modeled with simple mathematical objects and curved surfaces. Many objects in our world are much more complex in terms of their shapes and the ways that they interact with light. This is one area where graphics researchers are working to produce realistic simulations of natural phenomena that can be rendered in a reasonable amount of time. This section looks at some of these issues in a general way.

Natural landscapes provide a mixture of graphics challenges: realistic-looking terrain, reasonable-looking streams, and natural-looking plants. **FIGURE 14.5** shows a natural-looking computer-generated landscape. Terrain can be modeled with fractal or erosion models. One *fractal model* uses a technique called *midpoint subdivision*. With this technique, you





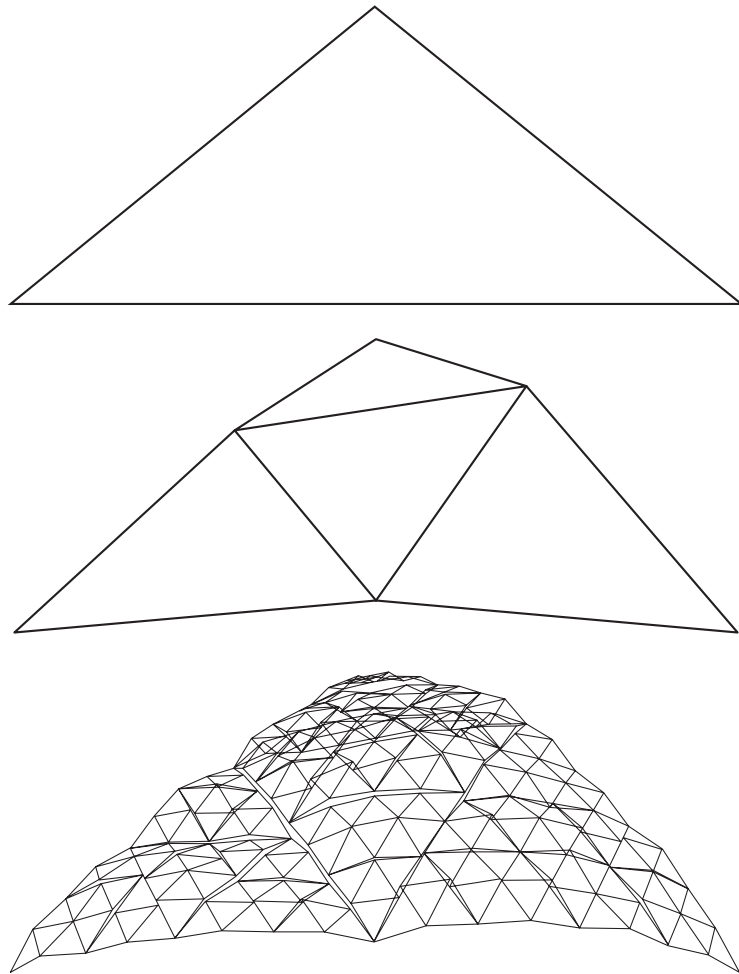
**FIGURE 14.5** A natural computer-generated landscape

Reproduced from Oliver Deussen, et. al., "Realistic Modeling and Rendering of Plant Ecosystems." SIGGRAPH (1998): 275-286. © 1998 AMC, Inc. Reprinted by permission. [<http://doi.acm.org/10.1145/280814.280898>]

begin with a triangular patch. Each side of the triangle is subdivided at the midpoint, and extra edges are added between these points to give 4 triangular patches. The process is repeated again for each of the 4 patches, which produces 16 triangular patches. This result isn't all that interesting by itself. However, if each of the midpoints is randomly moved up or down when subdivided, it generates an irregular terrain shape (FIGURE 14.6). *Erosion models* can be used to place streams and form the terrain around them. In an erosion model, the starting or ending point of the stream is chosen and then the stream is randomly moved through the terrain. The stream location sets the terrain height at those locations, and the areas around the stream can then be raised to irregular levels.

Plant growth has been modeled through both grammar and probabilistic methods. In grammar-based tree models, rules much like those in English grammar specify how components of a plant change. For example, one rule might specify that a bud becomes a flower, while another rule specifies that a bud becomes a branch section with a new bud at its end. Different sets of rules will create different types of plants. Making choices among one set of rules will produce different examples of one plant type. Plant growth can be specified with as few as five to ten rules, depending on the complexity of the plant. In probabilistic models, actual plants are studied to see how

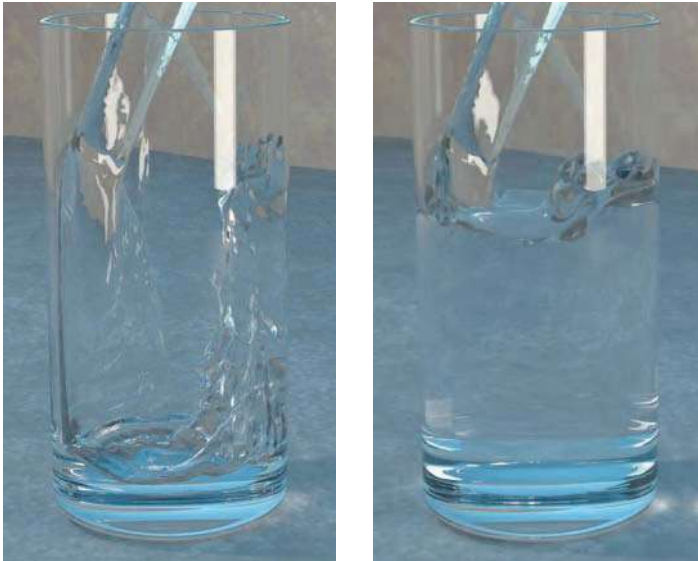




**FIGURE 14.6** Midpoint sub division for creating fractal terrains

they grow. The probabilities of events—for example, that a bud on a plant will stay dormant, become a flower and die, become a new branch or set of branches, or just die—are measured. The lengths of branches and their relative positioning are also measured. The computer then uses all of these probabilities to generate plant shapes for rendering.

Liquids, clouds, smoke, and fire pose special challenges for graphics applications. Scientific researchers have developed equations that approximate the behavior of liquids, gases, and fire. Graphics researchers have, in turn, used these equations to create images of those phenomena. When modeling liquids and gases for computer graphics, the space the liquid or gas will occupy is subdivided into cubic cells. Data on atmospheric



**FIGURE 14.7** Water pouring into a glass

Reproduced from Douglas Enright, et. al., "Animation and Rendering of complex Water Surfaces." SIGGRAPH 21 (2002): 275-286. © 2002 AMC, Inc. Reprinted by permission. [<http://doi.acm.org/10.1145/566654.566645>]

pressure, density, gravity, and external forces are used with these equations to determine how the material moves between cells. **FIGURE 14.7** shows an example of water produced by this method. A cell-based model of clouds looks at the humidity and the presence of clouds in the current and adjacent cells to determine whether a cloud should appear in the current cell. Random numbers are also used to influence cloud formation and movement. These techniques can produce realistic clouds, as seen in **FIGURE 14.8**.



**FIGURE 14.8** Cellular automata-based clouds

Reproduced from Yoshinori Dobashi, et. al., "A Simple, Efficient Method for Realistic Animation of Clouds." SIGGRAPH (2000): 19-28. © 2000 AMC, Inc. Reprinted by permission. [<http://doi.acm.org/10.1145/344779.344795>]



**FIGURE 14.9** A campfire

Reproduced Duc Quang Nguye, et. al., "Physically Based Modeling and Animation of Fire." SIGGRAPH (2002): 721-728. © 2002 AMC, Inc. Reprinted by permission. [<http://doi.acm.org/10.1145/566570.566643>]



**FIGURE 14.10** Blowing smoke

Reproduced Ronald Fedkiw, et. al., "Visual Simulation of Smoke." SIGGRAPH (2001): 15-22. © 2001 AMC, Inc. Reprinted by permission. [<http://doi.acm.org/10.1145/383259.383260>]

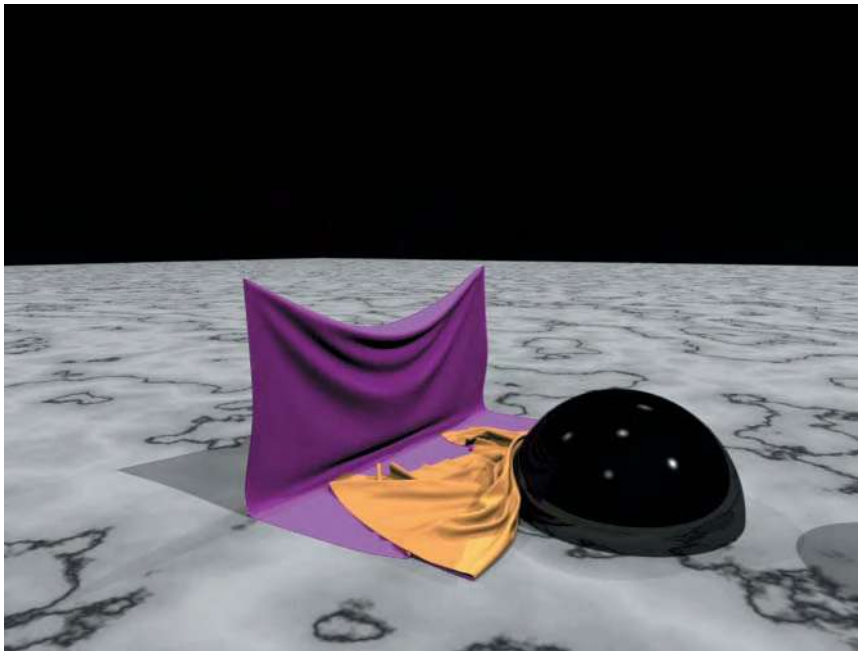
Because smoke and fire are the results of the combustion of a material, heat contributes to the turbulence of the flame and smoke. Equations are also used to model the velocity of fire and smoke particles for the production of images such as those shown in **FIGURES 14.9** and **14.10**.

Cloth comes in two main types—woven and knit. Woven cloth has two sets of threads that are perpendicular. When cloth is woven, some of the vertical threads are up and some are down when a horizontal thread is passed between them. The set of threads that are up and down are changed before the next horizontal thread is added. The colors of the threads and the identities of which are up and down combine to create a pattern in the resulting fabric. Woven cloth can stretch, but only a little, depending on the threads and weaving pattern used. In contrast, knit cloth is created with one long thread or yarn that is interlocked using a series of

loops. A pattern is created in knit cloth by the way that the yarn twists and turns within the loops. Knit cloth is very stretchy and easily deforms around objects.

Cloth that is laying flat isn't very interesting, but the way that cloth moves and drapes is interesting from a graphics standpoint. Modeling the drape of woven cloth can be done simply by looking at the shapes of the threads that make up the cloth. Because of gravity, a rope hanging between two posts takes on a shape known as a *catenary curve*. Modeling a cloth lying over two posts can be done by having the underlying threads form a catenary curve. The challenge is to make sure the cloth doesn't intersect with itself or with other objects—a challenge handled by using constraint techniques to make sure that in the calculations the cloth doesn't intersect something. Other techniques are used to untangle the cloth in situations where the first set of calculations can't prevent the intersection. **FIGURE 14.11** shows an example of cloth that is draping and folded.

Knit cloth poses an entirely different set of problems because as it drapes, the cloth will stretch. This stretch deforms the loops that form the cloth. Furthermore, because knit cloth uses larger yarns, shadows will form in the fabric as the yarn blocks light from another part of the cloth.



**FIGURE 14.11** A simulation of cloth showing bending and draping

Courtesy of Robert Bridson. © 2004 Robert Bridson

The thickness and fuzziness of the yarn also influence the cloth's appearance. One graphics technique for depicting knit cloth treats the path of the yarn in the cloth as a long curve. Points on the curve are associated with points on a plane to model the knit fabric at rest. To place the fabric on an object, the plane is deformed to the shape of the object. The deformation of the plane changes the locations of the points on the curve. The new locations of these points reflect where the knit fabric stretches and bends. Rendering the fabric then becomes a matter of rendering the yarn as it travels along the now deformed curve.

Skin requires special graphics techniques to handle both its shape and its appearance. Skin is soft and has a shape that depends on the underlying muscles and bone. As muscles contract and relax, our body shape changes and thus our skin will deform. Skin also stretches, wrinkles, and creases as our joints move. In graphics, an advanced technique called *implicit surfaces* can be used to model the shape of skin. For example, the equation for a sphere ( $x^2 + y^2 + z^2 = r^2$ ) does not explicitly give the  $x$ ,  $y$ , and  $z$  values that are on the surface of the sphere. Rather, we can try different values for  $x$ ,  $y$ , and  $z$  until we find the ones that satisfy this equation for a given radius. Thus we implicitly find the points on the surface of the sphere. For skin, an even more complex set of equations is used to specify the implicit surface.

Once the shape of the skin is determined, skin must be rendered differently than most other objects. When light strikes the skin, some of the light reflects off the oils on the skin and the rest of the light actually penetrates the top layers of skin. The light that penetrates the skin will reflect off lower layers, pigment particles, and blood before emerging from the skin. If you look at your hand, you will probably notice that you clearly see the outer surface but that you also see underlying blood vessels and maybe even freckles. To accurately render skin, the graphics application must account for this subsurface scattering of light. Subsurface scattering must also be handled to accurately render marble and food products such as milk.

## Getting Things to Move

So far, we have been talking about graphics from the perspective of a single image, but games and animated films require many images. A film uses 24 images per second and video uses 30 images per second. These images are shown rapidly, so that we perceive the changes between images as continuous motion. A 60-minute animated film requires 86,400 images and a 60-minute video requires 108,000 images. The work done for each

individual image is the same even though that image is now part of a sequence of images.

Animation does pose a new challenge, however, if we want to create believable movement of objects. Deciding how to change the positions of objects between the images must be done carefully if the movement is to look realistic. In some cases, realistic movement can be generated based on physical properties. For example, if a ball is thrown into the air, we can predict how it will slow down and stop before falling to the ground based on the laws of gravity.

Having an object move from point A to point B in 10 seconds is not as simple as dividing the distance into 299 equal changes for the 300 images needed for the 10-second video. That result will not look realistic because when objects move there is a period during which their speed is increasing, called the *ease-in* in animation. During the *ease-in*, the object will move in smaller but increasing amounts between each frame. Also, the object will not come to a sudden stop, but rather will slow down until stopped, which is called the *ease-out* in animation. As a consequence, the change in distance for the ending images will get smaller with each additional image.

Animating figures is even more complex. We are very familiar with the movements of humans and animals, so even small problems in motion will obviously look unnatural. We are so good at recognizing motion of figures that we can recognize that someone in the distance is a friend by the way the person walks, even if he or she is not close enough for us to recognize the face. We can also sometimes identify someone approaching us, even if we merely hear the sounds of their footsteps.

Consider the process of having a character reach for an object. When we reach for something, the entire arm moves. If the object is just out of reach, the shoulder will move and the upper body will either bend at the waist or twist around the waist. To do this, the positioning of all of the arm segments and joints changes. Animating a character to reach could be done by determining where the hand needs to be and then determining what angles the joints should be for the hand to get to its destination. Over the length of the animation, we can change the joint angles from their starting values to the final values. Although this approach would deliver the motion needed, the result might not look realistic. This process becomes even more complex if we have to calculate a path of motion to avoid other objects in the scene.

Graphics researchers are using information gleaned through the study of human and animal motion to develop systems that can automatically generate more natural motion. There is, however, a way to

cheat—motion capture. In motion capture, sensors are placed at significant locations on a person's body. The human then moves the way that the character is supposed to move. The location of the sensors is tracked during the entire motion. The sensor locations indicate where the equivalent part of the character should be during the movement. In this way, the sensor locations tell the graphics application where the character should be positioned for each of the images of the animation. This technique works well for film animation because the character movement is known. It doesn't work for computer games, where the movement of the character depends on what is occurring in the game.

In our day-to-day lives, we do many things without thinking about them. We see objects without thinking about the way they are illuminated by light. We move ourselves and objects without thinking about the locations of our joints or how to avoid hitting other objects. But when it comes to computer graphics, we have to think about all of these concerns because we have to write computer programs to create images showing just these sorts of things.

## 14.4 Gaming

**Computer gaming** A computer simulation of a virtual world

**Computer gaming** is a computer simulation of a virtual world that draws players into the world as participants. Although computer games can be used as teaching tools, their primary function is to entertain.

A virtual world, which is also known as a *digital* or *simulated* world, is an interactive, computer-generated environment. Such worlds are often designed to resemble reality, where real-world rules and laws would still be applicable (to the character you are playing, of course), but they can also be built as deep fantasy worlds where such rules do not apply. Although there are many different types of virtual worlds, persistent online virtual worlds all tend to share the same basic features. They are usually active all day, every day, barring any downtime for maintenance; the game continues to be played, whether individual players are logged in or not. Multiple players can participate in the games at the same time, with the entire interaction taking place in real time.

Virtual worlds are highly social places, encouraging players to form teams, guilds, neighborhoods, and clubs within the game. Unlike flat, one-dimensional games such as Solitaire, many of today's virtual worlds encompass 3D environments that are designed to immerse the player in the world in which he or she is playing.

Creativity and technological savvy are both required to create the virtual world of a computer game. Designers must be cognizant of aspects



of computer science such as computer graphics, artificial intelligence, human–computer interaction, simulation, software engineering, and computer security, in addition to the fundamentals of mathematics. To make people, objects, and environments behave realistically in a virtual environment, programmers and designers also need to be aware of the laws of physics relating to gravity, elasticity, light, and sound. Games may use fake physics, but the rules of the fake physics must be consistent and believable within the context of the game.

## History of Gaming

The general meaning of *gaming* has evolved over the past few decades. The first electronic games were developed in the 1940s, using a device that allowed a user to control a vector-drawn dot on the screen to simulate a missile being fired at targets. In 1971, the first coin-operated video game was sold on the commercial market. Gaming didn't really start to take off until the invention of the Atari 2600 and *Pong*, its wildly popular game, in 1977. The success of Atari's game console opened the doors for companies such as Nintendo and Sony, which have since released many popular game consoles, such as Nintendo 64, Nintendo Wii, and Sony Playstation.

One way of classifying games is by the type of platform they use: handheld games such as Nintendo's Game Boy, consoles such as Nintendo 64 and Microsoft's Xbox that plug into a television, or computer games that are either self-contained or offered over the Internet. Regardless of the platform, there is always a computer in the background running the simulation.

Another way of classifying games is by genres, based on the **gameplay**. Gameplay is the type of interactions and experiences a player has during the interaction within the game. *Action* games require a player to use quick reflexes and timing to overcome obstacles. There are many sub-genres of action games, such as *beat 'em up* and *hack-and-slash* games, which include one-on-many close combat situations. In contrast, *fighting* games emphasize one-on-one combat. Another subgenre of action games places the virtual world entirely within a maze.

*Shooter* games focus on using projectile weapons in combat. *Action-adventure* games present both short-term and long-term obstacles that must be overcome to succeed. *Life-simulation* games allow the player to control one or more artificial lives. *Role-playing* games allow the player to become a character in the story line of the game. *Strategy* games require careful problem solving and planning to achieve victory within the confines of the game.

**Gameplay** The type of interactions and experiences a player has during the game



## Creating the Virtual World

**Game engine** A software system within which computer games are created

A **game engine** is a software system within which games can be created. A game engine provides tools with the following functionality:

- A rendering engine for graphics
- A physics engine to provide a collision detection system and dynamics simulation to solve the problems related to forces affecting the simulated objects
- A sound-generating component
- A scripting language apart from the code driving the game
- Animation
- Artificial intelligence algorithms (e.g., path-finding algorithms)
- A scene graph, which is a general data structure to hold the spatial representation in a graphical scene

Collectively, these tools enable the game developer to create the virtual world of a game. All game engines need to include a renderer, which uses a large chunk of the CPU's processing. The renderer actually visualizes the scene, putting the environment up on the screen for the user to view. In addition, 3D objects are kept as vertices in a 3D world, showing the computer where to fill in images on the screen. This is all part of the renderer's functions.

A physics engine simulates models based on Newtonian physics, using mass, velocity, friction, and wind resistance calculations to determine which effects would occur in the real world, so that those effects can then be duplicated in the game engine. The accuracy of the simulation depends on the processing power of the system being used to create the content. High-precision physics engines use more processing power to determine exact calculations, so they are usually applied to animated movies. The physics engine used for computer gaming simplifies the calculations in the game to make sure that a real-time response to an action is achieved.

Collision detection algorithms check the accuracy of collision points or the intersection of two solids. For example, in a game of bowling, a collision detection algorithm would be used to determine the accuracy of the collision that occurs when the bowling ball intersects with the pins. These calculations can apply to solid objects, liquids, and even "human" characters. *Rag-doll physics* is a type of simulation used to accurately animate a "dying" character's movements or the movements of characters who are fighting. Rather than having characters drop limply to the ground, rag-doll physics essentially connects a character's "bones" through a series of joints (just as an actual human has) to simulate realistic movement.

Artificial intelligence provides the illusion of intelligence in the behavior and actions of nonplayer characters. Essentially, it gives nonhuman entities algorithmic and mathematical solutions for problem solving, simulation of human thought, and decision making. While that might not sound terribly complicated, each idea must be expressed through mathematical expression or a script that calculates the odds and anticipates possible actions of the other human players. These nonplayer characters also need to have “knowledge” of language, planning, recognition, and the ability to learn from the actions of those human players around them.

## Game Design and Development

The game design process begins with a concept, preferably one that nobody has seen before. After much brainstorming, the designer completes a game design document, outlining the many different aspects of the game, including its story line, art, characters, and environment. After the initial team is assigned to the project, the technical ideas for the game really start to flow, as designers, programmers, and artists seek to ensure that the most cutting-edge technology that they have at their fingertips is included in the game.

Once the game technology is at the point where actual gameplay can be developed, the game design is often broken down into fundamental tasks, such as construction of a small game segment, with subsequently developed segments then building on that part. For example, when working on character movement, designers would first develop each movement individually. They might start by making the characters move backward and forward and turn in multiple directions, thereby ensuring that basic navigation through the game is functioning. They would then build on that movement by adding options such as running, jumping, or crouching. After each new section of the game is introduced, the team must verify that the parts of the game developed previously still function with the new aspects of the game.

The development of a new virtual environment requires decisions about how advanced the graphics and simulations in the game should be. Developers may need to decide between a 2D and a 3D game, or even whether artificial intelligence technology will be included in the game. 3D images are created through the process of rendering—that is, using computer programs to generate an image from a model. Much like an artist’s rendering of a scene, the computer model would contain geometry, viewpoint, texture, lighting, and shading information, all of which would allow the 3D image to be created with as much detail as possible.

### Siri helps autistic child

Siri, Apple’s iPhone assistant, became the best friend of an autistic 13-year-old boy. She answered insistent and repetitive questions patiently, never getting irritated. She even chided him when he uttered expletives.<sup>9</sup>

Designers need to develop their ideas beyond the storyline, character descriptions, and environmental specifications. Put simply, they have to think about *how* the characters and the environment will interact. These very visual aspects of the game may need a great deal of fine-tuning before designers, programmers, and artists are satisfied with the results. Inevitably, some elements will be missing from the design and will need to be added in later. For example, do the characters walk or stroll when they move? Does the clothing move with the characters' movements? If the game is set outside, are all the true elements of nature included? Does the wind blow? Are there birds and clouds in the sky? Do players design their characters' history themselves, or is that information written into the script? If the game is a fantasy, which powers will the characters have? The list of elements that designers need to think about is endless.

Although the first level of development sets the basic parameters for the design of the game, the design constantly evolves and changes throughout the development and production process. It is nearly impossible to stick to the original design, as the development of a game involves too many different aspects, such as mechanics, art, programming, audio, video, and scripting. All of these aspects depend on one another, and all of them need to remain flexible as other features of the game advance. A big part of the game design process is being willing to abandon much of the work that has been completed when it becomes evident that the game needs to go in a new direction. The game's content may need to change as the game evolves, features and levels may be removed or added, art may advance, and the entire backstory of the game may change.

## Game Programming

When all the design decisions have been made, programmers produce the code to create the virtual world of the game. The coding process is the single biggest endeavor in game production, as it essentially runs all aspects of the game. Java is typically used for Android games. Apple developers often use Objective C for mobile game development. C# is also popular for game development, along with JavaScript and Lua. Some prominent engine developers have created custom languages for games based on their engines, such as Epic Game's UnrealScript for the Unreal engine and Unity 3D.

A variety of application programming interfaces (APIs) and libraries are available to assist developers with key programming tasks in the game. The choice of API determines which vocabulary and calling conventions the programmer should employ to use the services. The target

game platform determines which service the programmer will use. Some libraries allow for cross-platform development, which streamlines the development pipeline and allows the programmer to program a game in a single language that will run on several platforms (such as Microsoft Windows [for PCs], Nintendo Wii, and Playstation). Also, because graphics are such an important feature in today's gaming industry, graphic APIs (such as Direct3D) are available to render 3D graphics in advanced applications.

The coding begins with creation of the *game loop*. The game loop is responsible for managing the game world, regardless of whether the user has provided any input. For example, the game loop might update the enemy movement in the game, check for victory/loss conditions, update the game elements throughout the game world, and process input if provided. In short, the game loop manages the simulation.

Often, large design teams will have different programmers who focus on different aspects of the game. For example, the senior engine programmer may write and maintain the code for the game loop, design in-game engine editors, and make sure that the file formats are acceptable for importing and exporting 2D and 3D art packages and audio/video files. The 3D software programmer may design and implement the 3D graphics component, while the user interface programmer works on the APIs in the game engine. The programmers work together to create a streamlined, working game.

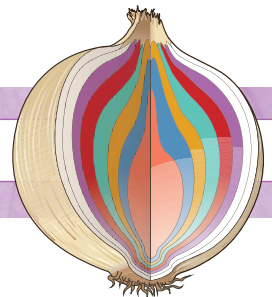
Despite beta testing and demoing, new computer games often have bugs. The beauty of online games is that any "fixes," maintenance, or addition of new features and upgrades can be performed without interrupting the ongoing action.

© Artur Debat/Getty Images, © Alan Dyer/Stocktrek Images/Getty Images

## SUMMARY

Simulation is a major area of computing that involves building computer models of complex systems and experimenting with those models to observe their results. A model is an abstraction of the real system in which the system is represented by a set of objects or characteristics and the rules that govern their behavior.

There are two major types of simulation: continuous and discrete event. In continuous simulation, changes are expressed in terms of partial differential equations that reflect the relationships among the set of objects or characteristics. In discrete-event simulation, behavior is expressed in



terms of entities, attributes, and events, where entities are objects, attributes are characteristics of an entity, and events are interactions among the entities.

Queuing systems are discrete-event simulations in which waiting time is the factor being examined. Random numbers are used to simulate the arrival and duration of events, such as cars at a drive-through bank or customers in a supermarket. Meteorological and seismic models are examples of continuous simulation.

Computer graphics is a fascinating area that combines computers, science, and art. Much of graphics depends on mathematical equations that simulate the natural phenomena presented in the image. Computer graphics combines light interactions, object properties such as transparency and surface texture, object shape, and physical properties to produce images that approach the realism of an actual photograph.

Computer gaming is the simulation of a virtual world within which the players can interact with the system and with each other. A game engine is a software system within which game developers, designers, and programmers create a game's virtual world.



## ETHICAL ISSUES

### Gaming as an Addiction

The term *addiction* refers to an obsession, compulsion, or excessive psychological dependence on things such as drugs, alcohol, pornography, gambling, and food. Experts have been exploring a new addiction: video gaming. Gaming addiction exhibits similar symptoms as other impulse-control disorders. These symptoms include problems at work or school, lying to family and friends, decreased attention to personal health, carpal tunnel syndrome, dry eyes, failure to stop playing games, and sleep disturbances.

Studies conducted at the Stanford University School of Medicine have found evidence that video gaming does, indeed, have addictive characteristics. Dr. Maressa Hecht Orzack, a clinical psychologist at McLean Hospital in Massachusetts and founder of Computer Addiction Service, claims that as many as 40% of World of Warcraft (a wildly popular MMORPG—massively multiplayer online role-playing game) players are addicted, and states that these games should come with warning labels, much like cigarette packages do. Experts believe that these addictions are caused by individuals' needs to form human connections, which they may be unable to achieve in the real world but can easily achieve in a virtual fantasy world.

A 2007 Harris Interactive poll of 8- to 18-year-olds in the United States showed that the average time spent playing video games varies by age and gender, with teenage males averaging about five hours more per week than females. The Harris poll claimed that 8.5% of the teens surveyed could be "classified as pathological or clinically 'addicted' to playing video games." An MRI study conducted as part of the research at Stanford University showed that the region of the brain that produces satisfying feelings is more active in males than females during video game play.

Some countries have issued restrictions on the length of time that users can play online games. China, for example, issued a rule in 2005 that limited online game play to three hours per day. However, in 2007 the rule was changed, allowing players younger than age 18 to play for an unlimited length of time but cutting off any experience their characters might gain after five hours of play.

Many countries, including China, the Netherlands, the United States, and Canada, have opened treatment centers, allowing people who are addicted to video games to go through a form of detoxification (detox). However, treatment for video game users is



## ETHICAL ISSUES

### Gaming as an Addiction (CONTINUED)

quite different from detoxing from an alcohol or drug addiction. Because computers are such an important part of a person's everyday routine at school or work, video game addicts must learn to use computers responsibly rather than avoiding them altogether.

In May 2013, video game addiction was added to the American Psychiatric Associ-

ation's *Diagnostic and Statistical Manual of Mental Disorders* (DSM) in the "Conditions for Further Study" section as *Internet gaming disorder*. In January 2014, Internet gaming disorder was included in the DSM as a formal diagnosis.

© Artur Debat/Getty Images; © Alan Dyer/Stocktrek Images/Getty Images

## KEY TERMS

Computational biology  
Computer gaming  
Game engine

Game play  
Model  
Simulation

© Artur Debat/Getty Images; © Alan Dyer/Stocktrek Images/Getty Images

## EXERCISES

For Exercises 1–8, match the kind of simulation with the example.

- A. Continuous simulation
  - B. Discrete-event simulation
1. Weather forecasting
  2. Stock portfolio modeling
  3. Seismic exploration
  4. Hurricane tracking
  5. Predicting the number of tellers a new bank needs

6. Determining the number of waiting rooms necessary for a doctor's office
7. Gas exploration
8. Air pollution movement

For Exercises 9–24, mark the answers true or false as follows:

- A. True
  - B. False
9. Simple systems are best suited to being simulated.

**EXERCISES (CONTINUED)**

10. Complex systems are dynamic, interactive, and complicated.
  11. A model is an abstraction of a real system.
  12. The representation of a model may be concrete or abstract.
  13. In computer simulations, the models are concrete.
  14. The more characteristics or features represented in a model, the better.
  15. Continuous simulations are represented by entities, attributes, and events.
  16. Discrete-event simulations are represented by partial differential equations.
  17. CAD stands for *computer-aided drafting*.
  18. A time-driven simulation can be thought of as a big loop that executes a set of rules for each value of the clock.
  19. A model whose realization is within a computer program is an abstract model.
  20. A concrete model can be realized within a computer program.
  21. Red is the specular highlight on a green plastic ball if the light source is red.
  22. A commonly used illumination model in computer graphics was developed in the 1970s.
  23. Ambient light, diffuse reflection, and specular reflection are three components of a common shading model for computer graphics.
  24. Computer graphics relies on research from other scientific fields for equations used in image creation.
- Exercises 25–52 are problems or short-answer questions.
25. Define *simulation* and give five examples from everyday life.
  26. What is the essence of constructing a model?
  27. Name two types of simulations and distinguish between them.
  28. What are the keys to constructing a good model?
  29. What defines the interactions among entities in a discrete-event simulation?
  30. What is the relationship between object-oriented design and model building?
  31. Define the goal of a queuing system.
  32. What are the four pieces of information needed to build a queuing system?
  33. What part does a random number generator play in queuing simulations?
  34. Write the rules for a queuing simulation of a one-pump gas station, where a car arrives every three minutes and the service time is four minutes.
  35. Do you think the gas station in Exercise 34 will be in business very long? Explain.
  36. Rewrite the simulation in Exercise 34 such that a car arrives every two minutes and the service time is two minutes.



**EXERCISES (CONTINUED)**

37. Write the rules for a queuing system for an airline reservation counter. There are one queue and two reservation clerks. People arrive every three minutes and take three minutes to be processed.
38. Distinguish between a FIFO queue and a priority queue.
39. What did SIMULA contribute to object-oriented programming methodology?
40. In general, meteorological models are based on the time-dependent equations of what fields?
41. How much study of mathematics is necessary to be a meteorologist?
42. Why is there more than one weather prediction model?
43. Why do different meteorologists give different forecasts if they are using the same models?
44. What are specialized meteorological models, and how are they used?
45. What are seismic models used for?
46. A random-number generator can be used to vary service times as well as determine arrivals. For example, assume that 20% of customers take eight minutes and 80% of customers take three minutes. How might you use a random-number generator to reflect this distribution?
47. Why do we say that simulation doesn't give an answer?
48. What do simulations and spreadsheet programs have in common?
49. Explain why shadows are important in graphics applications.
50. What type of mathematical objects would you need to use to create a model of a table?
51. Explain why it is so difficult to get objects to move in computer animation.
52. Name five areas encompassed by computational biology.

## THOUGHT QUESTIONS

1. Priority queues (PQs) are very interesting structures. They can be used to simulate a stack. How might you use a PQ as a stack?
2. Priority queues can also be used to simulate a FIFO queue. How might you use a PQ as a FIFO queue?
3. In Chapter 8, we described the graph data structure. A depth-first traversal of a graph uses a stack, and a breadth-first traversal of a graph uses a FIFO queue. Can you explain why?
4. In this chapter we described queuing systems where there is a queue for each server. Other types of queuing systems exist as well. For example, in the airport there is usually one queue for many servers. When a server is free, the person at the front of the queue goes to that server. Could you represent this type of system in a simulation?
5. What other real-life situations can be modeled using a priority queue?
6. CAD systems are now available for everyday use. Go to your local computer store and see how many programs are available to help you design anything from a kitchen to a guitar.
7. Do you see video gaming as a problem for you or your friends? Has it affected your own or a friend's schoolwork?
8. Do you know anyone whom you might consider to be addicted to video gaming?

## Laying the Groundwork

- 1 The Big Picture

## The Information Layer

- 2 Binary Values and Number Systems
- 3 Data Representation

## The Hardware Layer

- 4 Gates and Circuits
- 5 Computing Components

## The Programming Layer

- 6 Low-Level Programming Languages and Pseudocode
- 7 Problem Solving and Algorithms
- 8 Abstract Data Types and Subprograms
- 9 Object-Oriented Design and High-Level Programming Languages

## The Operating Systems Layer

- 10 Operating Systems
- 11 File Systems and Directories

## The Applications Layer

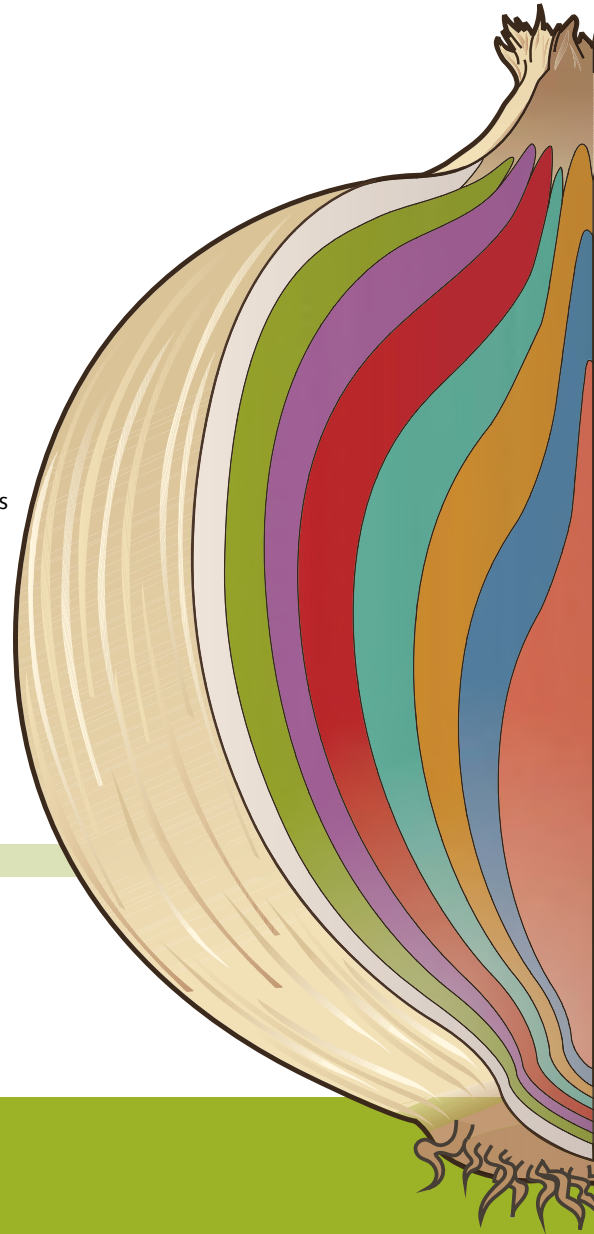
- 12 Information Systems
- 13 Artificial Intelligence
- 14 Simulation, Graphics, Gaming, and Other Applications

## The Communications Layer

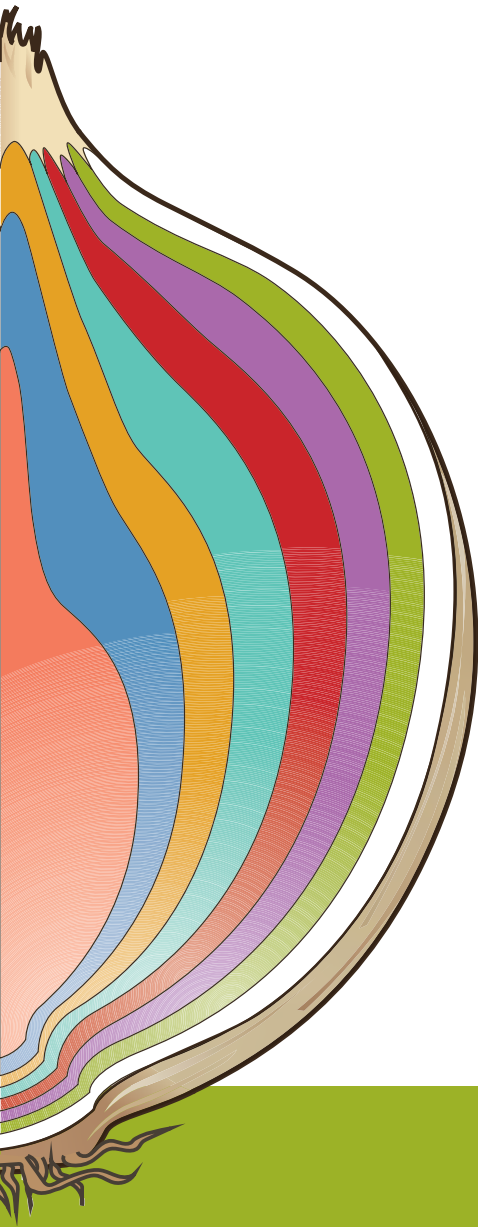
- 15 Networks
- 16 The World Wide Web
- 17 Computer Security

## In Conclusion

- 18 Limitations of Computing



# THE COMMUNICATIONS LAYER



## 15

# NETWORKS

For many years, computers have played as important a role in communication as they do in computation. This communication is accomplished using computer networks. Like complex highway systems that connect roads in various ways to allow cars to travel from their origin to their destination, computer networks form an infrastructure that allows data to travel from some source computer to a destination. The computer receiving the data may be around the corner or around the world. This chapter explores some of the details of computer networks.

## GOALS

After studying this chapter, you should be able to:

- describe the core issues related to computer networks.
- list various types of networks and their characteristics.
- explain various topologies of local-area networks.
- explain why network technologies are best implemented as open systems.
- compare and contrast various technologies for home Internet connections.
- explain packet switching.
- describe the basic roles of network protocols.
- explain the role of a firewall.
- compare and contrast network hostnames and IP addresses.
- explain the domain name system.
- describe cloud computing and its benefits.

**Computer network**

A collection of computing devices connected so that they can communicate and share resources

**Wireless**

A network connection made without physical wires

**Node (host)** Any addressable device attached to a network

**Data transfer rate (bandwidth)**

The speed with which data is moved from one place to another on a network

**Protocol** A set of rules that defines how data is formatted and processed on a network

**Client/server model**

A distributed approach in which a client makes requests of a server and the server responds

## 15.1 Networking

A **computer network** is a collection of computing devices that are connected in various ways to communicate and share resources. Email, instant messaging, and web pages all rely on communication that occurs across an underlying computer network. We use networks to share both intangible resources, such as files, and tangible resources, such as printers.

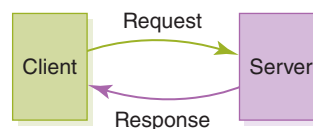
Usually, the connections between computers in a network are made using physical wires or cables. However, some connections are **wireless**, using radio waves or infrared signals to convey data. Networks are not defined only by physical connections; they are defined by the ability to communicate.

Computer networks contain devices other than computers. Printers, for instance, can be connected directly to a network so that anyone on the network can print to them. Networks also contain a variety of devices for handling network traffic. We use the generic terms **node** or **host** to refer to any device on a network.

A key issue related to computer networks is the **data transfer rate**, the speed with which data is moved from one place on a network to another. We are constantly increasing our demand on networks as we rely on them to transfer more data in general, as well as data that is inherently more complex (and therefore larger). Multimedia components such as audio and video are large contributors to this increased traffic. Sometimes the data transfer rate is referred to as the **bandwidth** of a network. (Recall that we discussed bandwidth in Chapter 3 in the discussion of data compression.)

Another key issue in computer networks is the **protocols** they use. As we've mentioned at other points in this book, a protocol is a set of rules describing how two things interact. In networking, we use well-defined protocols to describe how transferred data is formatted and processed.

Computer networks have opened up an entire frontier in the world of computing called the **client/server model**. No longer do you have to think of computers solely in terms of the capabilities of the machine sitting in front of you. Instead, software systems are often distributed across a network, in which a client sends a request to a server for information or action, and the server responds, as shown in [FIGURE 15.1](#).



**FIGURE 15.1** Client/server interaction

For example, a **file server** is a computer that stores and manages files for multiple users on a network. That way every user doesn't need to have his or her own copy of the files. A **web server** is a computer dedicated to responding to requests (from the browser client) for web pages. Client/server relationships have become more complex as we rely heavily on networks in our everyday lives. Therefore, the client/server model has become increasingly important in the world of computing.

The client/server model has also grown beyond the basic request/response approach. Increasingly, it is being used to support parallel processing, in which multiple computers are used to solve a problem by breaking it into pieces, as discussed in Chapter 5. Using networks and the client/server model, parallel processing can be accomplished by the client requesting that multiple machines perform specific, separate parts of the same problem. The client then gathers their responses to form a complete solution to the problem.

Another approach for computer interaction across networks is the **P2P model**, or *peer-to-peer model*. Instead of having a central server from which clients obtain information, a peer-to-peer network is decentralized, with nodes that share both resources and the responsibility for making these resources available to other peers. Depending on the request, a peer may act as a client or a server.

In a P2P network, a request for a file may go to several other peers in the network. If a peer does not have the file, it forwards the request to other peers, and so on, until the file is found. Then (usually) a connection is made directly between the requesting peer and the peer that has the resource to transfer the file.

The P2P model eliminates the need for a single server to hold all resources because it distributes the communication among many computers. However, these advantages also bring drawbacks: A P2P network is more difficult to administer and prone to security problems.

## Types of Networks

Computer networks can be classified in various ways. A **local-area network (LAN)** connects a relatively small number of machines in a relatively close geographical area. LANs are usually confined to a single room or building. They may sometimes span a few close buildings.

Historically, various configurations, called *topologies*, have been used to administer LANs. A **ring topology** connects all nodes in a closed loop on which messages travel in one direction. The nodes of a ring network pass along messages until they reach their destination. A **star topology**

**File server A**  
computer dedicated to storing and managing files for network users

**Web server A**  
computer dedicated to responding to requests for web pages

**P2P model A**  
decentralized approach that shares resources and responsibilities among many "peer" computers

**Local-area network (LAN)** A network connecting a small number of nodes in a close geographic area

**Ring topology A**  
LAN configuration in which all nodes are connected in a closed loop

**Star topology A** LAN configuration in which a central node controls all message traffic

**Bus topology** A LAN configuration in which all nodes share a common line

**Wide-area network (WAN)** A network connecting two or more local-area networks

**Gateway** A node that handles communication between its LAN and other networks

**Internet** A wide-area network that spans the planet

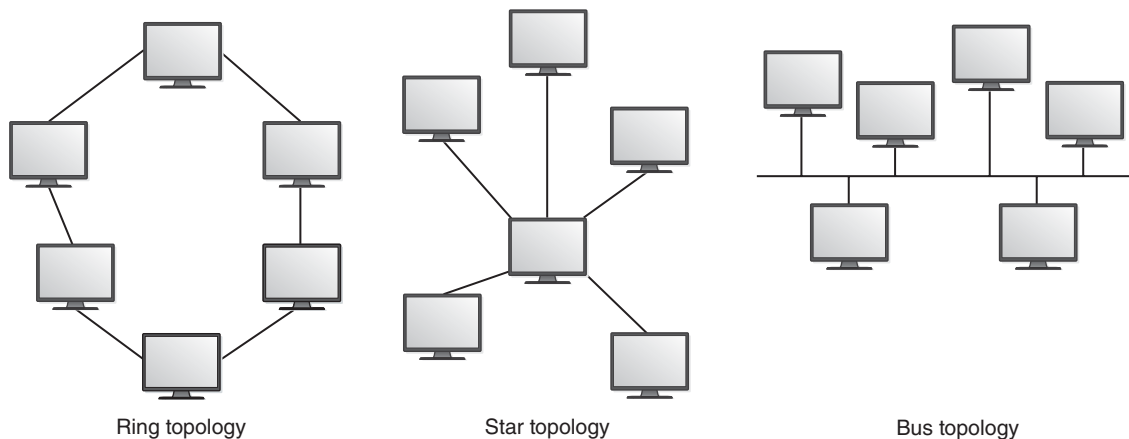
**Metropolitan-area network (MAN)** A network infrastructure developed for a large city

centers on one node to which all others are connected and through which all messages are sent. A star network puts a huge burden on the central node; if it is not working, communication on the network is not possible. In a **bus topology**, all nodes are connected to a single communication line that carries messages in both directions. The nodes on the bus check any message sent on the bus but ignore any that are not addressed to them. These topologies are pictured in [FIGURE 15.2](#).

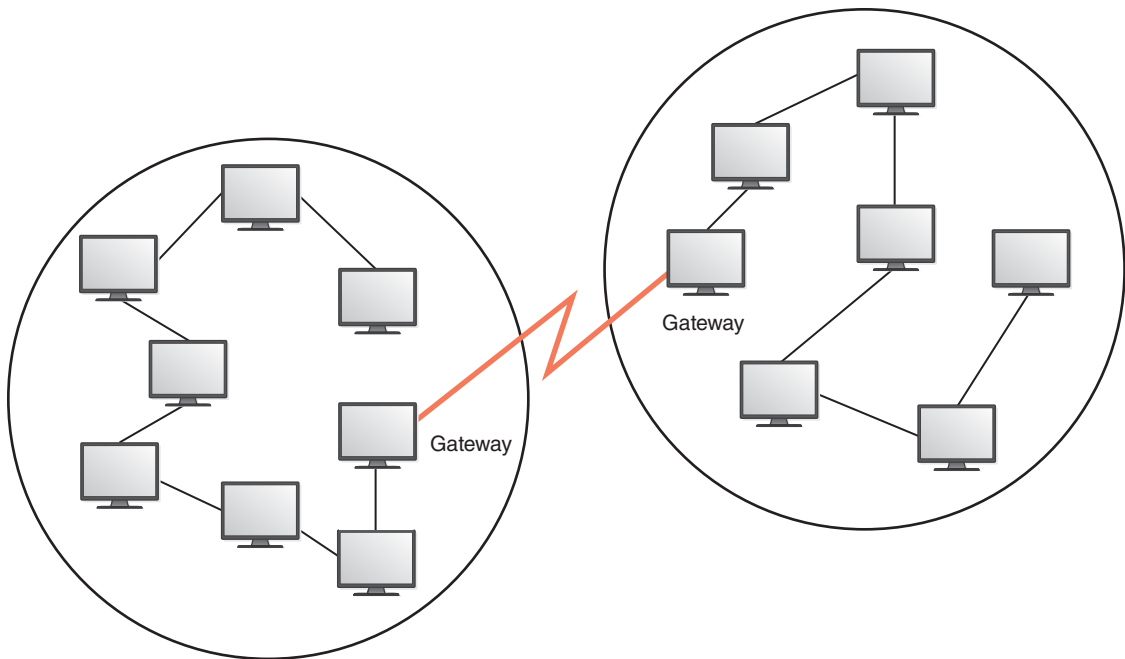
A **wide-area network (WAN)** connects two or more local-area networks over a potentially large geographic distance. A WAN permits communication among smaller networks. Often one particular node on a LAN is set up to serve as a **gateway** to handle all communication going between that LAN and other networks. See [FIGURE 15.3](#).

Communication between networks is called *internetworking*. The **Internet**, as we know it today, is essentially the ultimate wide-area network, spanning the entire globe. The Internet is a vast collection of smaller networks that have all agreed to communicate using the same protocols and to pass along messages so that they can reach their final destination.

The term **metropolitan-area network (MAN)** is sometimes used to refer to a large network that covers a campus or a city. Compared to a general wide-area network, a MAN is more narrowly focused on a particular organization or geographic area. A MAN that services a college or business campus typically interconnects the local-area networks used by various buildings and departments. Some cities have formed a MAN in their geographical area to service the general populace. Metropolitan-area networks are often implemented using wireless or optical fiber connections.



**FIGURE 15.2** Network topologies



**FIGURE 15.3** Local-area networks connected across a distance to create a wide-area network

## Wireless and Mobile Computing

Today we are often computing on the go, using wireless devices such as smartphones, tablets, and laptops. A **wireless network** is one in which at least one node serves as a *wireless access point*, allowing appropriate devices to interact with other network resources without being physically connected. That access point is usually wired to other network nodes in conventional ways.

You may, for instance, have a wireless access point set up in your home or business that allows your tablet to connect to the Internet. Using radio waves, your tablet exchanges information with the wireless access point, which in turn communicates with other network resources, including the node that is connected to the Internet.

Wireless networks give the user tremendous freedom and flexibility. They greatly reduce installation costs by eliminating the need to run wires. However, they are more prone to electromagnetic interference than wired networks, and they must cope with access control challenges that a wired connection does not.

On a smaller scale, **Bluetooth** technology allows wireless communication between devices over a short distance. A Bluetooth device uses radio waves in a particular bandwidth and is significantly limited in range

### Wireless network

A network in which devices communicate with other nodes through a wireless access point

### Bluetooth

A technology used for wireless communication over short distances



**Latency** The time that elapses between the transmission of a request and its receipt

#### Internet backbone

A set of high-speed networks carrying Internet traffic

#### Internet service provider (ISP)

An organization providing access to the Internet

#### Phone modem

A device that converts computer data into an analog audio signal and back again

?

#### SETI at home

SETI@Home (SETI at home) is a distributed computing experiment that uses Internet-connected computers in the search for extraterrestrial intelligence (SETI). It is hosted by the Space Sciences Laboratory at the University of California, Berkeley. SETI@home uses spare computing capacity on users' computers to analyze data collected by the Arecibo radio telescope, which is searching for possible evidence of

compared to other wireless technology. However, it solves many short-range problems, such as communication between your cell phone and a hands-free headset, between your media device and a car stereo system, and between a computer and a wireless keyboard, mouse, or trackpad.

## Internet Connections

Who owns the Internet? Well, no one. No single person or company owns the Internet or even controls it entirely. As a wide-area network, the Internet is made up of many smaller networks. These smaller networks are often owned and managed by a person or organization. The Internet, then, is defined by how connections can be made among these networks.

The speed of these interconnected networks determines how fast you get your results. The **latency** of a network system is the time that elapses between the transmission of a request and its receipt. The general goal, then, is to minimize latency on a network, which ultimately defines its speed.

The **Internet backbone** refers to a set of high-capacity data routes that carry Internet traffic. These routes are provided by various companies such as AT&T, Verizon, and British Telecom, as well as by several government and academic sources. The backbone networks all operate using connections that have high data transfer rates, ranging from 40 gigabits (Gb) per second to more than 100 Gb per second. Newer technologies will likely increase these speeds further in the near future. Keep in mind, though, that Internet routes, including the backbone networks, employ a large amount of redundancy, so there is really no central network.

Organizations that provide companies or individuals with access to the Internet are called **Internet service providers** (ISPs). TV cable and satellite companies often provide ISP services as well, which makes sense given the communication infrastructure they already have in place. An ISP is not always a commercial organization, though—some are set up as community or nonprofit organizations. An ISP connects directly to the Internet backbone or to a larger ISP that has a connection to the backbone.

One of the earliest technologies for connecting a home computer to the Internet was the phone modem. Today, the two most popular techniques are digital subscriber lines and cable modems. Let's examine each in turn.

The telephone system had already connected homes throughout the world long before the desire for Internet connections came along. Therefore, it makes sense that the first technique for home-based network communication was a phone modem. The word *modem* stands for *modulator/demodulator*. A **phone modem** converts computer data into an analog audio signal for transfer over a telephone line, and then a modem

at the destination converts it back into data again. One audio frequency is used to represent binary 0 and another to represent binary 1.

To use a phone modem, you had to first establish a telephone connection between your home computer and a computer that was permanently connected to the Internet. That's where your Internet service provider came in. You paid your ISP a monthly fee for the right to call one of several (preferably local) computers that it had set up for this purpose. Once that connection was made, you could transfer data via your phone lines to your ISP, which then sent it on its way through the Internet backbone. Incoming traffic was routed through your ISP to your home computer.

This approach was fairly simple to implement because it did not require any special effort on the part of the telephone company. Because the data was treated as if it were a voice conversation, no special translation was needed except at either end. But that convenience came at a price. The data transfer rate available with this approach was limited to that of analog voice communication, usually 64 kilobits per second at most.

A phone line can provide a much higher transfer rate if the data is treated as digital rather than analog. A **digital subscriber line (DSL)** uses regular copper phone lines to transfer digital data to and from the phone company's central office. Because DSL and voice communication use different frequencies, it is even possible to use the same phone line for both purposes.

To set up a DSL connection, your phone company may become your Internet service provider, or it may sell the use of its lines to a third-party ISP. To offer DSL service, the phone company must set up special computers to handle the data traffic.

With DSL, there is no need to "dial in" to create the network connection, as with a phone modem. The DSL line maintains an active connection between your home and a computer at the ISP. However, to take advantage of DSL technology, your home must be within a certain distance from the central office; otherwise, the digital signal degrades too much while traveling between those two points.

The most popular option for home connections is a **cable modem**. In this approach, data is transferred on the same line that your cable TV signals come in on. Several leading cable TV companies in North America have pooled their resources to create Internet service providers for cable modem service.

Both DSL connections and cable modems fall into the category of **broadband** connections. Depending on the location and whether access is by satellite, phone wire, video cable, or fiber optics, it is generally defined as being at least 25 megabits per second (Mbps) for downloads. Households have moved away from the use of phone modems to a broadband

### SETI at home (continued)

radio transmissions from extraterrestrial intelligence. The project has millions of participants worldwide, and it is acknowledged by the *Guinness Book of World Records* as the largest computation in history.

**Digital subscriber line (DSL)** An Internet connection made using a digital signal on regular phone lines

**Cable modem** A device that allows computer network communication using the cable TV hookup in a home

**Broadband** Network technologies that generally provide data transfer speeds greater than 25 Mbps

**Download** Receiving data on a local computer from the Internet

**Upload** Sending data from a local computer to a destination on the Internet

**Packet** A unit of data sent across a network

**Packet switching** The approach to network communication in which packets are individually routed to their destination, then reassembled

**Router** A network device that directs a packet between networks toward its final destination

solution for their computing network needs. Debate between the DSL and cable modem communities continues to rage to see who can claim the dominant market share. Both generally provide data transfer speeds in the range of 1.5 to 3 megabits per second.

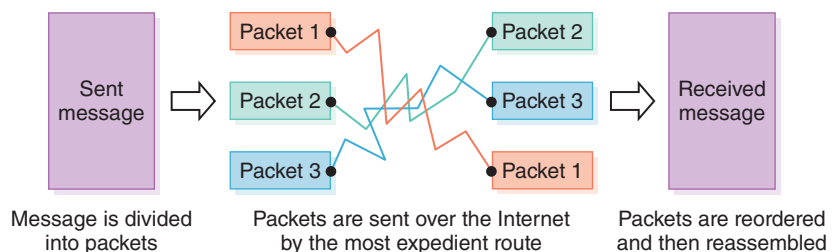
For both DSL and cable modems, the speed for **downloads** (getting data from the Internet to a local computer) is not the same as the speed for **uploads** (sending data from a local computer to the Internet). Most traffic for home Internet users consists of downloads: receiving web pages to view and retrieving data (such as programs and audio and video) stored somewhere else on the network. You perform an upload when you send an email message, submit a web-based form, or request a new web page. Because download traffic dominates upload traffic, many DSL and cable modem suppliers use technology that devotes more speed to downloads.

## Packet Switching

To improve the efficiency of transferring data over a shared communication line, messages are divided into fixed-size, numbered **packets**. These packets are sent over the network individually to their destination, where they are collected and reassembled into the original message. This approach is referred to as **packet switching**.

The packets of a message may take different routes on their way to the final destination. Therefore, they may arrive in a different order than the way they were sent. The packets must be put into the proper order once again and then combined to form the original message. **FIGURE 15.4** illustrates this process.

A packet may make several intermediate hops between computers on various networks before it reaches its final destination. Network devices called **routers** direct the packets as they move between networks. Intermediate routers don't plan out the packet's entire course; each router merely knows the best next step to get it closer to its destination. Eventually a message reaches a router that knows where the destination machine is.



**FIGURE 15.4** Messages sent by packet switching

© Artur Debat/Getty Images; © Alan Dyer/Stocktrek Images/Getty Images

## Doug Engelbart

“Build a better mousetrap, and the world will beat a path to your door. Invent the computer mouse, and the world will all but forget your name.” This was the lead paragraph in an article celebrating the twentieth birthday of the computer mouse.<sup>1</sup>

Designed by Doug Engelbart—the name that was forgotten—and a group of young scientists and engineers at Stanford Research Institute, the computer mouse debuted in 1968 at the Fall Joint Computer conference as part of a demonstration later called “the mother of all demos” by Andy van Dam. The historic demonstration foreshadowed human–computer interaction and networking. It wasn’t until 1981 that the first commercial computer with a mouse was introduced, however. In 1984, the Apple Macintosh brought the mouse into the mainstream. To this day, no one seems to know where the term “mouse” came from.

Engelbart grew up on a farm near Portland, Oregon, during the Depression. He served in the Navy in the Philippines during World War II as an electronics technician. Engelbart completed his electrical engineering degree in 1948 from Oregon State University and moved to the San Francisco Bay Area. In 1955 he received a PhD from the University of California at Berkeley and joined the Stanford Research Institute.

Engelbart’s vision of the computer as an extension of human communication capabilities and a resource for the augmentation of human intellect was outlined in the seminal

paper “Augmenting Human Intellect: A Conceptual Framework,” published in 1962. He never lost this vision.<sup>2</sup>

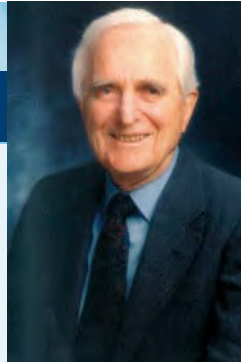
Engelbart felt encouraged by the open-source movement, in which programmers collaborate to create advanced and complicated software. He worked on a system of open software that can be distributed for free over the Internet.

Recognition may have been long in coming, but Engelbart received 32 awards between 1987 and 2001, including the Turing Award in 1997 and the National Medal of Technology in 2000. The citations for these two prestigious awards read as follows:

(Turing Award) For an inspiring vision of the future of interactive computing and the invention of key technologies to help realize this vision.

(National Medal of Technology) For creating the foundations of personal computing including continuous real-time interaction based on cathode-ray tube displays and the mouse, hyper-text linking, text editing, online journals, shared-screen teleconferencing, and remote collaborative work.

Engelbart died in July 2013 at his home in Atherton, California. He was 88.



Courtesy of Doug Engelbart Institute

**Repeater** A network device that strengthens and propagates a signal along a long communication line

**Proprietary system** A system that uses technologies kept private by a particular commercial vendor

**Interoperability** The ability of software and hardware on multiple machines and from multiple commercial vendors to communicate

**Open system** A system that is based on a common model of network architecture and an accompanying suite of protocols

**Open Systems Interconnection (OSI) Reference Model** A seven-layer logical breakdown of network interaction to facilitate communication standards

If a path is blocked due to a down machine, or if a path currently has a lot of network traffic, a router might send a packet along an alternative route.

If a communication line spans a long distance, such as across an ocean, devices called **repeaters** are installed periodically along the line to strengthen and propagate the signal. Recall from Chapter 3 that a digital signal loses information only if it is allowed to degrade too much. A repeater keeps that from happening.

## 15.2 Open Systems and Protocols

Many protocols have been defined to assist in network communication. Some have gained a stronger foothold than others because of many reasons, often historical in nature. This section focuses on the protocols used for general Internet traffic. Before we discuss the details of particular protocols, however, it is important to put them in context by discussing the concept of an open system.

### Open Systems

Early in the development of computer networks, commercial vendors came out with a variety of technologies that they hoped businesses would adopt. The trouble was that these **proprietary systems** were developed with their own particular nuances and did not permit communication between networks of differing types. As network technologies grew, the need for **interoperability** became clear; we needed a way for computing systems made by different vendors to communicate.

An **open system** is one based on a common model of network architecture and a suite of protocols used in its implementation. Open-system architectures maximize the opportunity for interoperability.

The International Organization for Standardization (ISO) established the **Open Systems Interconnection (OSI) Reference Model** to facilitate the development of network technologies. It defines a series of layers of network interaction. **FIGURE 15.5** shows the seven layers of the OSI Reference Model.

Each layer deals with a particular aspect of network communication. The highest level deals with issues that relate most specifically to the application program in question. The lowest layer deals with the most basic electrical and mechanical issues of the physical transmission medium (such as types of wiring). The other layers fill in all other aspects. The network layer, for example, deals with the routing and addressing of packets.

| Number | Layer              |
|--------|--------------------|
| 7      | Application layer  |
| 6      | Presentation layer |
| 5      | Session layer      |
| 4      | Transport layer    |
| 3      | Network layer      |
| 2      | Data Link layer    |
| 1      | Physical layer     |

**FIGURE 15.5** The layers of the OSI Reference Model

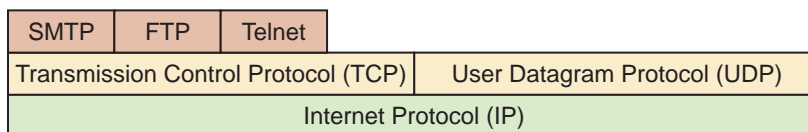
The details of these layers are beyond the scope of this book, but it is important to know that networking technology as we know it today is possible only through the use of open-system technology and approaches such as the OSI Reference Model.

## Network Protocols

**Ethernet** was one of the earliest network protocols (really a family of technologies) that has evolved and become less expensive over time. Most personal computer manufacturers now build Ethernet interfaces directly into the motherboard of the computer, rather than requiring a separate network card.

Ethernet predates the OSI model and originally was tied to a physical and logical bus topology. It has evolved, and it is now more accurate to describe Ethernet as a protocol that spans the Physical and Data Link layers of the OSI reference model.

Following the general concepts of the OSI Reference Model, network protocols are layered such that each one relies on the protocols that underlie it, as shown in **FIGURE 15.6**. This layering is sometimes referred to as a **protocol stack**. The layered approach allows new protocols to be developed



**FIGURE 15.6** Layering of key network protocols

### What is a protocol?

*Protocol* is defined as a code prescribing strict adherence to correct etiquette and procedure (as in a diplomatic exchange). Computing terminology has borrowed the word to describe the correct etiquette for computers to use when communicating with one another.

**Ethernet** A network communication protocol that is integrated into most personal computers

**Protocol stack** Layers of protocols that build and rely on each other



**Transmission Control Protocol (TCP)**

The network protocol that breaks messages into packets, reassembles them at the destination, and takes care of errors

**Internet Protocol (IP)**

The network protocol that deals with the routing of packets through interconnected networks to the final destination

**TCP/IP** A suite of protocols and programs that support low-level network communication

**User Datagram Protocol (UDP)**

An alternative to TCP that achieves higher transmission speeds at the cost of reliability

**Ping** A program used to test whether a particular network computer is active and reachable

without abandoning fundamental aspects of lower levels. It also provides more opportunity for their use, in that the impact of new protocols on other aspects of network processing is minimized. Sometimes protocols at the same level provide the same service as another protocol at that level, but do so in a different way.

A protocol is, in one sense, nothing more than an agreement that a particular type of data will be formatted in a particular manner. The details of file formats and the sizes of data fields are important to software developers who are creating networking programs, but we do not explore those details here. The importance of these protocols is simple to understand: They provide a standard way to interact among networked computers.

The lower two layers in Figure 15.6 form the foundation of Internet communication. Other protocols, sometimes referred to as *high-level protocols*, deal with specific types of network communication. These layers are essentially one particular implementation of the OSI Reference Model and correspond in various ways to the levels described in that model. Let's explore these levels in more detail.

## TCP/IP

TCP stands for **Transmission Control Protocol** and IP stands for **Internet Protocol**. The term **TCP/IP** (pronounced by saying the letters T-C-P-I-P) refers to a suite of protocols and utility programs that support low-level network communication. The term TCP/IP is written to reflect the nature of the protocols' relationship: TCP rests on top of the IP foundation.

IP software deals with the routing of packets through the maze of interconnected networks to their final destination. TCP software breaks messages into packets, hands them off to the IP software for delivery, and then orders and reassembles the packets at their destination. TCP software also deals with any errors that occur, such as if a packet never arrives at the destination.

**UDP** stands for **User Datagram Protocol**. It is an alternative to TCP. That is, UDP software plays the same role as TCP software. The main difference is that TCP is highly reliable, at the cost of decreased performance, whereas UDP is less reliable, but generally faster. UDP is part of the TCP/IP suite of protocols. Because of the heavy reliance on TCP, and for historical reasons, the entire suite is referred to as *TCP/IP*.

An IP program called **ping** can be used to test the reachability of network designations. Every computer running IP software "echoes" ping requests, which makes ping a convenient way to test whether a particular computer is running and can be reached across the network. The term *ping* was chosen to match the term used when submarines send out a sonar pulse and listen for the returned echo. Because ping works at the IP level, it often responds even

when higher-level protocols might not. *Ping* is often used as a verb among network administrators: “Ping computer X to see if it is alive.”

Another TCP/IP utility program called **tracert** shows the route that a packet takes to arrive at a particular destination node. The output of *tracert* is a list of the computers that serve as the intermediate stopping points along the way.

The screenshot in [FIGURE 15.7](#) shows the *tracert* utility in action. It illustrates the hops used for communication between a computer in Florida and a server used by google.com.

**Traceroute** A program that shows the route a packet takes across the Internet

## High-Level Protocols

Other protocols build on the foundation established by the TCP/IP protocol suite. Here are some of the key high-level protocols:

- Simple Mail Transfer Protocol (SMTP)—A protocol used to specify the transfer of electronic mail.
- File Transfer Protocol (FTP)—A protocol that allows a user on one computer to transfer files to and from another computer.
- Telnet—A protocol used to log into a computer system from a remote computer. If you have an account on a particular computer that allows telnet connections, you can run a program that uses the telnet protocol to connect and log in to that computer as if you were seated in front of it.
- Hypertext Transfer Protocol (HTTP)—A protocol defining the exchange of World Wide Web documents, which are typically

```

C:\WINDOWS\System32\cmd.exe
Microsoft Windows XP [Version 5.1.2600]
(C) Copyright 1985-2001 Microsoft Corp.

C:\Documents and Settings\UserName>tracert google.com

Tracing route to google.com [64.233.187.99]
over a maximum of 30 hops:

 0 1 ms <1 ms <1 ms 192.168.1.1
 1 1 ms <1 ms <1 ms GATEWAY1.ORLANDO.dimenoc.com [66.193.174.1]
 2 1 ms 1 ms 1 ms POS4-1.GVS.ORLI.ALTER.NET [63.122.161.105]
 3 1 ms 1 ms 1 ms 500.at-1-1-0.CL2.ORLI.ALTER.NET [152.63.80.102]

 4 15 ms 13 ms 13 ms 0.so-7-0-0.XL2.ATL4.ALTER.NET [152.63.86.109]
 5 13 ms 13 ms 13 ms 0.so-7-0-0.BR1.ATL4.ALTER.NET [152.63.86.173]
 6 15 ms 15 ms 14 ms so-1-1-0.gar2.Atlanta1.Level3.net [4.68.127.177]

 7 16 ms 15 ms 15 ms ae-21-52.car1.Atlanta1.Level3.net [4.68.103.34]

 8 14 ms 16 ms 15 ms 4.78.208.2
 9 15 ms 16 ms 15 ms 66.249.95.125
 10 16 ms 16 ms 19 ms 216.239.49.226
 11 16 ms 16 ms 16 ms 64.233.187.99

Trace complete.

C:\Documents and Settings\UserName>

```

**FIGURE 15.7** The *tracert* utility

Used with permission from Microsoft



?

**Sir Bill?**

Bill Gates, co-founder of the Microsoft Corporation with Paul Allen, is one of the best-known innovators of the PC revolution. He is consistently ranked as one of the world's wealthiest people. After his last full-time day at Microsoft in June 2008, he turned his attention to the Bill and Melinda Gates Foundation—the philanthropic institution he co-founded with his wife—which is currently the largest transparently operated charitable foundation in the world. In 2005, Gates received an honorary knighthood from Queen Elizabeth II in a private ceremony. He was honored for his charitable activities around the world and his contribution to the high-tech enterprise in Great Britain.

**Port** A numeric designation corresponding to a particular high-level protocol

**MIME type** A standard for defining the format of files that are included as email attachments or on websites

written using the Hypertext Markup Language (HTML). HTML is discussed further in Chapter 16.

These protocols all build on TCP. Some high-level protocols have also been defined that build on top of UDP to capitalize on the speed it provides. However, because UDP does not provide the reliability that TCP does, UDP protocols are less popular.

Several high-level protocols have been assigned a particular *port* number. A **port** is a numeric designation that corresponds to a particular high-level protocol. Servers and routers use the port number to help control and process network traffic. **FIGURE 15.8** lists common protocols and their ports. Some protocols, such as HTTP, have default ports but can use other ports as well.

## MIME Types

Related to the idea of network protocols and standardization is the concept of a file's **MIME type**. MIME stands for *Multipurpose Internet Mail Extension*. Although MIME types do not define a network protocol, they define a standard for attaching or including multimedia or otherwise specially formatted data with other documents, such as email.

Based on a document's MIME type, an application program can decide how to deal with the data it is given. For example, the program you use to read email may examine the MIME type of an email attachment to determine how to display it (if it can).

MIME types have been defined for the documents created by many common application programs, as well as for data from particular con-

| Protocol                              | Port |
|---------------------------------------|------|
| Echo                                  | 7    |
| File Transfer Protocol (FTP)          | 21   |
| Telnet                                | 23   |
| Simple Mail Transfer Protocol (SMTP)  | 25   |
| Domain Name Service (DNS)             | 53   |
| Gopher                                | 70   |
| Finger                                | 79   |
| Hypertext Transfer Protocol (HTTP)    | 80   |
| Post Office Protocol (POP3)           | 110  |
| Network News Transfer Protocol (NNTP) | 119  |
| Internet Relay Chat (IRC)             | 6667 |

**FIGURE 15.8** Some protocols and the ports they use

tent areas. Chemists and chemical engineers, for example, have defined a large set of MIME types for various types of chemical-related data.

## Firewalls

A **firewall** is a machine and its software that serve as a special gateway to a network, protecting it from inappropriate access. A firewall filters the network traffic that comes in, checking the validity of the messages as much as possible and perhaps denying some messages altogether. The main goal of a firewall is to protect (and, to some extent, hide) a set of more loosely administered machines that reside “behind” it. This process is pictured in

FIGURE 15.9

A firewall enforces an organization’s **access control policy**. For example, a particular organization may allow network communication only between its users and the “outside world” via email, but deny other types of communication, such as accessing websites. Another organization may allow its users to freely access the resources of the Internet, but may not want general Internet users to be able to infiltrate its systems or gain access to its data.

The system administrators of an organization set up a firewall for their LAN that permits “acceptable” types of communication and denies

**Firewall** A gateway machine and software that protects a network by filtering the traffic it allows

**Access control policy** A set of rules established by an organization that specify which types of network communication are permitted and denied

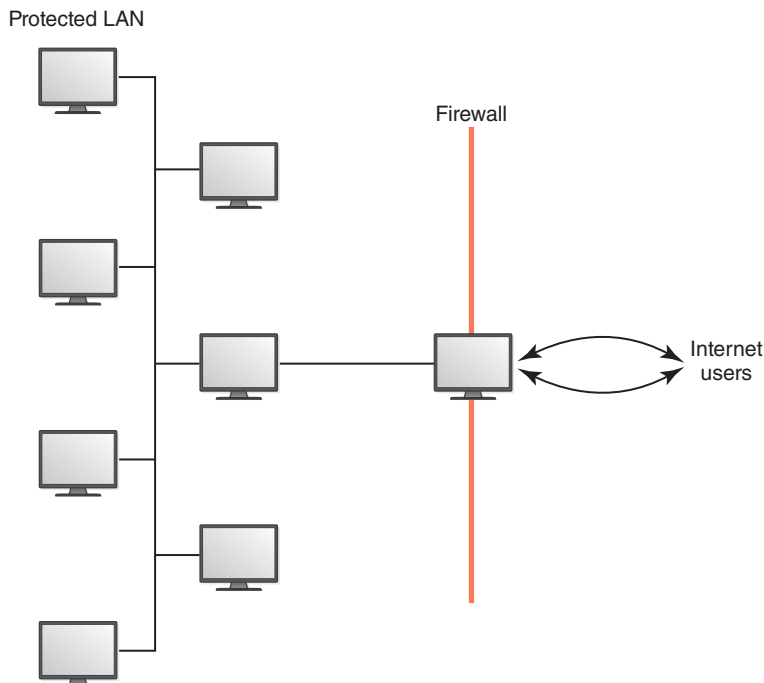


FIGURE 15.9 A firewall protecting a LAN

other types. This policy can be implemented in a variety of ways, although the most straightforward approach is to deny traffic on particular ports. For example, a firewall could be set up to deny a user outside the LAN the ability to create a telnet connection to any machine inside the LAN by denying all traffic that comes in on port 23.

More sophisticated firewall systems may maintain internal information about the state of the traffic passing through them and/or the content of the data itself. The more a firewall can determine about the traffic, the more able it is to protect its users. Of course, this security comes at a price. Some sophisticated firewall approaches might create a noticeable delay in network traffic.

A firewall is a low-level network communication mechanism. There are many other issues related to the security of information that every user should know as well. These issues are discussed in Chapter 17.

## 15.3 Network Addresses

When you communicate across a computer network, you ultimately communicate with one particular computer out of all possible computers in the world. There is a fairly sophisticated mechanism for identifying specific machines to establish that communication.

A **hostname** is a unique identification that specifies a particular computer on the Internet. Hostnames are generally readable words separated by dots. For example:

```
matisse.csc.villanova.edu
condor.develocorp.com
```

We humans prefer to use hostnames when dealing with email addresses and websites because they are easy to use and remember. Behind the scenes, however, network software translates a hostname into its corresponding **IP address**, which is easier for a computer to use. An IP address can be represented as a series of four decimal numbers separated by dots. For example:

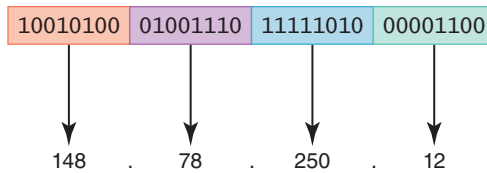
```
205.39.155.18
193.133.20.4
```

One form of IP address is stored in 32 bits and referred to as *IPv4*. Each number in an IP address corresponds to one byte in the IP address. Because one byte (8 bits) can represent 256 things, each number in an IP address is in the range of 0 to 255. See **FIGURE 15.10**. The addressing scheme is hierarchical, with the first two numbers representing the network, the third representing the subnetwork, and the last representing the particular host machine.

A major problem with the IPv4 strategy is that it is limited in the number of unique computers (around four billion) it could identify. As Internet use increased, especially with the popularity of mobile computing

**Hostname** A name made up of words separated by dots that uniquely identifies a computer on the Internet; each hostname corresponds to a particular IP address

**IP address** An address made up of numeric values separated by dots that uniquely identifies a computer on the Internet



**FIGURE 15.10** An IP address stored in four bytes

devices such as smartphones and tablets, the supply of unique 4-byte IP addresses dwindled. In early 2011, the last block of IPv4 addresses was assigned.

IPv6 is the successor to IPv4. Instead of using 32 bits, organized in four groups of eight, IPv6 addresses use 128 bits, organized in eight groups of 16. An IPv6 address is usually written using hexadecimal digits to keep the length manageable. For example:

FE80:0000:0000:0202:B3FF:FE1E:8329

In addition to providing many more addresses, the IPv6 protocol provides several additional features that improve the management of network traffic. IPv6 operates in parallel with IPv4 addressing, creating essentially two parallel networks.

## Domain Name System

A hostname consists of the computer name followed by the **domain name**. For example, in the hostname

`matisse.csc.villanova.edu`

`matisse` is the name of a particular computer, and `csc.villanova.edu` is the domain name. A domain name is separated into two or more sections that specify the organization, and possibly a subset of an organization, of which the computer is a part. In this example, `matisse` is a computer in the Department of Computing Sciences at Villanova University.

The domain names narrow in on a particular set of networks controlled by a particular organization. Note that two organizations (or even suborganizations) can have a computer named the same thing because the domain name makes it clear which one is being referred to.

The very last section of the domain is called its **top-level domain (TLD)** name. [FIGURE 15.11](#) lists some of the primary top-level domains. Some TLDs (noted by asterisks in Figure 15.11) have been around since the Internet was first established; others are relatively recent additions.

**ICANN**, which stands for *Internet Corporation for Assigned Names and Numbers*, is the international authority that manages TLD names.

**Domain name** The part of a hostname that specifies a specific organization or group

**Top-level domain (TLD)** The last section of a domain name, specifying the type of organization or its country of origin

**ICANN** The international organization that approves top-level domain names

| Top-Level Domain | General Purpose                       |
|------------------|---------------------------------------|
| .aero            | Aerospace industry                    |
| .biz             | Business                              |
| .com*            | U.S. commercial (unrestricted)        |
| .coop            | Cooperative                           |
| .edu*            | U.S. educational                      |
| .gov*            | U.S. government                       |
| .info            | Information (unrestricted)            |
| .int*            | International organizations           |
| .jobs            | Employment                            |
| .mil*            | U.S. military                         |
| .museum          | Museums                               |
| .name            | Individuals and families              |
| .net*            | Network (unrestricted)                |
| .org*            | Nonprofit organization (unrestricted) |
| .pro             | Certain professions                   |

**FIGURE 15.11** Some top-level domains and their general purpose (\* indicates an original TLD)

A TLD generally indicates a particular type of organization, such as **.com** for commercial businesses and **.edu** for colleges and universities. Some TLDs (such as **.edu**) are carefully controlled, with registration restricted to only bona fide organizations of a particular type. Other TLDs are unrestricted in that sense. Organizations based in countries other than the United States often use a top-level domain that corresponds to their two-letter country codes. Some of these codes (there are hundreds of them) are listed in [FIGURE 15.12](#).

The unrestricted nature of the **.com**, **.org**, and **.net** TLDs initially allowed anyone or any organization to register a domain name for its own use as long as that name hadn't already been taken. As the Internet expanded, this naming system became a problem. Newcomers to the Internet lamented that the best domain names had already been taken. Sometimes a name had already been claimed by another similar organization. In other cases people tried to claim as many popular names as possible, hoping to sell (some would say ransom) them to large corporations.

This practice is called **domain squatting**, and is generally considered unethical. To alleviate this problem, additional top-level domains have been

#### Domain squatting

Purchasing a domain name with the sole intent of selling it at a high price to a person or organization that actually wants to use it

| Country Code TLD | Country            |
|------------------|--------------------|
| .au              | Australia          |
| .br              | Brazil             |
| .ca              | Canada             |
| .gr              | Greece             |
| .in              | India              |
| .ru              | Russian Federation |
| .uk              | United Kingdom     |

**FIGURE 15.12** Some of the top-level domain names based on country codes

approved and made available over time. The ability to register a domain name using one of the newer TLDs has been somewhat controlled, giving preference to organizations that hold trademarks on particular names.

In 2011, the pressure for more domain options led ICANN to approve a program to greatly expand the number of generic TLDs. Companies and organizations were allowed to submit applications for potential new TLDs.

Some of the TLDs are controlled by particular corporate brands, but others are available for general use. There are now more than 1,500 TLDs available.

Here is a very small, random selection of TLDs that are available:

|           |            |        |             |            |
|-----------|------------|--------|-------------|------------|
| social    | furniture  | dental | paris       | media      |
| career    | town       | rocks  | cooking     | rodeo      |
| nyc       | trade      | webcam | vote        | actor      |
| vacations | industries | wiki   | productions | flights    |
| rentals   | catering   | dating | bargains    | cool       |
| pics      | guitars    | tax    | dance       | email      |
| farm      | education  | ninja  | coffee      | shoes      |
| menu      | kitchen    | land   | support     | associates |
| institute | camp       | center | directory   | florist    |

A full list of the names and their availability can be found at: [www.iana.org/domains/root/db](http://www.iana.org/domains/root/db). IANA is a department of ICANN.

The **domain name system** (DNS) is chiefly used to translate hostnames into numeric IP addresses. Before the DNS system was established, a

**Domain name system** A distributed system for managing hostname resolution

**Domain name server**

A computer that attempts to translate a hostname into an IP address

Stanford research group maintained a single file known as the *host table*. As new hostnames were established, the Stanford group would add them to the table (usually twice a week). System administrators would retrieve the revised host table occasionally to update their **domain name servers**, which are computers that translate (resolve) a hostname into its IP address.

As the number of hostnames grew, the single-table approach became unreasonable. It simply wasn't a practical way to update and distribute the information. In 1984, network engineers designed the more sophisticated domain name system that is in use today. DNS is an example of a distributed database; no one organization is responsible for updating the hostname/IP mappings.

When you specify a hostname in a browser window or email address, the browser or email software sends a request to a nearby domain name server. If that server can resolve the hostname, it does so. If not, that server asks another domain name server for help. If the second server can't resolve it, the request continues to propagate. Ultimately, either the request reaches a server that can resolve the name or the request expires because it took too much time to resolve.

## Who Controls the Internet?

These are interesting times for the Internet. Two recent developments, in particular, may have significant impacts on its use.

The Internet began as the ARPANET, a project of the U.S. Department of Defense. Initially, the United States explicitly controlled the assignment and management of IP addresses and domain names. In 1998, those responsibilities were subcontracted to ICANN, an international nonprofit organization, but the United States remained the dominant player.

In March 2014, the U.S. government announced that it will reduce its role in this process. It was widely expected that the United States would eventually decrease its role, but that effort was spurred forward by revelations that U.S. intelligence agencies such as the NSA have been intercepting Internet traffic.

As you can imagine, there is great concern across the globe about how exactly this new governing organization will work. Many voices from around the world will vie to be heard as these important decisions are made.

Another Internet-related issue comes from a recent plan suggested by the Federal Communications Commission (FCC) to allow ISPs to

## ?

**Missed opportunity**

In 1976, an engineering intern working for Hewlett-Packard built a prototype for a personal computer. He offered it to HP, but they turned it down and gave him rights to the product. The intern was Stephen Wozniak. The machine was the first Apple Computer that he and Steve Jobs manufactured in their garage.<sup>4</sup>

provide “premium” access to certain customers. Currently, no distinction is made between customers. Information is transmitted to everyone as fast as the technology allows. The new plan would allow ISPs to transfer data at higher speeds to those who pay for the privilege, perhaps by deliberately slowing down data transfer to those who don’t.

At the heart of this argument is the concept of **network neutrality**, which prohibits playing favorites among Internet consumers. This topic has become highly politicized, and how it plays out will have a significant impact on the use of the Internet.

## 15.4 Cloud Computing

We introduced the idea of cloud computing in Chapter 1. **Cloud computing** is a paradigm in which computing system resources (computing power, storage space, etc.) are provided by a third party and managed through Internet communication.

The term *cloud computing* comes from diagrams, like [FIGURE 15.13](#), that show network communication going through an amorphous cloud to get to a resource. The point is that we don’t necessarily know or care where the resource is or how the communication gets routed; we just want the resource.

You may already use the concept of cloud computing on a small scale with an email account. For example, an email service such as Google’s Gmail stores and manages your email on its network servers. When you use a browser or other email client to access your email, it’s downloaded onto your computer or mobile device. That way, you don’t have to worry about what computer you’re using or where you are when you access it.

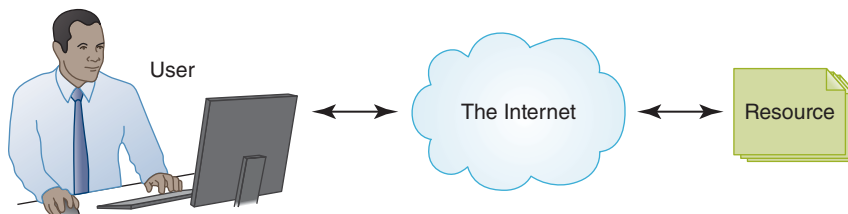
Cloud computing takes that concept to a larger scale. A business or individual can store not just email but also documents, images, videos, etc. on network servers instead of a local machine. The benefits of this approach are that the management of the devices on which this

### Network neutrality

The principle that ISPs should deliver data to everyone equally, as fast as the technology allows

### Cloud computing

A paradigm in which computing system resources are provided by a third party and managed through Internet communication



**FIGURE 15.13** Internet communication depicted using a cloud



**Gaming can be dangerous**

In 2005, a South Korean man died after reportedly playing video games for 50 hours straight. In 2012, a Taiwanese man was discovered dead in his gaming chair, killed by a heart attack, arms still outstretched toward his computer.<sup>3</sup> Although not normally a direct cause of immediate death, video game addiction can lead to premature death due to the sedentary lifestyle it promotes and the unhealthy effects that result.

**Blockchain** An incorruptible public ledger of transactions.

information is stored is largely left to someone else, and that it is available wherever an Internet connection can be found.

Cloud services usually provide other benefits as well. A cloud service typically makes backups of your data, relieving you of that responsibility. Some provide web hosting capabilities as part of their service. Some support synchronization services that keep things like browser bookmarks in sync on multiple devices automatically.

Cloud computing has become a standard mode of operation for many businesses. It relieves the business of potentially expensive hardware and software resources, as well as the personnel needed to manage the data in house. The dominant providers of cloud computing are Amazon Web Services, Google Cloud, and Microsoft Azure.

There are different types of cloud services available:

- **Public cloud**—accessible by any subscriber
- **Private cloud**—established for a specific group or organization, limiting access to that group
- **Community cloud**—shared among two or more organizations with similar needs
- **Hybrid cloud**—some combination of the above cloud types

Some cloud services are free, and services that charge a fee vary in cost significantly. If you're interested in cloud computing, research your options carefully.

## 15.5 Blockchain

**Blockchain** is a network-based technology that was originally developed to support Bitcoin, a cryptocurrency that has been in use since 2009. A *cryptocurrency* is a currency that exists only in the digital world, instead of as paper money or some other physical representation. But the importance of blockchain is spreading beyond cryptocurrency; many think that it represents the future of online transactions.

Blockchain is like a public ledger, recording important data about economic transactions. Although originally designed for financial transactions, it can be used to record anything of value, such as contracts, medical data, or voting records.

A *block* is a record of new transactions. Once verified using established algorithms and encryption technology, a transaction is added to a block, and the block is added to the chain of ongoing sequential transactions (the blockchain).

One reason blockchain technology is so exciting is that the record of transactions is considered incorruptible. The ledger of transactions is decentralized—that is, it's not stored in only one place, but across the Internet on many computers. It is also self-auditing: Every ten minutes, the ledger is reconciled across the network. Therefore, there is no single point of failure; no centralized version of the information exists that a hacker could corrupt. It cannot be controlled by any single entity.

Blockchain creates the ability to bypass traditional entities involved in these transactions, such as banks or even governments.

It is also thought that blockchain may have a significant impact on the economic status of people around the world. Just as anyone can have a voice on the Internet, blockchain promises to empower people economically, allowing anyone to register property rights, for instance, who wouldn't otherwise have access to such services.

© Artur Debat/Getty Images, © Alan Dyer/Stocktrek Images/Getty Images

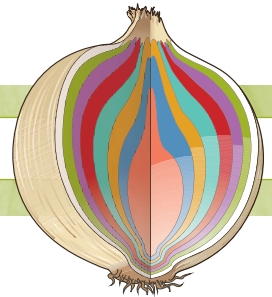
## SUMMARY

A network is a collection of computers connected to share resources and data. Network technologies must concern themselves with underlying protocols and data transfer speeds. The client/server model has emerged as an important software technology given our ever-increasing reliance on networks.

Networks are often classified by their scope. A local-area network (LAN) covers a small geographic area and a relatively small number of connected devices. A wide-area network (WAN) embraces the concept of internetworking, connecting one network to another, and covers a large geographic area. A metropolitan-area network (MAN) is specially designed for large cities. LAN topologies include ring, star, and bus networks. Ethernet has become a standard topology for local-area networks.

Open systems are based on a common model of network architecture and protocols, allowing for interoperability. The OSI Reference Model is a seven-layer description of network processing based on open-system principles.

The Internet backbone is a set of high-speed networks provided by various companies. Internet service providers (ISPs) connect to the backbone or to other ISPs and provide connections for both home and business computing. Home connection technologies include phone modems, digital



subscriber lines (DSL), and cable modems. Phone modems transfer data as audio signals and, therefore, are quite slow. DSL uses the same phone lines but transfers data digitally. Cable modems are also digital but use cable TV wiring to transfer data.

Messages are transferred over the Internet by breaking them up into packets and sending those packets separately to their destination, where they are reassembled into the original message. Packets may make several intermediate hops between networks before arriving at their destination. Routers are network devices that guide a packet between networks. Repeaters strengthen digital signals before they degrade too much.

Network protocols are layered so that a high-level protocol relies on lower-level protocols that support it. The key lower-level protocol suite for Internet traffic is TCP/IP. IP protocols and software deal with the routing of packets. TCP protocols and software divide messages into packets, reassemble them at the destination, and handle any errors that occur. High-level protocols include SMTP for email traffic, FTP for file transfers, telnet for remote login sessions, and HTTP for web traffic. Several high-level protocols have been assigned port numbers, which are used to help control and process network traffic. MIME types have been defined for many types of documents and special data formats.

A firewall protects a network from inappropriate access and enforces an organization's access control policy. Some firewalls simply block traffic on specific ports; other, more sophisticated firewalls analyze the content of network traffic.

An Internet network address must pinpoint a particular machine among all possible ones in the world. A hostname uses readable words separated by dots. A hostname is translated into an IP address, which is a numeric address separated into four sections. One part of the IP address identifies the network, and another part identifies the specific host on that network. How the IP address is broken down depends on the network class (A, B, or C) that the address references.

The domain name system (DNS) translates hostnames into IP addresses. DNS has evolved from using a single file containing all of the information into a distributed system dividing the responsibility among millions of domain name servers. Top-level domains, such as `.com` and `.edu`, have become crowded, so some new top-level domains, such as `.info` and `.biz`, have been approved.

Cloud computing is a service that provides storage space and other resources on the Internet, largely freeing you from the responsibility of managing data and making it available wherever you are. There are various types of cloud services available at varying costs.



## ETHICAL ISSUES

### The Effects of Social Networking<sup>5,6</sup>

Social networking sites such as Facebook, Twitter, Instagram, and LinkedIn are a primary communication medium for many people. Students, parents, businesses, celebrities—and yes, even presidential candidates—are using these sites. People use social networking to stay in touch with family, friends, and colleagues and to update others on events in their lives.

By September 2013, 73% of online adults were using social networking sites. In 2011, 95% of U.S. teenagers between the ages of 12 and 17 were using the Internet, and 81% of them were using social networks. By 2017, 81% of *all* U.S. citizens had a social media profile.

Celebrities often use Twitter as a way of reaching out to the general public, tweeting information about their television shows' upcoming guests, new projects, or their favorite books or recipes. During the 2012 U.S. presidential race, President Barack Obama and Governor Mitt Romney changed the face of politics with their use of social media, and the 2016 presidential election saw Donald Trump use Twitter in ways no politician ever had.

The popularity of social networking sites has helped many, especially teenagers, to bridge social gaps. Teens who might normally be quite introverted can commu-

nicate through social networking and reach out to more peers. Social networking has made a huge difference for college students as well, who can connect with more than just the students whom they happen to meet in class. These sites are also a popular way to advertise parties, meetings, concerts, and other events that are taking place, so more students are aware of campus events and social gatherings.

There are, of course, downsides to any social media, and networking sites are no exception. For example, the information put on the sites may not be accurate. Social networking sites can be prime avenues for online humiliation and bullying, or *cyberbullying*. One in four teenagers has admitted to being cyberbullied. A new survey indicates that teenagers who spend more time on social networks are more likely to also develop addictions to alcohol or smoking. This finding does not confirm cause and effect, but it is worrisome.

A deeper question is this: Do the benefits of social networking outweigh the potential costs? These sites give people a much easier way to communicate, keep in touch with friends, and get important messages out to large groups of people. But users must be aware of the personal risks they are taking by participating in these forums.

**KEY TERMS**

Access control policy  
Blockchain  
Broadband  
Bus topology  
Cable modem  
Client/server model  
Cloud computing  
Computer network  
Data transfer rate (bandwidth)  
Digital subscriber line (DSL)  
Domain name  
Domain name server  
Domain name system  
Domain squatting  
Download  
Ethernet  
File server  
Firewall  
Gateway  
Host number  
Hostname  
ICANN  
Internet  
Internet backbone  
Internet Protocol (IP)  
Internet service provider (ISP)  
Interoperability  
IP address  
Latency  
Local-area network (LAN)  
Metropolitan-area network (MAN)  
MIME type  
Network address  
Node (host)  
Open system  
Open Systems Interconnection (OSI)  
Reference Model  
Packet  
Packet switching  
Phone modem  
Ping  
Port  
Proprietary system  
Protocol  
Protocol stack  
Repeater  
Ring topology  
Router  
Star topology  
TCP/IP  
Top-level domain (TLD)  
Traceroute  
Transmission Control Protocol (TCP)  
Upload  
User Datagram Protocol (UDP)  
Web server  
Wide-area network (WAN)  
Wireless

## EXERCISES

For Exercises 1–6, match the word or acronym with the definition or the appropriate blank.

- A. LAN
- B. WAN
- C. Gateway
- D. Bus topology
- E. Ethernet
- F. Internet

1. The Internet is a \_\_\_\_\_.
2. The industry standard for LANs.
3. A node that handles communication between its LAN and other networks.
4. A network that connects other networks.
5. Star topology is a \_\_\_\_\_ configuration.
6. Ethernet uses \_\_\_\_\_.

For Exercises 7–15, match the word or acronym with the definition or the appropriate blank.

- A. DSL
- B. TCP/IP
- C. UDP
- D. IP
- E. TCP
- F. Broadband

7. \_\_\_\_\_ and voice communication can use the same phone line.
8. DSL and cable modems are \_\_\_\_\_ connections.
9. An Internet connection made using a digital signal on regular phone lines.
10. Network technologies that generally provide data transfer speeds greater than 25 Mbps.
11. The network protocol that breaks messages into packets, reassembles the packets at the destination, and takes care of errors.
12. The suite of protocols and programs that supports low-level network communication.
13. An alternative to TCP that achieves higher transmission speeds.
14. Software that deals with the routing of packets.
15. \_\_\_\_\_ has more reliability than UDP.

For Exercises 16–20, match the protocol or standard with what it specifies or defines.

- A. SMTP
- B. FTP
- C. Telnet
- D. HTTP
- E. MIME type

16. Transfer of electronic mail.
17. Log in to a remote computer system.
18. Transfer files to and from another computer.
19. Format of email attachments.
20. Exchange of World Wide Web documents.

For Exercises 21–28, mark the answers true or false as follows:

- A. True
- B. False

21. A P2P network establishes a single portal through which communication is managed.
22. A port is a numeric designation that corresponds to a particular high-level protocol.

**EXERCISES (CONTINUED)**

23. A firewall protects a local-area network from physical damage.
  24. Each company can establish its own access control policy.
  25. A TV cable company cannot also be an Internet service provider.
  26. Some top-level domains are based on the country in which the registering organization is based.
  27. There are now hundreds of top-level domains in the domain name system.
  28. Two organizations cannot have the same name for a computer.
- Exercises 29–67 are problems or short-answer questions.
29. What is a computer network?
  30. How are computers connected together?
  31. To what does the word *node (host)* refer?
  32. Name and describe two key issues related to computer networks.
  33. What is a synonym for *data transfer rate*?
  34. Describe the client/server model and discuss how it has changed how we think about computing.
  35. What is a P2P network?
  36. Just how *local* is a local-area network?
  37. Distinguish between the following LAN topologies: ring, star, and bus.
  38. How does the shape of the topology influence message flow through a LAN?
  39. What is a MAN, and what makes it different from a LAN and a WAN?
  40. Distinguish between the Internet backbone and an Internet service provider (ISP).
  41. Name and describe three technologies for connecting a home computer to the Internet.
  42. What role do ISPs play with the three technologies in Exercise 41?
  43. What are the advantages and disadvantages of each of the technologies in Exercise 41?
  44. Phone modems and digital subscriber lines (DSL) use the same kind of phone line to transfer data. Why is DSL so much faster than phone modems?
  45. Why do DSL and cable modem suppliers use technology that devotes more speed to downloads than to uploads?
  46. Messages sent across the Internet are divided into packets. What is a packet, and why are messages divided into them?
  47. Explain the term *packet switching*.
  48. What is a router?
  49. What is a repeater?
  50. What problems arise due to packet switching?
  51. What are proprietary systems, and why do they cause a problem?
  52. What do we call the ability of software and hardware on multiple

**EXERCISES (CONTINUED)**

- platforms from multiple commercial vendors to communicate?
53. What is an open system, and how does it foster interoperability?
  54. Compare and contrast proprietary and open systems.
  55. What is the seven-layer logical breakdown of network interaction called?
  56. What is a protocol stack, and why is it layered?
  57. What is a firewall, what does it accomplish, and how does it accomplish it?
  58. What is a hostname, and how is it composed?
  59. Why was the IPv6 protocol created for IP addresses?
  60. What is the primary difference between the IPv4 and IPv6 protocols?
  61. What is a domain name?
  62. What is a top-level domain name?
  63. What is network neutrality?
  64. How does the current domain name system try to resolve a hostname?
  65. What is cloud computing?
  66. Compare cloud computing to an email service such as Gmail.
  67. What are the four types of cloud computing services?
  68. What is blockchain?

**THOUGHT QUESTIONS**

1. What networking facilities have been set up at your school? Are there any restrictions?
2. If you wanted to register a domain name, how would you go about it? *.biz*, *.info*, *.pro*, *.museum*, *.aero*, and *.coop* are top-level domain names. Are there any current restrictions on the use of these top-level domain names?
3. Do you think that the term *Internet* is appropriate? Would *Intranet* be a better name?
4. How many social networking sites do you use regularly? What abuses of the technology have you seen?
5. In your opinion, does the good side of social networking sites outweigh the bad?



## Laying the Groundwork

- 1 The Big Picture

## The Information Layer

- 2 Binary Values and Number Systems
- 3 Data Representation

## The Hardware Layer

- 4 Gates and Circuits
- 5 Computing Components

## The Programming Layer

- 6 Low-Level Programming Languages and Pseudocode
- 7 Problem Solving and Algorithms
- 8 Abstract Data Types and Subprograms
- 9 Object-Oriented Design and High-Level Programming Languages

## The Operating Systems Layer

- 10 Operating Systems
- 11 File Systems and Directories

## The Applications Layer

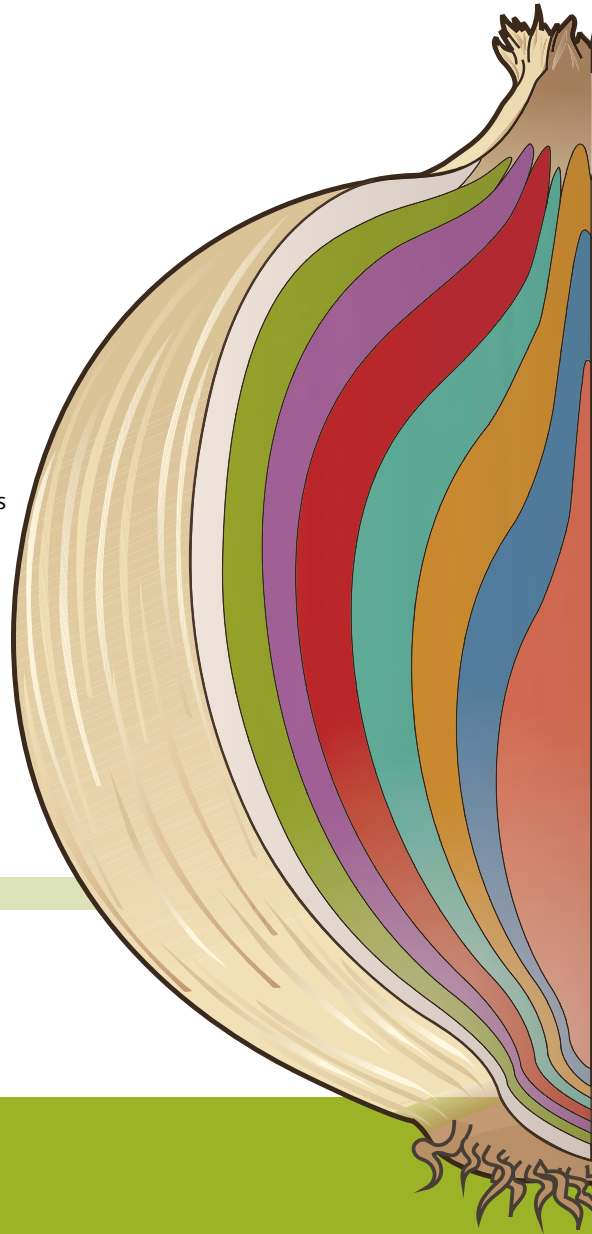
- 12 Information Systems
- 13 Artificial Intelligence
- 14 Simulation, Graphics, Gaming, and Other Applications

## The Communications Layer

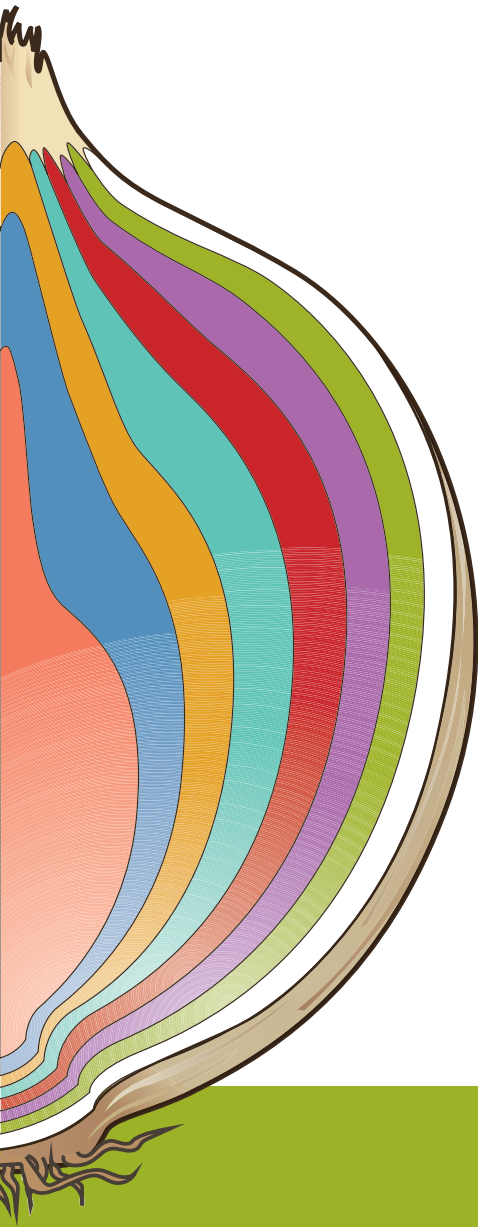
- 15 Networks
- 16 The World Wide Web
- 17 Computer Security

## In Conclusion

- 18 Limitations of Computing



# THE COMMUNICATIONS LAYER



## 16

# THE WORLD WIDE WEB

The evolution of the World Wide Web has made network communication a convenient reality for many users who would otherwise avoid computers completely. As the name implies, the Web has created spider-like connections across the entire planet, forming an infrastructure of information and resources, and making them available at the click of a mouse button. Several different underlying technologies make the Web the productive tool it is today. This chapter explores a few of them and establishes a foundation of web-based principles on which all future technologies likely will rely.

## GOALS

After studying this chapter, you should be able to:

- compare and contrast the Internet and the World Wide Web.
- describe general web processing.
- write basic HTML documents.
- describe several specific HTML tags and their purposes.
- describe the processing of Java applets and Java server pages.
- compare and contrast HTML and XML.
- define basic XML documents and their corresponding DTDs.
- explain how XML documents are viewed.

## 16.1 Spinning the Web

Many people use the words *Internet* and *Web* interchangeably, but in reality they are fundamentally different. The details of computer networks were discussed in Chapter 15. Networks have been used to connect computers since the 1950s. Communication via the Internet has been possible for many years, but in the early days that communication was almost exclusively accomplished via text-based email and basic file exchanges.

Compared to the Internet, the **World Wide Web** (or simply the **Web**) is a relatively new idea. The Web is an infrastructure of distributed information combined with software that uses networks as a vehicle to exchange that information. A **web page** is a document that contains or references various kinds of data, such as text, images, graphics, and programs. Web pages also contain **links** to other web pages so that the user can “move around” as desired using the point-and-click interface provided by a computer mouse. A **website** is a collection of related web pages, usually designed and controlled by the same person or company.

The Internet makes the communication possible, but the Web makes that communication easy, more productive, and more enjoyable. Although universities and some high-tech companies had been using the Internet for years, it wasn’t until the mid-1990s, when the World Wide Web was developed, that the Internet became a household name. Suddenly, Internet service providers (ISPs) began springing up everywhere, allowing people to connect to the Internet from their homes. The Internet, largely because of the World Wide Web, is now a primary vehicle for business. Electronic shopping, financial transactions, and group management are all common online activities. The Web has literally changed the way we conduct our personal and business lives.

When we use the Web, we often talk about “visiting” a website, as if we were going there. In truth, we actually specify the resource we want, and it is brought to us. The concept of visiting a site is understandable in that we often don’t know what’s at a particular site until we “go to it” and see.

We communicate on the Web using a **web browser**, such as Firefox or Google Chrome. A web browser is a software tool that issues the request for the web page we want and displays it when it arrives. **FIGURE 16.1** depicts this process.

The requested web page is usually stored on another computer, which may be down the hall or halfway around the world. The computer that is set up to respond to web requests is called a **web server**.

### World Wide

**Web (Web)** An infrastructure of information and the network software used to access it

### Web page

A document that contains or references various kinds of data

### Link

A connection between one web page and another

### Website

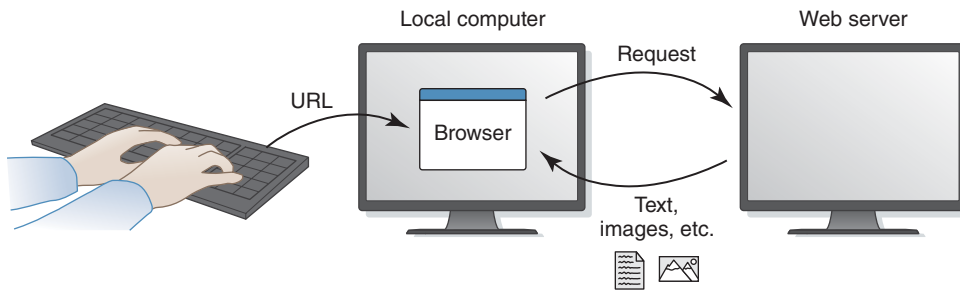
A collection of related web pages, usually designed and controlled by the same person or company

### Web browser

A software tool that retrieves and displays web pages

### Web server

A computer set up to respond to requests for web pages



**FIGURE 16.1** A browser retrieving a web page

In a browser, we specify the web page we want by using a web address such as

`www.villanova.edu/academics.html`

A web address is the core part of a **Uniform Resource Locator (URL)**, which uniquely identifies the page you want out of all of the pages stored anywhere in the world. Note that part of a URL is the hostname of the computer on which the information is stored. Chapter 15 discussed hostnames and network addresses in detail.

In addition to text, a web page often consists of separate elements such as images. All elements associated with a particular web page are brought over when a request for that web page is made.

Various technologies contribute to the design and implementation of a website. Our goal in this chapter is to introduce you to a few of these technologies. More detail about these topics can be found on this book's own website.

## Search Engines

A web *search engine* is a site that helps you find other websites. You probably use a search engine, such as Google, Bing, or Yahoo!, every day. When you enter keywords that indicate the type of information you're looking for, the search engine provides a list of links to potential sites.

A search engine produces its list of candidate sites by searching a database containing information about millions of websites. A good search engine keeps its database up to date and has effective techniques for matching the keywords to the content of a web page.

Most search engines compare the keywords entered by the search engine user to a set of keywords that have been indexed about each website. Some search engines index almost every word on every web page in

### Uniform Resource Locator (URL)

A standard way of specifying the location of a web page



### The dancing spiders of Google

A high search ranking on Google is essential for online businesses. Google updates its ranking using spider “bots”—search programs that “crawl” through more than 1 trillion unique URLs in sweeps known as “Google dances.” Firms that specialize in search-engine optimization (SEO) help online businesses maintain high search rankings by making adjustments to their clients’ websites that are valued by Google’s spider bots. The best SEOs can improve their clients’ search rankings dramatically. In contrast, companies that employ overly aggressive techniques, such as keyword stuffing, might get their websites banned from the search results.

**Instant messaging** A technique for sending short messages in real time

their databases, usually eliminating common words such as “a,” “an,” and “the.” Other search engines index only part of a page, such as the document’s title and headings. Some indexing techniques are case sensitive; others are not.

Keyword searching is challenging to do effectively because natural languages such as English are inherently ambiguous (this issue was discussed in Chapter 13 as well). For example, the terms *hard cider*, *hard brick*, *hard exam*, and *hard drive* all use the word “hard” in different ways. If enough keywords are provided, the search engines will ideally prioritize the matches appropriately. Without context, however, the utility of basic keyword matching is limited.

Some search engines perform *concept-based searches*, which attempt to figure out the context of your search. When they work well, they return candidate pages that contain content that relates to your search topic, whether or not the words in the page match the keywords in the query exactly.

Several techniques are employed for performing concept-based searches. They generally rely on complex linguistic theories that are beyond the scope of this book. The basic premise is called *clustering*, which compares words to other words found in close proximity. For example, the word *heart*, used in a medical sense, may be near words like *artery*, *cholesterol*, and *blood*.

Concept-based searches are far more complicated than keyword searches, and concept-based techniques have not been perfected. Nevertheless, they have far more potential to be effective once these techniques improve.

## Instant Messaging

**Instant messaging** (IM) technology allows users to send short messages in real time. If both the sender and receiver(s) have an active messaging application running, the messages pop up immediately, allowing two or more people to have an ongoing conversation.

IM differs from texting in a couple of ways. Texting is done exclusively with phones and sent to a recipient based on a telephone number. Instant messages are sent to a recipient based on a username registered with the IM application. IM applications can be run on laptop and desktop computers as well as smartphones. Some IM applications allow multiple users to participate in the same conversation using a *chat room*.

Many IM applications allow the user to set up contact lists and default replies (when not logged on), as well as send custom graphics. Most use a

proprietary protocol that dictates the precise format and structure of the messages sent across the network.

Instant messaging, though convenient, is not secure. The messages sent through the various IM protocols are not encrypted and could be intercepted at any intermediate point along the network communication path. Unencrypted email is similarly insecure.

## Weblogs

A *weblog*, or *blog* for short, is a mechanism for publishing periodic articles on a website. Depending on the author, the topic, and the nature of the blog, these articles could range from one paragraph to extensive articles comparable to those you might find in a newspaper or magazine.

A website might be organized entirely as a blog, or a blog might be just one aspect of a site that contains many other elements. The tools and online services available for creating and publishing blogs have made it easy for many novices to get a website up and running.

Weblogs have evolved significantly since they first came on the scene in the late 1990s. Although you can still find many blogs that discuss the inconsequential thoughts and activities of their authors, many blogs serve as outlets for serious thought leaders on a variety of topics. Some blogs are a great source of information regarding particular issues, and as such have a devoted following. In 2004, the *Merriam-Webster Dictionary* declared “blog” the word of the year.

Some bloggers refer to themselves as “citizen journalists,” promoting the idea that their blogs are as much a source of valid and valuable information as other media. One particular event is given credit for this change in status. In 2004, during the U.S. presidential campaign, CBS’s Dan Rather reported on documents that criticized the military service of George W. Bush, supposedly written by Bush’s former commander. Many bloggers challenged the authenticity of the documents based on numerous problems with the document’s typography. CBS and Rather defended the authenticity of the documents for more than two weeks before finally admitting the documents were probably forgeries. This event is one of the clearest examples of the Web providing a voice for the “average person” loud enough to challenge the traditional information brokers.

Because blogs are online publications, they can respond to events much more quickly than conventional print media. For that reason, many established journalists have developed their own blogs to supplement their work available through other, more traditional outlets.

### Save the trees



Environmentalists point out that to produce one week’s Sunday newspapers, 500,000 trees must be cut down. Recycling a single run of the Sunday *New York Times* would save 75,000 trees. Each ton of recycled paper can save 17 trees; those 17 trees can absorb a total of 250 pounds of carbon dioxide from the air each year. Burning that same ton of paper would create 1500 pounds of carbon dioxide. Also driving the current “go green” trends are the changing habits of consumers who increasingly get their daily news from online news and weblogs. Today, sales of papers and advertising have dropped so low that most newspapers are in financial trouble and will need to reinvent themselves quickly if they are to survive. Two bailout tactics are online video marketing and subscription charges for viewing online newspapers.

## Cookies

Cookies are another web-based technology that has advanced the abilities and usefulness of the Web to its users. A cookie is a small text file that a web server stores on your local computer's hard disk. A website may store a cookie on a user's machine to capture key information about previous interactions that occurred between that machine and that website.

The pieces of information stored in a cookie are name–value pairs, plus the name of the site that stores the information. For example:

```
UserID KDFH547FH398DFJ www.goto.com
```

As in this example, a website might generate a unique ID number for each visiting computer and store it on the local machine. More sophisticated cookies may store timing information about how long a site was visited and what information was viewed.

Websites use cookies in many different ways. Some websites use cookies to accurately determine how many unique visitors come to their site. Others store user preferences so that the website interaction is customized for that user. Cookies are also used to implement shopping carts that can be maintained from visit to visit.

One problem with using cookies is that people often share computers to use the Web. Because cookies are based on the machine that's making the connection (not the person), using cookies for personalizing the visit does not always work.

There are many misconceptions about cookies in general. A cookie is not a program, and it does not execute anything on your computer. It cannot collect personal information about you or your machine. Even so, cookies have not been embraced with open arms.

## Web Analytics

The word *analytics* refers to the discovery of patterns within data, which can be used to identify trends and help businesses make decisions. **Web analytics** is the collection and analysis of data regarding website usage. A person or organization running a website will often use a web analytics application to track the number and behavior of users coming to their site.

Google Analytics, for example, is a web analytics application that anyone can use to analyze the web traffic to a site. It lets you determine who visits your site—that is, where the visitors are geographically located and which site referred them (which site they were on when they clicked to

### Web analytics

The collection and analysis of data related to website usage





FIGURE 16.2 A Google Analytics dashboard

Google and the Google logo are registered trademarks of Google Inc., used with permission

enter yours). It tracks which pages users visit within your site, how long they stay on each page, and which page they were on when they decided to leave your site.

FIGURE 16.2 shows one of many versions of the Google Analytics dashboard, which presents information in graphical and numeric form. You can drill down into the analysis in various ways to gain further insight and customize the dashboard to present the data that is most important to you.

## 16.2 HTML and CSS

A webpage is created using a language called **Hypertext Markup Language (HTML)**. The term *hypertext* refers to the fact that the information is not organized linearly like a book. Instead, you can embed links to other information and jump from one page to another as needed. A more accurate term would be *hypermedia*, because HTML handles many types of information in addition to text, including images, audio, and video.

### Hypertext Markup Language (HTML)

The language used to create or build a web page



**Markup language** A language that uses tags to annotate the information in a document

**Tag** The syntactic element in a markup language that indicates how information should be displayed

**HTML5** The newest HTML standard, with a streamlined tag system and support for dynamic content

The term **markup language** refers to the fact that the primary elements of the language take the form of **tags** that you insert into a document to annotate the information stored there. It's as if you took a printed document and marked it up with extra notation to specify other details, as shown in **FIGURE 16.3**.

HTML documents are regular text and can be created in any general-purpose editor or word processor. Special software tools are also available to help designers create web pages, but these tools ultimately generate HTML documents. When a web page is requested, HTML documents are transported over the Web.

The current version of the HTML standard, **HTML5**, was released in 2012. The discussion in this section applies to HTML5. All of the major browsers support the HTML5 standard.

HTML works in conjunction with another technology: Cascading Style Sheets (CSS). In general, HTML tags indicate what the information is (such as a paragraph, an image, or a list), and the style information

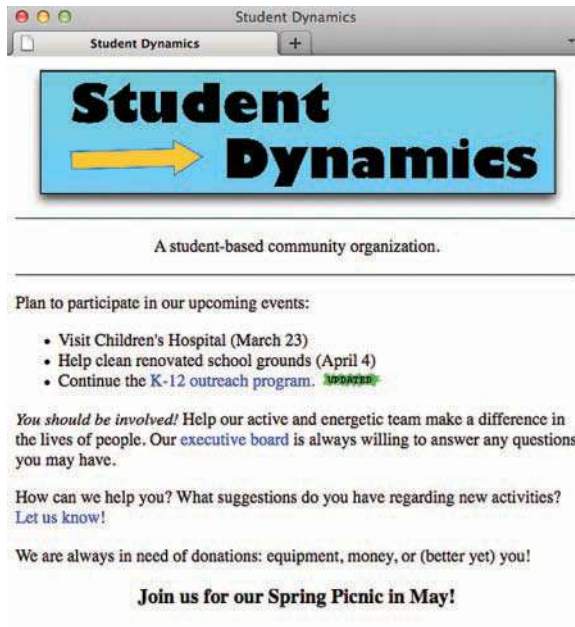


**FIGURE 16.3** A marked-up document

defined by CSS indicates how you want that information to be displayed (such as centered text, a border around an image, or a background color). Since it's of little use to discuss HTML without CSS, or vice versa, we'll explore both technologies at the same time.

Let's look at an example web page displayed by a browser and then examine the underlying HTML document that defines it. **FIGURE 16.4** shows a web page displayed in the Firefox browser. The page contains information about a fictional student organization called *Student Dynamics*.

This web page contains an image at the top showing the name of the group. Below the image, offset by a pair of horizontal lines, is a single phrase. Below that is some information about the organization, including a bulleted list of upcoming events followed by some short paragraphs. The small image at the end of one bulleted item indicates that this information has been recently updated. The text in blue represents a link that, when clicked, opens a new web page.



**FIGURE 16.4** The Student Dynamics web page as displayed in Firefox

Courtesy of John Lewis

FIGURE 16.5 shows the underlying HTML document for this web page. The tags embedded among the document contents are highlighted in blue.

```

<!DOCTYPE HTML>
<html>
<head>
 <title>Student Dynamics</title>
 <style type="text/css">
 img.banner {display:block; margin:auto;}
 a:link {color:#0000FF; text-decoration:none;}
 a:visited {color:#00FF00; text-decoration:none;}
 a:hover {color:#FF00FF; text-decoration:underline;}
 </style>
</head>
<body>

 <hr />
 <p style="text-align:center;">A student-based community organization.</p>
 <hr />
 <p>Plan to participate in our upcoming events:</p>

 Visit Children's Hospital (March 23)
 Help clean renovated school grounds (April 4)
 Continue the K-12 outreach program.

 <p>You should be involved! Help our active and energetic team make
 a difference in the lives of people. Our
 executive board is always willing to answer any questions you may
 have.</p>
 <p>How can we help you? What suggestions do you have regarding new
 activities? Let us know!</p>
 <p>We are always in need of donations: equipment, money, or (better yet)
 you!</p>
 <h3 style="text-align:center;">Join us for our Spring Picnic in May!</h3>
</body>
</html>

```

FIGURE 16.5 The HTML document defining the Student Dynamics web page

Tags are enclosed in angle brackets (< . . . >). Words such as `head`, `title`, and `body` are called *elements* and specify the type of tag. Elements often consist of a *start tag* such as `<body>` and a corresponding *end tag* with a `/` before the element name, such as `</body>`.

Every HTML file contains two main sections: the head of the document and the body of the document. The head contains information about the document itself, such as its title. The body of the document contains the information to be displayed.

The entire HTML document is enclosed between `<html>` and `</html>` tags. The head and body sections of the document are similarly indicated. The text between the `<title>` and `</title>` tags appears in the title bar of the web browser when the page is displayed.

The browser uses the tags, in conjunction with the styles specified by CSS, to determine how the page should be displayed. It ignores the way we format the HTML document using carriage returns, extra spaces, and blank lines. Indenting some lines of the document makes it easier for a human to read, but such formatting is irrelevant to the way it is finally displayed. A browser takes into account the width and height of the browser window. When you resize the browser window, the contents of the web page are reformatted to fit the new size.

A browser does its best to make sense of the way a document is marked up with tags and displays the page accordingly. If HTML tags conflict, or if they are not properly ordered or nested, the results may be surprising—and unattractive.

## Basic HTML Elements

Let's explore some of the core elements of HTML. This discussion will merely scratch the surface of HTML's capabilities, but even so it will give you the ability to create fairly versatile and useful web pages.

Paragraph tags (`<p>` . . . `</p>`) enclose text that should be treated as a separate paragraph. A browser usually begins each paragraph on a new line, with some space separating it from preceding and following paragraphs.

The `<hr />` tag inserts a horizontal rule (that is, a line) across the page. Horizontal rules are helpful in breaking a webpage into sections.

The horizontal rule element doesn't enclose content, so the start and end tag is combined into one, which is why the / is included at the end.

It is often useful to display a list of items. The `ul` element defines an unordered list, while the `li` element represents a single list item. In the Student Dynamics example, three list items are enclosed in the `<ul> . . . </ul>` tags. By default, the major browsers display an unordered list using bullets. If the ordered list element (`ol`) is used, the list items are numbered sequentially. Both unordered lists and ordered lists can be nested, creating a hierarchy of lists. Unordered nested lists use different bullet types for each level, and the numbering for each ordered list begins over again at each level.

Several elements are used to define headings in a document. HTML includes six predefined heading elements: `h1`, `h2`, `h3`, `h4`, `h5`, and `h6`. Text enclosed in `<h3> . . . </h3>` tags, for instance, is treated as a level 3 heading, which by default is displayed in a larger font than level 4 and a smaller font than level 2. Headings are also displayed in bold by default. Heading tags don't have to specify text that introduces a section; they can be used anywhere you want to change the look.

The `em` element specifies text that should be emphasized. By default, browsers display emphasized text in italics. The `strong` element is similar, and by default is displayed in bold type.

Note that the manner in which browsers display a particular element by default may vary slightly from browser to browser. Therefore, the same web page may look different depending on which browser you use to view it. But the default styling of any element can be modified using CSS styles.

## Tag Attributes

Many tags can contain **attributes** that indicate additional details about the information or describe how the enclosed information should be displayed. Attributes take the following form:

`attribute-name=value`

For example, the paragraph element just below the title image on the Student Dynamics page contains the attribute

`style="text-align:center"`

**Attribute** Part of a tag that provides additional information about the element

which is a CSS style specification indicating that the text of the paragraph should be centered horizontally on the page.

An image can be incorporated into a web page using the `img` element, which takes an attribute that identifies the image file to display. The attribute name is `src`, meaning the source of the image. There is no separate closing tag for the `img` element, so the `/` is used at the end. For example,

```

```

inserts the image stored in the file `myPicture.gif` into the HTML document.

In the Student Dynamics example, an image is used as a banner at the top of the page. In another location, a small image indicates which information on the website has been recently updated.

Finally, links are specified using the element `a`, which stands for *anchor*. An anchor tag contains an attribute called `href` that specifies the destination URL. For example,

```
Google It!
```

shows the text "Google It!" on the screen as a link. When the user clicks the link, the Google Home page is retrieved and displayed in the browser, replacing the current page.

By default, most browsers display a link in blue, underlined text. As with other elements, this default styling can be overridden with CSS style specifications. Let's explore CSS in more detail.

## More About CSS

We've seen how CSS styles can be specified as an attribute of an HTML element:

```
<p style="text-align:center">This text is centered!</p>
```

In this case, the `style` attribute indicates that the text of this paragraph should be centered instead of the default left alignment. But this style applies only to this single paragraph. What if we want to establish a style for all paragraphs on the page?

CSS styles can also be expressed in the head section of the HTML document. For example, we could put the following `style` tag (not an attribute this time, but a tag) between the `<head>` and `</head>` tags:

```
<style type="text/css">
 p {color:#00FF00;}
</style>
```

© Artur Debat/Getty Images; © Alan Dyer/Stocktrek Images/Getty Images

## Tim Berners-Lee

Tim Berners-Lee is the first holder of the 3COM (Computer Communication Compatibility) Chair at the Computer Science and Artificial Intelligence Laboratory (CSAIL) at Massachusetts Institute of Technology. He is the 3COM Founders Professor of Engineering in the School of Engineering with a joint appointment in the Department of Electrical Engineering and CSAIL at MIT. Berners-Lee is a researcher, evangelist, and visionary rather than an academician. He is Director of the World Wide Web Consortium, which coordinates web development worldwide. The Consortium, with teams at MIT, ERCIM in France, and Keio University in Japan, aims to help the Web achieve its full potential, ensuring its stability through rapid evolution and revolutionary transformations of its usage.

How did Tim Berners-Lee arrive at this very important position? He built his first computer while a student at Queen's College, Oxford, in the United Kingdom. After graduation, he worked for two years with Plessey Telecommunications Ltd., a major telecom equipment manufacturer in the United Kingdom; he then worked as an independent consultant for a year and a half, followed by three years at Image Computer Systems Ltd. His various projects during this time included real-time control firmware, graphics and communications software, and a generic macro language.

In 1984, Berners-Lee took up a fellowship at CERN, the European Organization for Nuclear Research in Geneva, Switzerland, where he worked on a heterogeneous remote procedure call system and a distributed real-time system for scientific data acquisition and system control. In 1989, he proposed a global hypertext

project to be known as the *World Wide Web*. It was designed to allow people to work together by combining their knowledge in a web of hypertext documents. Berners-Lee wrote the first World Wide Web server, "httpd," and the first client, "World Wide Web," a what-you-see-is-what-you-get hypertext browser/editor. The work began in October 1990, and the program "World Wide Web" was made available within CERN in December 1990 and on the Internet at large in the summer of 1991.

Between 1991 and 1993, Berners-Lee continued working on the design of the Web, coordinating feedback from users across the Internet.

His initial specifications of URLs, HTTP, and HTML were refined and discussed in larger circles as the web technology spread. Eventually, it became apparent that the physics lab in Geneva was not the appropriate place for the task of developing and monitoring the Web. In October 1994, the World Wide Web Consortium was founded by Berners-Lee at the MIT Laboratory for Computer Science.

In a *New York Times* article in 1995, Berners-Lee was asked about private corporations trying to dominate web standards for profit. He responded, "There's always the threat that a particular company would dominate the market and control the standards of the Web." But he feels strongly that this should not happen. "The essence of the Web is that it's a universe of information," he said. "And it wouldn't be universal if it was tied, in any way, to one company."

Michael Dertouzos, the director of the Computer Science Laboratory at MIT, has said



© Hank Morgan/Science Source

© Artur Debat/Getty Images; © Alan Dyer/Stocktrek Images/Getty Images

## Tim Berners-Lee (continued)

that Berners-Lee seems to embody the “libertarian idealism” of the Internet culture. “He has a real commitment to keeping the Web open as a public good, in economic terms,” Dertouzos said. “That’s his mission.” Berners-Lee concludes: “Reasonable competition speeds the pace of innovation. Companies will promote the proprietary aspects of their browsers and applications, and they should. But the navigation of the Web has to be open. If the day comes when you need six browsers on your machine, the World Wide Web will no longer be the World Wide Web.”

Berners-Lee was one of *Time* magazine’s 100 most important people of the twentieth century. In recognition of his work on the World Wide Web, Queen Elizabeth II made Berners-Lee a Knight Commander, Order of the British Empire (KBE).

In June 2007, he received the Order of Merit from Queen Elizabeth II, which entitles

him to use “OM” after his name and gives him membership in this dynastic order recognizing distinguished service. In September 2008, he was awarded the IEEE/RSE Wolfson James Clerk Maxwell Award for conceiving and further developing the World Wide Web, and in 2009 he was elected as a foreign associate of the National Academy of Sciences.

At the opening ceremony of the 2012 Summer Olympics in London, Berners-Lee was honored as the “Inventor of the World Wide Web.” He tweeted the words “This is for everyone,” which appeared in LCD lights attached to the chairs of the 80,000 people in the stadium. His philosophy: Everyone everywhere should have affordable access to the Internet. He is president of the Alliance for Affordable Internet, an organization launched in October 2013 that seeks to make the Internet more accessible and affordable worldwide.<sup>1</sup>

If we put this tag in the head of the document, it will apply to all paragraph tags in the document (unless it is overridden by a style attribute on a particular paragraph). In this case, the tag will cause all paragraph text to be colored green.

In the Student Dynamics example, the following style tag is used in the head section of the document:

```
<style type="text/css">
 img.banner {display:block; margin:auto;}
 a:link {color:#0000FF; text-decoration:none;}
 a:visited {color:#00FF00; text-decoration:none;}
 a:hover {color:#FF00FF; text-decoration:underline;}
</style>
```



The first style rule in this example applies to all `img` tags that have been designated with the class `banner` (using the `class` attribute). Element classes are used to specify a subset of elements. In the Student Dynamics example, the `banner` class is applied only to the image at the top of the page. By setting the margins to `auto`, we center the image horizontally on the page.

The other three style rules affect the various states of an anchor link. Recall that by default, a link is shown in blue underlined text. If we set `text-decoration` to `none`, the underline is removed. So, these rules establish that an unvisited link is shown in blue text with no underline, a visited link is shown in green with no underline, and when the mouse hovers over a link, the link text turns purple with an underline.

In addition to being able to specify styles at the element level and the document level, you can also put CSS style rules in a separate external file. That way, multiple pages, or even an entire website, can easily share a consistent set of style rules. And that's where the word *cascading* comes from in Cascading Style Sheets: Styles can be specified at multiple levels and overridden at lower levels as needed.

## More HTML5 Elements

The HTML5 standard streamlines many of the issues that were problematic in previous versions. It features many new tags to represent content, including:

- `<section>` - to define sections of pages
- `<header>` - to define the header of a page
- `<footer>` - to define the footer of a page
- `<nav>` - to define the navigation elements on a page
- `<article>` - to define an article or primary content of a page
- `<aside>` - to define secondary content that might appear in a sidebar
- `<figure>` - to define images that annotate an article

Another exciting aspect of HTML5 is its support of dynamic content—content that changes even if the user is not interacting with the page. Some dynamic techniques are discussed later in this chapter, though HTML5 may make some of them unnecessary over time.

One example of the support of dynamic content in HTML5 is the idea of a context menu for presenting drop-down menus as appropriate. There is also an additional attribute (`async`) that can be included in a tag to indicate content that should be loaded asynchronously, which helps increase page loading speed.

HTML5 also includes several new tags that support accepting input from a form, such as tags for time and dates, as well as fields for ranges, email addresses, and URLs.

Of course, this book can only provide a glimpse into the world of web page development using HTML and CSS. You are encouraged to use this as a starting point to explore this area of computing in more detail.

## 16.3 Interactive Web Pages

When HTML was first developed, it was amazing in its ability to format network-based text and images in interesting ways. However, that information was static—there was no way to interact with the information and pictures presented in a web page.

As users have clamored for a more dynamic Web, new technologies have been developed to accommodate these requests. These technologies take different approaches to solving the problem. Many of the new ideas are offshoots of the Java programming language, which is able to exploit the Web because of its platform independence. Let's look briefly at two of these technologies: *Java applets* and *Java Server Pages*.

### Java Applets

A **Java applet** is a program that is designed to be embedded into an HTML document and transferred over the Web to someone who wants to run the program. An applet is actually executed in the browser used to view the web page.

An applet is embedded into an HTML document using the `APPLET` tag. For example:

```
<applet code="MyApplet.class" width=250 height=160>
</applet>
```

**Java applet** A Java program designed to be embedded into an HTML document, transferred over the Web, and executed in a browser

When a web user references the page containing this tag, the applet program `MyApplet.class` is sent, along with any text, images, and other data that the page contains. The browser knows how to handle each type of data—it formats text appropriately and displays images as needed. In the case of an applet, the browser has a built-in interpreter that executes the applet, allowing the user to interact with it. Thousands of Java applets are available on the Web, and most browsers are set up to execute them.

Consider the difficulties inherent in this situation. A program is written on one computer, but then may be transferred to any other computer on the Web to be executed. How can we execute a program that was written for one type of computer on possibly many other types of computers? The key, as briefly explained in Chapter 9, is that Java programs are compiled into Bytecode, a low-level representation of a program that is not the machine code for any particular type of CPU. This Bytecode can be executed by any valid Bytecode interpreter, no matter which type of machine it is running on.

The applet model puts the burden on the client's machine. That is, a web user brings the program to his or her computer and executes it there. It may be frightening to think that, while you are casually surfing the Web, suddenly someone's program may begin executing on your computer. That would be a problem, except that Java applets are restricted as to what they can do. The Java language has a carefully constructed security model. An applet, for instance, cannot access any local files or change any system settings.

Depending on the nature of the applet, the client's computer may or may not be up to the job of executing the applet. For this reason, and because applets are transferred over a network, they tend to be relatively small. Although appropriate for some situations, applets do not resolve all of the interactive needs of web users.

## Java Server Pages

A Java Server Page (JSP) is a web page that has **JSP scriptlets** embedded in it. A scriptlet is a small piece of executable code intertwined among regular HTML content. While not exactly the same as Java, JSP code resembles the general Java programming language.

A JSP scriptlet is encased in special tags beginning with `<%` and ending with `%>`. Special objects have been predefined to facilitate some processing. For example, the object called `out` can be used to produce output, which is

**JSP scriptlet** A portion of code embedded in an HTML document designed to dynamically contribute to the content of the web page

integrated into the web page wherever the scriptlet occurs. The following scriptlet produces the phrase “hello there” between the opening and closing tag of an h3 header:

```
<h3>
<%
out.println (“hello there”);
%>
</h3>
```

In this particular case, the result is equivalent to

```
<h3>hello there</h3>
```

But imagine JSP scriptlets as having the expressive power of a full programming language (which they do). We can make use of almost all aspects of a regular Java program, such as variables, conditionals, loops, and objects. With that kind of processing power, a JSP page can make significant decisions resulting in truly dynamic results.

JSPs are executed on the server side, where the web page resides. They help dynamically define the content of a web page before it is shipped to the user. By the time it arrives at your computer, all active processing has taken place, producing a static (though dynamically created) web page.

JSPs are particularly good for coordinating the interaction between a web page and an underlying database. The details of this type of processing are beyond the scope of this book, but you’ve probably encountered this type of processing while surfing the Web. Electronic storefronts (sites that exist primarily to sell products), in particular, make extensive use of this type of processing. The data about available products is not stored in static HTML pages. Instead, this data is stored in a database. When you make a request for information about a particular product, a JSP may actually respond to you. The scriptlets in the page interact with the database and extract the needed information. Scriptlets and regular HTML format the data appropriately and then ship the page to your computer for viewing.

## 16.4 XML

HTML is fixed; that is, HTML has a predefined set of tags and each tag has its own semantics (meaning). HTML specifies how the information in a web page should be formatted, but it doesn’t really indicate what the

### The importance of standards: Wi-Fi

Wi-Fi is the wireless networking technology that is now common in laptop computers. In an effort to improve the wireless transfer of large files (such as movies), computer manufacturers are using components that use a faster version of Wi-Fi called 802.11ac. Version 802.11ac increases the top speed of a Wi-Fi network to 1.3 gigabits per second (Gbps), a substantial increase from the current 802.11n standard.

**Extensible Markup Language (XML)** A language that allows the user to describe the content of a document

**Metalanguage** A language that is used to define other languages

**Document Type Definition (DTD)** A specification of the organization of an XML document

information represents. For example, HTML may indicate that a piece of text should be formatted as a heading, but it doesn't specify what that heading describes. In fact, nothing about HTML tags describes the true content of a document. The **Extensible Markup Language (XML)** allows the creator of a document to describe its contents by defining his or her own set of tags.

XML is a metalanguage. *Metalanguage* is the word *language* plus the prefix *meta-*, which means “beyond” or “more comprehensive.” A **metalanguage** goes beyond a normal language by allowing us to speak precisely about that language. It is a language for talking about, or defining, other languages. It is like an English grammar book describing the rules of English.

A metalanguage called the *Standard Generalized Markup Language* (SGML) was used by Tim Berners-Lee to define HTML. XML is a simplified version of SGML and is used to define other markup languages. XML has taken the Web in a new direction. It does not replace HTML—it enriches it.

Like HTML, an XML document is made up of tagged data. But when you write an XML document, you are not restricted to a predefined set of tags, because there are none. You can create any set of tags necessary to describe the data in your document. The focus is not on how the data should be formatted, but rather on what the data is.

For example, the XML document in **FIGURE 16.6** describes a set of books. The tags in the document annotate data that represents a book's title, author(s), number of pages, publisher, ISBN number, and price.

The first line of the document indicates the version of XML that is used. The second line indicates the file that contains the **Document Type Definition (DTD)** for the document. The DTD is a specification of the organization of the document. The rest of the document contains the data about two particular books.

The structure of a particular XML document is described by its corresponding DTD document. The contents of a DTD document not only define the tags, but also show how they can be nested. **FIGURE 16.7** shows the DTD document that corresponds to the XML books example.

The **ELEMENT** tags in the DTD document describe the tags that make up the corresponding XML document. The first line of this DTD file indicates that the **books** tag is made up of zero or more **book** tags. The asterisk (\*) beside the word **book** in parentheses stands for zero or more. The next line specifies that the **book** tag is made up of several other tags in a particular order: **title**, **authors**, **publisher**, **pages**, **isbn**, and **price**. The next line

```

<?xml version="1.0" ?>
<!DOCTYPE books SYSTEM "books.dtd">
<books>
<book>
<title>The Hobbit</title>
<authors>
 <author>J. R. R. Tolkien</author>
</authors>
<publisher>Ballantine</publisher>
<pages>287</pages>
<isbn>0-345-27257-9</isbn>
<price currency="USD">7.95</price>
</book>
<book>
<title>A Beginner's Guide to Bass Fishing</title>
<authors>
 <author>J. T. Angler</author>
 <author>Ross G. Clearwater</author>
</authors>
<publisher>Quantas Publishing</publisher>
<pages>750</pages>
<isbn>0-781-40211-7</isbn>
<price currency="USD">24.00</price>
</book>
</books>

```

**FIGURE 16.6** An XML document containing data about books

indicates that the `authors` tag is made up of one or more `author` tags. The plus sign (+) beside the word `author` indicates one or more authors are permitted. The other tags are specified to contain PCDATA (Parsed Character Data), which indicates that the tags are not further broken down into other tags.

```

<!ELEMENT books (book*)>
<!ELEMENT book (title, authors, publisher, pages, isbn, price)>
<!ELEMENT authors (author+)>
<!ELEMENT title (#PCDATA)>
<!ELEMENT author (#PCDATA)>
<!ELEMENT publisher (#PCDATA)>
<!ELEMENT pages (#PCDATA)>
<!ELEMENT isbn (#PCDATA)>
<!ELEMENT price (#PCDATA)>
<!ATTLIST price currency CDATA #REQUIRED>

```

**FIGURE 16.7** The DTD document corresponding to the XML books document

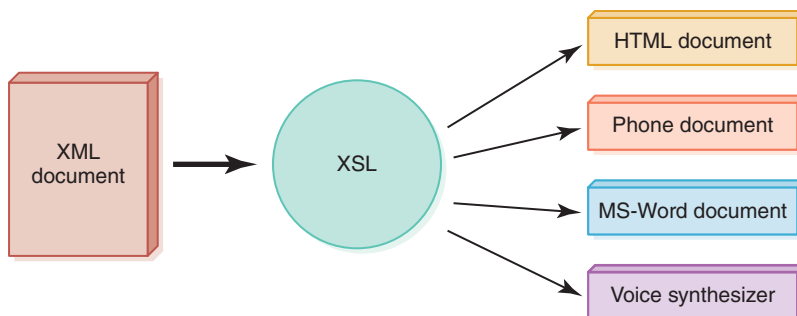
**Extensible Stylesheet Language (XSL)** A language for defining transformations from XML documents to other output formats

The only tag in this set that has an attribute is the `price` tag. The last line of the DTD document indicates that the `price` tag has an attribute called `currency` and that it is required.

XML provides a standard format for organizing data without tying it to any particular type of output. A related technology called **Extensible Stylesheet Language (XSL)** can be used to transform an XML document into another format suitable for a particular user. For example, an XSL document can be defined that specifies the transformation of an XML document into an HTML document so that it can be viewed on the Web. Another XSL document might be defined to transform the same XML document into a Microsoft Word document, into a format suitable for a mobile phone, or even into a format that can be used by a voice synthesizer. This process is depicted in [FIGURE 16.8](#). We do not explore the details of XSL transformations in this book.

Another convenient characteristic of languages specified using XML is that documents in the language can be generated automatically with relative ease. A software system, usually with an underlying database, can be used to generate huge amounts of specific data formatted in a way that is easily conveyed and analyzed online. Once generated, the data can be transformed and viewed in whatever manner best serves individual users.

Several organizations have already developed XML languages for their particular topic areas. For example, chemists and chemical engineers have defined the Chemistry Markup Language (CML) to standardize the format of molecular data. CML includes a huge number of tags covering specific aspects of chemistry. It provides a common format by which chemistry professionals can share and analyze data.



**FIGURE 16.8** An XML document can be transformed into many output formats

Keep in mind that XML is a *markup specification language*, whereas XML files are *data*. The files just sit there until you run a program that displays them (like a browser), does some work with them (like a converter that writes the data in another format or a database that reads the data), or modifies them (like an editor). XML and its related technologies provide a powerful mechanism for information management and for communicating that information over the Web in a versatile and efficient manner. As these technologies evolve, new opportunities to capitalize on them will surely emerge.

## 16.5 Social Network Evolution

For many people, life on the Web involves heavy use of *social networks* to stay in touch with friends, family members, colleagues, and people they don't know personally but want to "follow." A **social network** is an online service or website designed to allow people with shared interests to interact. The functionality provided by a social network facilitates communication in order to share ideas, events, and interests.

Today, some of the most popular social networks include Facebook, Twitter, LinkedIn, Pinterest, Tumblr, and Instagram, though there are many others. Facebook currently has more than 1.2 billion members. Twitter, the second most popular site, has 255 million members.

Social networking online has a rich history. The first online community was formed in 1985 and began as a dial-up bulletin board system. Classmates.com began in 1995 to connect former schoolmates. In 1997, SixDegrees.com was formed as a website that focused on indirect relationships. Users were allowed to list family, friends, and acquaintances and post bulletin-board items and send messages to people in their first, second, and third degrees. This website was sold in 2000 for \$125 million. A bevy of networking websites appeared in the early 2000s, with MySpace emerging as the biggest one by 2005.

Facebook was created by Mark Zuckerberg at Harvard University in 2004. It quickly gained traction through Zuckerberg's clever strategies for getting college students committed to using it. LinkedIn was created in 2002 to facilitate networking among professionals with similar interests. Twitter launched in 2006, focusing on short posts called *tweets*.

Online social networks often allow users to be classified into two general categories: internal, in which the participants are within a closed or private community such as a company, association, or organization; and external, in which there is no restriction on the participants. In general, both categories allow users to describe themselves, to set privacy settings,

**Social network** An online service that allows people with shared interests to communicate and interact

### Privacy of photo sharing/tagging

Most social networking sites allow members to upload their own photos. Once uploaded, these photos can be labeled with the date and the location and "tagged" with the name of everyone in the photo—sometimes even if that person is not a member of the social networking site. Facebook later changed its policy. Now you can adjust your settings so that if someone tags you in a photo, you must approve of that tag before it takes effect.



**Think before you tweet**

Before boarding a flight to Africa, a public relations executive tweeted, “Going to Africa. Hope I don’t get AIDS. Just kidding. I’m white!” Her tweet was widely considered to be racist and went viral. She was fired before her plane landed.<sup>2</sup>

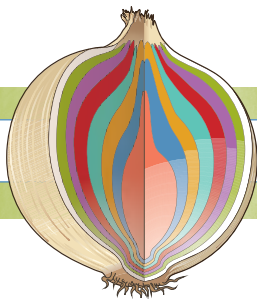
to block unwanted members, to have personal pages for pictures and/or blogging, and to form or be a member of a community within the network.

The concept of a social network has been around much longer than the online version we know on the Web, and is the backbone of serious sociological research. In broader terms, a social network is a model of how objects—individuals or organizations—interact. In this type of network, objects are represented as nodes that are tied together by some sort of interdependency such as friendship, kinship, religion, or socioeconomic background. Social network analysis views social relationships in terms of network theory about nodes and the ties between the nodes. Within a specific social network, nodes may be related by multiple ties. A network can be thought of as a map of all relevant interconnections among the objects being modeled.

Research into social networks began in the 1800s. Networks have been used to model such diverse areas as the spread of new ideas and practices, the spread of diseases, and the formation of emotional clusters. One study showed that happiness tends to be correlated within social networks. When a person is happy, nearby friends have a 25% higher chance of being happy. Clusters of unhappy people were also found.

Have you ever heard the expression “six degrees of separation”?<sup>3</sup> The *small world phenomenon* is the hypothesis that the chain of social acquaintances necessary to connect any two arbitrary people is generally short. Stanley Milgram’s social network study in 1967 showed the chain to be about six steps, leading to the famous phrase. Although his methods were later questioned, a recent study found that five to seven steps were sufficient to connect any two people through email.

The impact of social networks online cannot be overstated, and follow from a long history of similar interactions before we had the technological support we do today.



© Artur Debat/Getty Images; © Alan Dyer/Stocktrek Images/Getty Images

## SUMMARY

Although the terms *Internet* and *Web* are often used interchangeably, they are not the same. The World Wide Web is an infrastructure of information distributed among thousands of computers across the world and the software by which that information is accessed. The Web relies on underlying networks, especially the Internet, as the vehicle to exchange the information among users.

A web page contains information as well as references to other resources, such as images. A collection of web pages managed by a single person or company is called a *website*. Links are established among various web pages across the globe, giving credence to the name *World Wide Web*.

Visiting a website is really the act of requesting that a web page stored on a remote web server be brought to the local computer for viewing. A Uniform Resource Locator (URL) is used to specify the web document the user wishes to view.

Some websites, such as that run by Google, serve as search engines, allowing the user to enter a word or phrase on which to base a search for information. The search engine responds with a list of candidate websites that the user hopes will match his or her needs. Some search engines are based solely on the keywords entered in the search; others try to interpret the concept underlying the search.

Instant messaging (IM) applications have given the Web another level of interaction, allowing users to conduct ongoing conversations online. IM programs have evolved to include graphics and even video.

Weblogs, or blogs, are web-based publications that feature regularly updated articles. The more serious blogs serve as significant resources on particular topics. Others have given rise to “citizen journalists,” whose work supplements that of the mainstream media.

Cookies are small text files that a website deposits on your hard drive, so that when you return to the site, information about you and your prior visit can be incorporated into your current visit. Cookies are often used to track the activities of users, and they are generally considered helpful for both the user and the sites using them. A cookie is not a program, so it cannot execute code on your computer.

Hypertext Markup Language (HTML) is the primary method of defining web pages. An HTML document consists of information that is annotated by tags that specify how a particular element should be treated and formatted. A web browser displays an HTML page without regard to extra spacing, blank lines, or indentation. The tags alone guide the browser, and a given web page may look slightly different when viewed in different browsers.

HTML tags include those that specify the overall document structure as well as tags that perform basic formatting, such as for headings, paragraphs, and centered text. Font styles, such as bold and italics, are specified using tags as well. Unordered and ordered lists have their own sets of tags.

Some HTML tags include attributes that specify additional information. The source attribute of an image tag specifies the file in which the image is stored, for instance. Anchor tags define links and use an attribute to specify the location of the target web page.

There are additional opportunities to interact with and dynamically create the content of web pages. Two technologies that support web-based interaction are Java applets and Java Server Pages (JSPs). Java applets are Java programs designed to be embedded in HTML pages and executed in a web browser. Their cross-platform nature is possible because applets are compiled into Java Bytecode, which is architecture neutral.

Java Server Pages embed scriptlets into HTML code that is executed by the web server to help dynamically define the content of a web page. Scriptlets have all the expressive power of a full language. JSPs are particularly good at coordinating the interaction between a web page and its underlying database.

Extensible Markup Language (XML) is a metalanguage, which means it is used to define other languages. Unlike HTML, whose tags focus on the format of displayed data, XML tags specify the nature of the data. The user is not constrained to use particular tags; he or she can define any tags that make sense for the data being described.

The format and relationships among XML tags are defined in a Document Type Definition (DTD) document. A set of Extensible Stylesheet Language (XSL) transformations define the way the content of an XML document is turned into another format suitable for the current needs of the user.

Social networks are an important part of the way many people interact on the Web. Services like Facebook and LinkedIn facilitate communication among people with similar interests, and they largely eliminate the issue of distance. In general, social networks have a long history, providing a sociological mechanism for studying many kinds of interactions, including the spread of diseases as well as ideas.



## ETHICAL ISSUES

### **Gambling and the Internet<sup>4,5</sup>**

Most people think of gambling as sitting in front of a blackjack table or a slot machine in a Las Vegas casino, but more and more people are turning to the Internet to gamble. Online gambling exploded onto the Internet in August 1995, when Internet Casinos, Inc., became the first online casino to accept real wagers. Since then, online gambling has grown into a multibillion-dollar-per-year business, with most of the businesses being run offshore. In 2008, Internet gambling sites earned revenues of \$5.9 billion from players in the United States alone and \$21 billion worldwide.

Internet sites offer online poker, roulette, blackjack, pachinko, baccarat, sports betting, bingo, and lotteries. With the advent of smartphones, mobile gambling has become popular. As of March 2011, more than a dozen mobile casinos were operating.

With the growth of the online gambling industry, the issue of fraud has become a serious problem. The potential for fraud over an Internet gambling site is quite high. Gamblers provide credit card information and Social Security numbers to start an account, trusting that the games will be run fairly. In the United States, all traditional casinos are regulated by the American Gaming Association to be sure that the

games are run honestly. With the design of the Internet sites, however, it is impossible for the user to know whether the games are operated fairly; instead, gamblers must rely solely on the honesty of those operating the site—about whom they know nothing.

Another problem with Internet gambling is that it reduces state tax revenues. State governments earn profits from state-run gambling organizations, but they lose revenue from gamblers who use Internet gambling sites because these are run offshore and are not subject to state taxation. Some states have been relying on state gambling laws to curb online gambling: Illinois, Indiana, Louisiana, Massachusetts, Nevada, Oregon, South Dakota, and Utah have all passed laws banning Internet gambling. State regulation is for the most part ineffective, however, because the Internet goes beyond state and national restrictions.

The U.S. Congress has worked over the years to pass legislation that would ban all Internet gambling, but because such a ban would be so broad in scope, lawmakers have been largely unsuccessful. In 2011, the U.S. Justice Department changed its position on Internet gambling by stating that the Interstate Wire Act of 1961 applies only to sports betting. The position that this bill applies to



## ETHICAL ISSUES

### Gambling and the Internet (CONTINUED)

Internet gambling in general was the basis of the argument that online poker violates U.S. law. Since this reinterpretation, Nevada, Delaware, and New Jersey have legalized

forms of online gambling. In March 2014, a high-profile, bipartisan group of senators introduced legislation to ban most forms of online gambling.

© Artur Debat/Getty Images; © Alan Dyer/Stocktrek Images/Getty Images

## KEY TERMS

Attribute

Document Type Definition (DTD)

Extensible Markup Language (XML)

Extensible Stylesheet Language (XSL)

HTML5

Hypertext Markup Language (HTML)

Java applet

JSP scriptlet

Link

Markup language

Metalinguage

Social network

Tag

Uniform Resource Locator (URL)

Web browser

Web page

Web server

Website

World Wide Web (the Web)

© Artur Debat/Getty Images; © Alan Dyer/Stocktrek Images/Getty Images

## EXERCISES

For Exercises 1–14, mark the answers true or false as follows:

- A. True
  - B. False
1. The Internet and the Web are essentially two names for the same thing.
  2. The computer that is set up to respond to web requests is a web browser.
  3. When we visit a website, we actually bring the site to us.
  4. Most search engines use a context-based approach for finding candidate pages.

**EXERCISES (CONTINUED)**

5. A weblog is the same thing as a blog.
6. A weblog can serve as an online publication for “citizen journalists.”
7. A cookie is a program that is executed on your computer.
8. All elements associated with a particular web page are brought over when a request for that web page is made.
9. HTML and CSS are often used together.
10. CSS is used to specify the content of a web page.
11. Networks have been used to connect computers since the 1950s.
12. Network communication was not possible until the advent of the Web.
13. The Web was developed in the mid-1990s.
14. You must have a web browser to access the Web.
21. \_\_\_\_\_ is a metalanguage.
22. The structure of an \_\_\_\_\_ document is described by its corresponding Document Type Definition (DTD).
23. The syntactic element in a markup language that indicates how information should be displayed.
24. Part of a \_\_\_\_\_ is the hostname of the computer on which the information is stored.

Exercises 25–76 are problems or short-answer questions.

For Exercises 15–24, match the word or acronym with the definition or blank.

- A. JSP scriptlet
- B. URL
- C. HTML
- D. Tag
- E. Java applet
- F. XML
15. A program designed to be embedded into an HTML document.
16. Uniquely identifies every web page.
17. \_\_\_\_\_ runs on the web server.
18. \_\_\_\_\_ runs on the web browser.
19. Tags in \_\_\_\_\_ are fixed.
20. Tags in \_\_\_\_\_ are not predefined.
25. What is the Internet?
26. What is the Web?
27. What is a web page?
28. What is a website?
29. What is a link?
30. Why is a spiderweb a good analogy for the World Wide Web?
31. What is the relationship between a web page and a website?
32. What is the difference between the Internet and the Web?
33. Describe how a web page is retrieved and viewed by a web user.
34. What is a Uniform Resource Locator?
35. What is a markup language? Where does the name come from?
36. Compare and contrast hypertext and hypermedia.
37. Describe the syntax of an HTML tag.
38. What is a horizontal rule? What are these rules useful for?
39. What is a tag attribute? Give an example.

**EXERCISES (CONTINUED)**

40. Write the HTML statement that inputs the image on file `mine.gif` into the web page.
41. Write the HTML statement that sets up a link to `http://www.cs.utexas.edu/users/ndale/` and shows the text “Dale Home Page” on the screen.
42. What happens when a user clicks on “Dale Home Page” as set up in Exercise 40?
43. Which CSS style rule would you use to horizontally center a line of text?
44. What are the three ways in which CSS style rules can be expressed for a web page?
45. Design and implement an HTML document for an organization at your school.
46. Design and implement an HTML document describing one or more of your personal hobbies.
47. What is a Java applet?
48. How do you embed a Java applet in an HTML document?
49. Where does a Java applet get executed?
50. What kinds of restrictions are put on Java applets? Why?
51. What is a Java Server Page?
52. What is a scriptlet?
53. How do you embed a scriptlet in an HTML document?
54. How does JSP processing differ from applet processing?
55. What is a metalanguage?
56. What is XML?
57. How are HTML and XML alike, and how are they different?
58. How does an XML document relate to a Document Type Definition?
59.
  - a. In a DTD, how do you indicate that an element is to be repeated zero or more times?
  - b. In a DTD, how do you indicate that an element is to be repeated one or more times?
  - c. In a DTD, how do you indicate that an element cannot be broken down into other tags?
60. What is XSL?
61. What is the relationship between XML and XSL?
62. How does an XML document get viewed?
63. Define an XML language (the DTD) for your school courses and produce a sample XML document.
64. Define an XML language (the DTD) for political offices and produce a sample XML document.
65. Define an XML language (the DTD) for zoo animals and produce a sample XML document.
66. This chapter is full of acronyms. Define each of the following ones:
  - a. HTML
  - b. XML
  - c. DTD
  - d. XSL
  - e. SGML
  - f. URL
  - g. ISP

**EXERCISES (CONTINUED)**

67. Create an HTML document for a web page that has each of the following features:
  - a. Centered title
  - b. Unordered list
  - c. Ordered list
  - d. Link to another web page
  - e. A picture
68. Distinguish between an HTML tag and an attribute.
69. Why might the same web page look different in different browsers?
70. What are the two sections of every HTML document?
71. What are the contents of the two parts of an HTML document?
72. What does the “A” stand for in the tag that specifies a URL for a page?
73. Create an HTML document for a web page that has each of the following features:
  - a. A right-justified title in large type font
  - b. An applet class named `Exercise.class`
  - c. Two different links
  - d. Two different pictures
74. Which social networking site currently has the most users?
75. What is the *small world phenomenon*?
76. What did the term “social network” mean before the online version we know today became popular?

**THOUGHT QUESTIONS**

1. How has the Web affected you personally?
2. Did you have a website before you started this class? How sophisticated was it? Did you use HTML or some other web design language? If you used some other language, go to your website and view your pages as source pages. Look at the HTML tags that actually format your website. Are there any there that we have not discussed in this chapter? If so, look them up to see what they mean. (Where? On the Web, of course.)
3. Have you ever taken a web-based course? Did you enjoy the experience? Did you feel that you learned less or more than you would have in a regular classroom-based course?
4. Describe your vision of the future as it relates to the Web.
5. What is the current state of online gambling?



## Laying the Groundwork

- 1 The Big Picture

## The Information Layer

- 2 Binary Values and Number Systems
- 3 Data Representation

## The Hardware Layer

- 4 Gates and Circuits
- 5 Computing Components

## The Programming Layer

- 6 Low-Level Programming Languages and Pseudocode
- 7 Problem Solving and Algorithms
- 8 Abstract Data Types and Subprograms
- 9 Object-Oriented Design and High-Level Programming Languages

## The Operating Systems Layer

- 10 Operating Systems
- 11 File Systems and Directories

## The Applications Layer

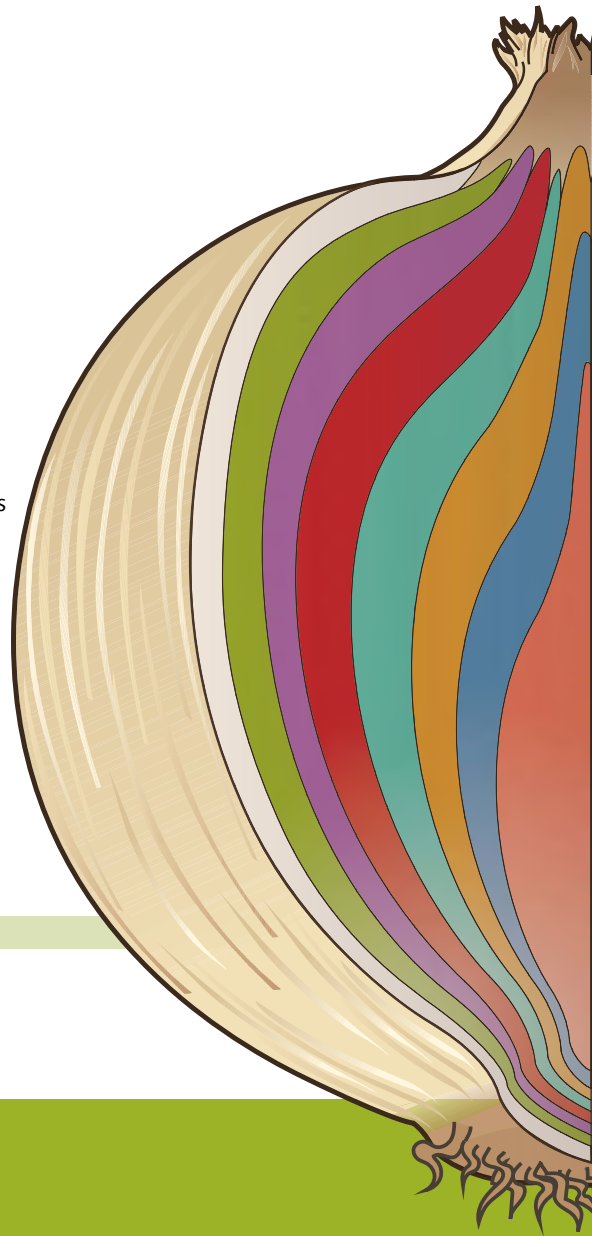
- 12 Information Systems
- 13 Artificial Intelligence
- 14 Simulation, Graphics, Gaming, and Other Applications

## The Communications Layer

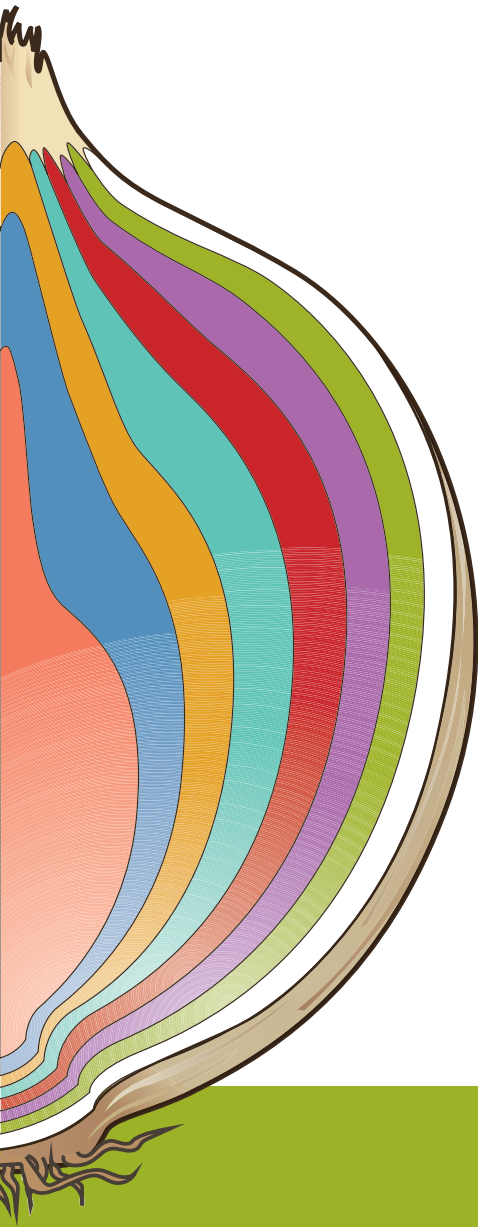
- 15 Networks
- 16 The World Wide Web
- 17 Computer Security

## In Conclusion

- 18 Limitations of Computing



# THE COMMUNICATIONS LAYER



## 17

# COMPUTER SECURITY

Various issues related to computer security have been discussed in chapters throughout this book as appropriate, often dealing with level-specific topics such as memory management or network access. In this chapter, we explore security as a general concept and zero in on the most prevalent issues faced by typical users in today's online world. The topics discussed in this chapter include techniques for preventing unauthorized access to information, the types of malicious code used to circumvent security measures, and the security issues related to social media.

## GOALS

After studying this chapter, you should be able to:

- explain the three cornerstones of information security.
- describe the three types of authentication credentials.
- create secure passwords and assess the security levels of others.
- define the categories of malware.
- list the types of security attacks.
- define *cryptography*.
- encode and decode messages using various ciphers.
- discuss the challenges of keeping online data secure.
- discuss the security issues related to social media and mobile devices.

## 17.1 Security at All Levels

The organizational structure of this book follows our big-picture view of a computing system, using the analogy of an onion with multiple layers. Issues related to computer security must be dealt with at all levels in various ways.

Some aspects of security have been discussed in earlier chapters. For example, in Chapter 10 we established that one of the many responsibilities of an operating system is to ensure that one program does not access another program's area in memory. Chapter 11 discussed protection rights established in a file system, giving a user particular authority to read, modify, and/or delete individual files. Chapter 15 explored firewalls, which are used to protect the resources of a network by filtering the traffic allowed.

Those examples focus on issues that relate to particular aspects of a computing system, specific to a particular layer. This chapter focuses on security issues that span some of the high levels of a computing system. These issues largely deal with application software that runs on a computer, but are intertwined with issues related to programming, web access, and mobile computing. In this chapter, we address a variety of security issues that weren't covered in previous chapters.

In many instances this chapter examines security issues that *you* must deal with or be responsible for. Although you don't have control over some computer security issues, such as the access policy of your network, you *are* responsible for many aspects of your day-to-day life that relate to how your information is managed and accessed.

### Information Security

Many of the high-level issues discussed in this chapter involve **information security**, the set of techniques and policies enforced by an organization or individual to ensure proper access to protected data. Information security makes certain that data cannot be read or modified by anyone without the proper authorization, and that the data will be available when needed to those who do.

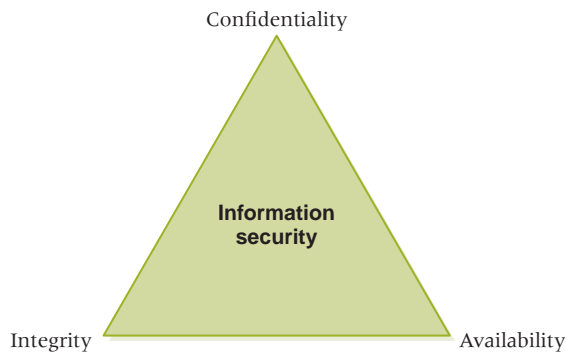
Information security is technically distinct from *cyber security*, which is the ability to protect or defend the use of cyberspace (resources accessible on the Internet) from attack. See [FIGURE 17.1](#). However, because most

#### Information security

The techniques and policies used to ensure proper access to data



**FIGURE 17.1** The overlap of cyber security and information security



**FIGURE 17.2** The CIA triad of information security

information is stored electronically on devices that are accessible via the Internet, the two concepts overlap significantly and the terms are sometimes used interchangeably.

Information security can be described as the synthesis of confidentiality, integrity, and availability—the so-called *CIA triad*, depicted in [FIGURE 17.2](#). Although these aspects of information security overlap and interact, they define three specific ways to look at the problem. Any good solution to the information security problem must adequately address each of these issues.

**Confidentiality** is ensuring that key data remains protected from unauthorized access. For example, you don't want just anyone to be able to learn how much money you have in your savings account.

**Integrity** is ensuring that data can be modified only by appropriate mechanisms. It defines the level of trust you can have in the information. You don't want a hacker to be able to modify your bank balance, of course, but you also don't want a teller (who has authorized access) to modify your balance in inappropriate ways and without your approval. Furthermore, you wouldn't want your balance changed by a power surge or compromised during an electronic transmission of the data.

**Availability** is the degree to which authorized users can access appropriate information for legitimate purposes when needed. Even if data is protected, it isn't useful if you can't get to it. A hardware problem such as a disk crash can cause an availability problem if precautions aren't taken to back up data and maintain redundant access mechanisms. Also, a hacker could launch an attack that "floods" a network with useless transmissions, and thereby keep legitimate users from connecting to remote systems.

### Confidentiality

Ensuring that data is protected from unauthorized access

**Integrity** Ensuring that data can be modified only by appropriate mechanisms

**Availability** The degree to which authorized users can access information for legitimate purposes

### New life for the old barcode

The barcode is more than 60 years old, but new uses are still being invented for it. Barcodes now appear in places like advertisements and even buildings. Cell phone users photograph the codes and use them to connect to new services using the mobile Internet. One service, Scanbuy Shopper, scans a product's Universal Product Code (UPC) and downloads shopping.com prices and reviews of the product. A barcode on a grocery item can direct a cell phone to a website with recipes and health tips; one on a business card can direct it to a company's website; and a barcode on a building (like the Chrysler Building) will send visitors to that building's Wikipedia entry.

**Risk analysis**

Determining the nature and likelihood of the risks to key data

**User authentication**

The process of verifying the credentials of a particular user of a computer or software system

**Authentication credentials**

Information users provide to identify themselves

**Smart card** A card with an embedded memory chip used to identify users and control access

**Biometrics** Using physiological characteristics, such as fingerprints, to identify users and control access

From a business point of view, planning for information security requires **risk analysis**, which is the process of determining which data needs protecting, identifying the risks to that data, and calculating the likelihood that a risk may become reality. Once a risk analysis is complete, plans can be implemented to manage the risks accordingly. A risk is the pairing of a threat to a vulnerability. We want to minimize our vulnerability to threats that put us at the most risk. These threats can be either malicious, such as those posed by a hacker, or accidental, such as a system crash.

Another principle embraced by information security experts is the concept of separating the available data management privileges so that no single individual has the authority to have a significant impact on the system. This principle is often implemented by having redundant checks and/or approvals needed for key activities. For instance, large financial transactions often require a separate authorization process. Administrators should assign to an individual only those privileges needed to carry out his or her job functions.

Central to the confidentiality and integrity of your data is making sure unauthorized users cannot gain access to your account. That's where we'll continue our discussion of security issues.

## 17.2 Preventing Unauthorized Access

One of the most obvious security issues from the user's perspective is keeping other people from accessing your accounts and information. When you log into a website, for example, providing a username and password, you are performing **user authentication**. That is, you are convincing the software system that you are who you say you are.

In the website example, the username and password make up the **authentication credentials**, the information provided by the user to identify themselves. There are three general types of authentication credentials. The first, and most common, is based on something that the user *knows*, such as a username and password, a personal identification number (PIN), or a combination of these items.

The second type is based on something that the user *has*, such as an identification card with a magnetic strip or a **smart card** that contains an embedded memory chip. This approach is more complex to administer, and often requires special hardware, but is generally considered more secure than the first.

The third type of authentication credentials is based on **biometrics**, which are related to what a person *is* physiologically. Examples of biometrics include the analysis of fingerprints, retina pattern, or voice pattern. This approach is

the most expensive to implement, although the process of fingerprint analysis has dropped significantly in cost in recent years. Biometric analysis must deal with the problems of false rejection (rejecting an authorized individual) and false acceptance (accepting an unauthorized individual).

No matter which mechanism is used, if the process of user authentication is compromised, and someone who is *not* you gets access to your account as if they *are* you, then they might shut you out of your own account by changing the password. They might send messages and post information in your name. They might access information about you that you recorded, thinking you would be the only person to see it. Obviously, preventing unauthorized access is high on the list of security issues that you must take seriously.

In many cases, such as logging in to a particular website, the use of a username/password combination is the only practical approach to user authentication, which makes password security paramount. Let's look at some issues related to passwords.

## Passwords

The username associated with an account is often not kept secret. Some systems allow you to make up your own username, whereas others make you use a specific identifier such as an email address. The idea is that an email address is generally specific to a particular person, and therefore can be associated uniquely with a particular account on their system. If a software system allows you to make up your own username, it checks the username against all currently used usernames in the system and, if someone has already claimed the one you want, forces you to pick another.

So while each username in a system is unique, the username itself does not provide any assurance of security. It's the combination of the username with a particular password that results in some confidence that you are who you say you are.

A password, of course, is a string of characters that supposedly only you, as the user of a particular account, know. Once the system verifies that the username you provide is valid and that the password you provide is associated with that username, then you are given the rights that only you should have as the "owner" of that account.

Password-based security mostly comes down to keeping your password out of other people's hands. You want to make sure no one can discover your password, such as finding it written down somewhere. You don't want to ever give a password to anyone, even someone you trust. And you want to make sure that no one can guess what your password is.



## RFID tags

RFID tags contain electronically stored tracking and identification information. They are powered by and read at short ranges by magnetic fields. Unlike bar codes, the tags do not need to be within the reader's line of sight. RFID tags are used in a wide variety of applications, from tracking the progress of a car through an assembly plant to returning lost pets to their owners.<sup>1</sup>

**Password criteria**

A set of rules that must be followed when creating a password

Here is a list of guidelines regarding password management:

- Create a password that is easy for you to remember but difficult for other people to guess.
- Don't use a simple password, especially one that relates to you personally, like your dog's name.
- Don't write down a password anywhere that other people can access.
- Use a combination of characters in the password, including both upper- and lowercase letters, digits, and special characters.
- Don't stay logged into an account and then walk away from your computer.
- Don't ever tell anyone your password. There should never be a valid reason for you to do so.
- Don't send your password in an email. Most email is sent "in the clear" with no encryption and could be easily intercepted.
- Don't use the same password for all of your online accounts. If one is compromised, then they all could be.

The first guideline in that list is key, and somewhat confounding. For convenience, you want to be able to remember your password easily, but if it is easy for you to remember, it might be easy for someone else (or a computer program) to guess unless you put some thought into it.

Simple words, or a simple combination of words, don't make a good password, especially if they have a direct connection to you. The password **yahtzee** might be easy for you to remember because it's your favorite game, but someone who knows you might try it. It would be nice to believe someone you know and trust would not try to access your account, but such assumptions are completely contrary to the concept of security and don't always match up with reality.

Even if you pick a word that doesn't relate to you personally, some computer programs are designed to break into your system by repeatedly trying different passwords using dictionaries with thousands of words. Your password should not resemble anything that looks like a word or phrase in English, or any other language that humans speak.

With that in mind, many software systems will insist that you create a password that has certain characteristics that make it more challenging to guess. These characteristics are called the **password criteria**. If your potential password does not meet the criteria, it is rejected until you enter one that does. A typical set of criteria for password creation might be:

- The password must be six characters or longer.
- It must contain at least one uppercase and one lowercase letter.
- It must contain at least one digit.
- It must contain at least one special character, such as ! or %.



The following table contains examples of passwords at varying levels of security:

Password	Security Level
rollingrock	Poor
RollingRock	Slightly better
Rolling_Rock_63	Better
Ro11ing%ROCK!%63	Much better

You might not think that a password like `Ro11ing%ROCK!%63` would be easy to remember, but it is if you use particular techniques to come up with it. For example, if you always replace the letter `l` with the number `1`, and put second words in all caps, and separate words with the `%` character, then something you can easily remember gets mapped to a seemingly incomprehensible string of characters. The individual steps for creating it are not something someone would typically guess, but you'll have a fairly straightforward way of recalling it when needed.

And while you should not get in the habit of writing down your passwords, either on paper or electronically, if you have a large number of accounts to keep track of, some external support may be warranted. There are software programs, such as `1Password` and `RoboForm`, whose purpose is to keep track of your authentication information in a secure manner. These programs are referred to as **password management software**, although they often also help store and manage other information, such as credit card numbers and PINs. Information stored in password management software is encrypted and guarded by a master password. Many of these programs provide plug-ins to your web browser that let you access your information in a secure way without ever having to type in the password at all. Such programs should be evaluated and used with care, but they may provide a good solution for keeping track of security information for the active user.

**Password management software** A program that helps you manage sensitive data, such as passwords, in a secure manner

## CAPTCHA

Although username and password verification is used for the vast majority of software systems, other authentication techniques do come into play. These range from seemingly insignificant situations, such as posting a comment on a blog, to high-security systems that use multiple levels of authorization.





**FIGURE 17.3** A CAPTCHA form verification

Courtesy of Google

**CAPTCHA**, for instance, is a system used to ensure that the information provided through a web form has been filled in by a person as opposed to a computer program. For example, some blogging software will employ CAPTCHA before a user submits a comment to prevent a malicious program from posting comments containing spam or other inappropriate material. In this case, the authorization process is not used to determine which specific human is participating, but simply that the participant IS a human.

CAPTCHA software is designed to present a problem easy enough for all humans to solve but difficult for an automated program to complete. The name CAPTCHA is a play on the word “capture,” and is an acronym for “Completely Automated Public Turing test to tell Computers and Humans Apart.”

Most modern CAPTCHA techniques involve presenting the user with an image of a word, phrase, or string of characters and then asking the user to type them in. The image of the word is theoretically easy to decipher by a human but distorted in various ways to make it difficult for a program to “read” the word. **FIGURE 17.3** shows an example of a CAPTCHA image.

If the user enters the word or phrase that matches the CAPTCHA image, then the form content is accepted; if not, it is rejected. Sometimes CAPTCHA images are hard even for a human to read, so most systems will provide an alternative image if needed.

A website developer can get CAPTCHA plug-ins from various places. The version pictured in Figure 17.3 is from the reCAPTCHA project, which, in addition to providing the standard CAPTCHA service, is designed to help digitize books. Instead of presenting random words, the reCAPTCHA system presents words that an optical character reader had difficulty deciphering. When the user types in the words (using human perceptual abilities), that information is also passed along to the digitizing organization. The reCAPTCHA system reportedly displays more than 100 million forms per day.

**CAPTCHA** A software mechanism used to verify that a web form is submitted by a human and not an automated program

### Fingerprint analysis

A technique used for user authentication that compares a scanned fingerprint to a stored copy of the authorized user's fingerprint

## Fingerprint Analysis

As discussed earlier, other techniques for user authorization include state-of-the-art techniques such as **fingerprint analysis**. Fingerprints, of course, are used to verify the identity of a particular person. Fingerprint analysis is considered a much stronger level of verification than username and password because it relies not only on information the user provides, but also on inherent characteristics of the user himself or herself.



**FIGURE 17.4** A fingerprint scanner

© LongHa2006/Getty Images

Fingerprint analysis requires the use of a scanner to read the fingerprint, as well as software to compare it to the fingerprint stored in the computer of the authorized user. This approach has dropped in cost so much over recent years that it is becoming much more popular.

Some modern laptop computers have fingerprint scanner hardware incorporated into the computer itself, often near the trackpad. Users verify themselves by passing their finger over the scanner before any access is granted. For other systems, the scanner is a small but separate peripheral device connected to a computer via a USB port. **FIGURE 17.4** shows a fingerprint-scanning peripheral.

Newer versions of the Apple iPhone incorporate Touch ID, Apple's own fingerprint recognition technology. Touch ID is built into the Home button of the phone. You can unlock your phone simply by placing your finger gently on the button—you don't have to type in your passcode. The Touch ID system occasionally has problems recognizing users, but most issues can be avoided by keeping the scanner clean and making sure the initial scan of the fingerprint is done carefully, using multiple scans with different finger orientations.

## 17.3 Malicious Code

We'll now explore deliberate attempts to gain inappropriate access or cause other problems using software. **Malicious code**, or *malware*, can be defined as any program code that explicitly attempts to bypass appropriate

### Blaster

?

In August 2003, the Blaster worm spread quickly through computers running Microsoft operating systems. It was designed to replicate on any vulnerable machines it could find and launch a denial-of-service attack on Microsoft's update website. Users of infected machines often didn't realize they had become victims, but their computers quickly became sluggish and often forced a reboot. The worm affected about 500,000 computers. Microsoft announced a \$250,000 reward for information leading to the worm's creator. Although arrests were made of individuals thought to be responsible for Blaster variants, the worm's original creator was never caught.

### Malicious code

**(malware)** A computer program that attempts to bypass appropriate authorization safeguards and/or perform unauthorized functions

authorization safeguards and/or perform unauthorized functions. Such code is transferred to a computer across a network or from removable media such as USB memory sticks. Malicious code may cause serious damage, such as the destruction of data, or it may merely create a nuisance, such as popping up unwanted messages.

There are many categories of malicious code. The term *computer virus* is often used to describe any malicious code, although it's really just one type of problem. A **virus** is a program that embeds a copy of itself in another program. This "infected" file is referred to as the virus *host*. When the host is executed, the virus code runs as well.

A **worm** is self-replicating, like a virus, but does not require a host program to infect. The worm runs as a stand-alone program. A worm tends to cause problems on the networks it uses to send copies of itself to other systems, often by consuming bandwidth. In contrast, a virus tends to cause problems on a particular computer by corrupting or deleting files.

The famous story of the Trojan horse gives its name to another category of malicious code. In the myth, the Greeks built a giant wooden horse in which a small group of warriors hid themselves. After the Trojans took the horse into the city, the hidden warriors came out under cover of night, opened the city gates, and allowed the Greeks to conquer Troy.

In programming, a **Trojan horse** is a program that appears to be helpful in some way, but actually causes some kind of problem when executed. Even while the program is running, it may appear to the user as a benevolent resource, which makes it difficult to track down. Like a worm, a Trojan horse is a stand-alone program; like a virus, it tends to cause problems on the computer on which it is executing.

The final category of malware we'll examine is called a **logic bomb**, which is malicious code that executes when a specific system-oriented event occurs. It is often set to execute on a certain date and time, such as Friday the 13<sup>th</sup> or April Fools' Day, but it could be triggered by many kinds of events.

## Antivirus Software

Malware can be fought using **antivirus software**, which is specifically designed to detect and remove malicious code, or, better yet, prevent it from being installed on your computer in the first place. Antivirus software first became available in the mid-1980s, when virus creation became a problem. The name is a bit misleading in that modern antivirus software protects you from many kinds of malware, not just viruses.

**Virus** A malicious, self-replicating program that embeds itself into other code

**Worm** A malicious stand-alone program that often targets network resources

**Trojan horse** A malicious program disguised as a benevolent resource

**Logic bomb** A malicious program that is set up to execute when a specific system event occurs

**Antivirus software** Software designed to detect, remove, and/or prevent malicious software

There are dozens of competing developers of antivirus software: Norton, McAfee, and Symantec are three of the most popular brands. If you haven't done so already, you should research your antivirus software options carefully, then install and use your favorite.

Some antivirus software works using *signature detection*. This approach generally works only when a known malware program has been identified and analyzed. Signature detection software looks for recognizable patterns of particular malware within executable code. That is, once a piece of malware is identified, key patterns in the executable version are noted. Then, when you do a scan of your hard drive or try to install a new piece of software, the antivirus software attempts to find those patterns. If a match is found, an alarm is raised.

An extension of the signature detection approach to antivirus software uses *heuristics* to identify potentially malicious code. The trouble with some malware is that it might deliberately mutate to make itself less recognizable. A heuristic approach looks for more general patterns than the strict signature detection approach, so that it hopefully can detect an entire family of similar malware.

It's important that you keep your antivirus software up to date. The companies that make antivirus software are constantly updating their database of signatures and heuristics to detect new malware.

## Security Attacks

A computer system can be attacked in many different ways. Some attacks attempt to gain inappropriate access, whereas others exploit development flaws. Still others rely on the vulnerabilities of digital communication. Let's examine the general characteristics of each type.

Earlier in this chapter we discussed the importance of picking good passwords and keeping them well guarded. Some attacks perform **password guessing** by repeatedly trying to log in to a system or application using different passwords. It might be impractical for a human to try many passwords individually, but a computer program can attempt thousands of potential passwords each second in a "brute force" fashion. These programs will often try every word in an online dictionary, combinations of words, and various other character combinations, to see whether they can eventually find your password. To partially address this problem, some authentication systems will allow a user to attempt to enter a password only a few times without success, and then will terminate the session.

Instead of guessing a password, other attacks will attempt to trick you into divulging that information willingly. **Phishing** is a technique that uses

### Password guessing

An attempt to gain access to a computer system by methodically trying to determine a user's password

**Phishing** Using a web page to masquerade as part of a trusted system to trick users into revealing security information

a web page that looks like an official part of some trusted environment, but is actually a page designed to collect key information such as usernames and passwords. For example, you might receive an email, supposedly from eBay, suggesting that there is business you need to take care of and presenting a link for you to follow. The resulting web page would ask you to log in, but instead of giving you access to your eBay account, the page simply transmits that information to a malicious user who will use it to gain inappropriate access to your account.

Some phishing schemes are very clever and look very official. Beware of any situation in which you are contacted (instead of you initiating the contact) and requested to provide security information. That will almost never happen with a reputable company. And if you are ever sent an email containing a link they encourage you to follow, scrutinize the link's true destination (the URL) carefully. (You can usually hover the mouse pointer over the link to show the URL.) That often gives away the fact that you would not be sent to a valid site.

Both password guessing and phishing are ways for a hacker to “spoof” a computer system. **Spoofing**, in general, is an attack that allows one user to masquerade as another.

A **back door** is a feature of a program that allows special access to a computer system or application, usually granting high levels of functional privileges. A programmer explicitly puts a back door into a system, perhaps for benign testing purposes, or perhaps for the unscrupulous intent to bypass the system security at a later point. In either case, a back door is a vulnerability that is deliberately integrated into a program and, therefore, might not raise any security flags. The key to protecting against back door attacks is a high-quality development process, in which careful code reviews by multiple participants minimize such abuses.

The development process can be the source of other security problems as well. A system defect, though unintentional, might allow a clever attacker to exploit the weakness. One such flaw allows a user to create a **buffer overflow**, which causes a program to crash and could leave the user in a state with increased authority levels—and thus with the ability to do things he or she couldn't do otherwise. A buffer is simply an area of memory of a particular size. If a program attempts to store more information than a buffer can accommodate, a system crash could occur.

This problem is another issue related to the quality of the development process. Programmers should carefully guard against the potential for buffer overflows. As a user, you should also make a point of staying current with updates to your programs. Often these updates contain fixes that eliminate potential security risks that eluded the initial quality assurance process during development.

**Spoofing** An attack on a computer system in which a malicious user masquerades as an authorized user

**Back door** A program feature that gives special and unauthorized access to a software system to anyone who knows it exists

**Buffer overflow** A defect in a computer program that could cause a system to crash and leave the user with heightened privileges

A **denial of service** (DoS) attack does not directly corrupt data or give inappropriate access. Instead, it renders a system essentially useless by keeping a valid user from being able to access the resource. Usually, a DoS attack is network based, caused by flooding a website or other network resource with communication packets that keep it so busy it cannot deal with authorized users. It may even cause the system itself to crash due to the sheer volume of requests for its attention.

Another network-based security problem is called the **man-in-the-middle** attack. Network communication goes through many locations and devices as it moves from its source to its destination. Usually, such communication is passed along as appropriate without a problem. A man-in-the-middle attack occurs when someone has access to the communication path at some point in the network and “listens,” usually with the help of a program, to the traffic as it goes by. The goal is to intercept key information, such as a password being transmitted as part of an email message. The encryption methods discussed in the previous section can guard against these problems.

## 17.4 Cryptography

A technical approach to keeping information secure can be discussed under the general umbrella of **cryptography**, which is the field of study related to encoded information. The word *cryptography* comes from the Greek term for “secret writing.” The basic concepts of cryptography have been used in one form or another for thousands of years to help people keep secrets from falling into the wrong hands. In this section, we explore the general issues related to cryptography, as well as some of the current cryptography approaches.

**Encryption** is the process of converting ordinary text, referred to as *plaintext* in cryptography terminology, into a form that is unreadable, called *ciphertext*. **Decryption** reverses this process, translating ciphertext into plaintext. A **cipher** is an algorithm used to perform a particular type of encryption and decryption. The key to a cipher is the set of particular parameters that guide the algorithm.

You might have played with ciphers of various kinds in the past. **Substitution ciphers**, as the name implies, substitute one character in the plaintext message with another character. To decode the message, the receiver performs the opposite substitution.

Perhaps the most famous substitution cipher is the **Caesar cipher**, used by Julius Caesar to communicate with his generals. The Caesar cipher simply shifts the characters of a message by a certain number of positions

### Denial of service

An attack on a network resource that prevents authorized users from accessing the system

### Man-in-the-middle

A security attack in which network communication is intercepted in an attempt to obtain key data

### Cryptography

The field of study related to encoded information

### Encryption

The process of converting plaintext into ciphertext

### Decryption

The process of converting ciphertext into plaintext

**Cipher** An algorithm used to encrypt and decrypt text

**Substitution cipher** A cipher that substitutes one character with another

**Caesar cipher** A substitution cipher that shifts characters a certain number of positions in the alphabet



**Big Brother**

The debate regarding encryption has been going on for decades. In the 1990s, the FBI began supporting a policy that required citizens to surrender deciphering keys upon request. The government also wanted the ability to gain access to secure information through back doors, bypassing the need for a deciphering key to access secure data. Privacy advocates protest against such encryption restrictions, arguing that the government's attempt to monitor encryption technology is Orwellian in nature. They also feel that back doors open up opportunities for hackers, and that powerful encryption helps keep confidential information out of the hands of criminals.

**Transposition cipher** A cipher that rearranges the order of the characters in a message

**Route cipher** A transposition cipher that lays out a message in a grid and traverses it in a particular way

**Cryptanalysis** The process of decrypting a message without knowing the cipher or key used to encrypt it

down the alphabet. For example, shifting the characters five positions to the right would result in the following substitutions:

Original: A B C D E F G H I J K L M N O P Q R S T U V W X Y Z  
Substitute: F G H I J K L M N O P Q R S T U V W X Y Z A B C D E

Using this approach, the message “MEET ME AT THE OLD BARN” would be encrypted as

RJJY RJ FY YMJ TQI GFWS

The key to this cipher consists of the number of characters shifted and the direction (right or left). Of course, the space character could be left out of the encrypted version or substituted with another character, and punctuation could be included. Many other variations of substitution ciphers exist as well, such as those in which groups of letters are substituted as a unit, or those that perform different substitutions at different points in the message.

**Transposition ciphers** rearrange the order of the existing characters in a message in a certain way. For example, a **route cipher** is a transposition cipher that lays out the message as a grid of characters and specifies a route through the grid to encrypt the information. To encrypt the message “MEET ME AT THE OLD BARN,” we could write the letters in columns as follows:

```
M T A H L A
E M T E D R
E E T O B N
```

We could encrypt this message by spiraling inward from the top right of the grid moving clockwise, yielding

ARNBOTEEMTAHLDETM

After being delivered, the message would be decrypted by recreating the grid and reading the letters down the columns. The key in this cipher is composed of the dimensions of the grid and the route used to encrypt the data. When making the grid, extra characters could be used as placeholders if the number of characters didn't work out perfectly for a particular grid dimension.

**Cryptanalysis** is the process of “breaking” a cryptographic code. That is, it is the attempt to figure out the plaintext version of a message without knowing the cipher or its key. Older approaches to cryptography, such as transposition and substitution ciphers, don't pose much of a challenge for modern computers. Programs have been written that can fairly easily determine which of these types of encryption methods are used and produce the corresponding plaintext messages. For modern computing, more sophisticated approaches are needed.

Another drawback to these approaches is that both the sender and the receiver must share the cipher key, yet it must be kept secret otherwise. This shared key is a weakness in the process because it must be communicated between the two parties and could be intercepted. If the key is compromised, all future encrypted messages are at risk.

Let's look at a modern approach to cryptography that minimizes these weaknesses. In **public-key cryptography**, each user has a pair of keys that are related mathematically. This relationship is so complex that a message encrypted with one key can be decrypted only with the corresponding partner key. One key is designated as the public key, which can be freely distributed, and the other key is the private key.

Encryption methods that use one key for encryption and decryption are called *symmetric*. Public-key encryption is not symmetric, which increases its security.

Suppose two users (say, Alice and Bob) want to communicate securely with each other. Keep in mind that they each have their own public and private key pair. To send a message to Bob, Alice first obtains Bob's public key, which he makes readily available, and uses it to encrypt her message. Now no one—not even Alice—can decrypt the message except Bob. Alice then sends the message safely to Bob, who decrypts it with his private key.

Likewise, Bob sends a message to Alice only after encrypting it with Alice's public key. Alice decrypts the message with her own private key. As long as both Alice and Bob keep their private keys to themselves, it doesn't matter who has their public keys.

Public-key encryption has also given rise to the use of **digital signatures**, which offer a way to "sign" a document by appending extra data to the message that is both unique to the sender and very difficult to forge. The digital signature allows the recipient to verify that the message truly originates from the stated sender and has not been altered by a third party during transmission. The signature is created using software that compresses the message into a form called a *message digest*, and then encrypts the message digest with the sender's private key. The receiver uses the sender's public key to decrypt the message digest and then compares it to the digest created from the message itself. If they match, the message is probably genuine and unaltered.

At the heart of public-key encryption is the fact that the public key can be made generally available and be freely distributed. But what if someone else creates a key pair using someone else's name? How can a receiver be sure that a public key is authentic? Organizations are handling this risk by creating a certificate authority center, which creates a **digital certificate** for each trusted sender. The certificate is made using the sender's personal data and authenticated public key. Then, when a new message arrives, it is verified using that digital certificate. If the message



#### Alan Turing: codebreaker

Alan Turing, often called the "father of computer science," was also a cryptanalyst. During World War II, Turing worked for the head of Britain's code-breaking center and was head of the section responsible for German naval cryptanalysis. He was instrumental in cracking the codes produced by the German cipher machine called *Enigma*, allowing the Allied forces to decrypt a large number of messages sent by the German military. This intelligence gave a significant advantage to the Allies during the war.

#### Public-key cryptography

An approach to cryptography in which each user has two related keys, one public and one private

**Digital signature** Data that is appended to a message, made from the message itself and the sender's private key, to ensure the authenticity of the message

**Digital certificate** A representation of a sender's authenticated public key used to minimize malicious forgeries



comes from someone for whom you don't have a digital certificate, you then have to decide whether to trust the message.

## 17.5 Protecting Your Information Online

We live in an online world. We shop online (see E-Commerce, Chapter 14), we store our information online (Cloud Computing, Chapter 15), and we socialize online (Social Media Evolution, Chapter 16). It's convenient and productive and fun.

The trouble is, to have all of those wonderful interactions, we regularly put information online that in years past we might have only entrusted to a close friend, if anyone. Online interaction comes with a huge burden of responsibility to be smart about the information we make available.

This issue goes beyond making sure no one steals a credit card number or a password. When it comes to outlets such as blogs and Facebook posts, people regularly share information that they would never share one-on-one with certain individuals, even if those individuals can access that information just as easily as anyone else.

According to a 2018 report by one cyber security company<sup>10</sup>:

- A hacker attack occurs every 39 seconds, affecting one in three Americans.
- 43% of cyber attacks target small business.
- Approximately \$1 trillion is expected to be spent globally on cyber security from 2017 to 2021.
- Only 38% of global organizations claim they are prepared to handle a sophisticated cyber attack.

These statistics stress the need to do everything we can to protect our online information.

One problem is that users of the Internet don't know about simple measures they can take to reinforce the privacy of their data. Social media applications such as Facebook have settings that allow users to control who can see what. But many people simply assume the default settings are what they want, or worse, don't know the settings even exist.

Why do people make mistakes when it comes to keeping online information secure? Some of the reasons include:

- The Internet can create a false sense of anonymity.
- People make assumptions about how securely their information is being treated.
- People don't think about the ramifications of sharing particular information in particular ways.

### ?

#### Words with Friends

Actor Alec Baldwin was removed from an American Airlines flight in December 2013 for refusing to turn off his cell phone when passengers were requested to do so. Apparently he was playing Words with Friends, a Scrabble-like game, and didn't want to quit. When CNN anchor Brooke Baldwin (no relation) tagged Alec Baldwin in a tweet asking about Words with Friends, the actor replied, "It's . . . well . . . addicting."<sup>2,3</sup>

The Internet puts a level of technology between us and the people with whom we interact. That distance is often welcome, but it's as much psychological as it is physical. The perceived distance can create a feeling that you're somehow protected by the technology—that you're in some ways anonymous—when the truth is that as a society, we're making more information about our private lives public than ever before.

In general, when it comes to posting online information, you should remember that you can't take it back. Once it's out there, it gets copied and archived and distributed in numerous ways. A recent survey noted that almost half of Internet users have regretted making certain information available online.

When you're having a face-to-face conversation with another person, you receive immediate feedback in numerous ways: direct responses, facial cues, and so forth. Typed responses, even with immediate feedback such as a text message, can easily lead to misinterpretations that might never have happened with personal interaction. This is not to say that remote interaction is bad; the point is that we should be aware of the limitations of online communication.

Many websites request that users create a unique account so that you can log in and personalize the process. In many cases, this is an important step and can result in a better online experience. The trouble is that we have become so used to such requests now that we are often too quick to give up that kind of information. Not all websites and online organizations are created equal. While it's not fun, it is often well worth the effort to investigate the security practices of the site. For example, a site's **security policy** should state that your information would never be shared with a third party, or at least list the situations in which it might be. That information provides a basis on which you can judge the risk. Informally, you should inquire about a new site with friends and objective references to give you a basis on which to make a decision.

Finally, it's important to think about how some information can be used against you, even if you have the best intent when posting it. A Facebook post that tells everyone you're excited about going on vacation next week also tells a potential thief that you'll be out of the house. A tweet that you're running late to pick up your child lets other people know that the child currently might be unprotected. You might think this information is only being seen by your close friends and family, but that is often not the case, and possibly unwise to post even if it is.

**Security policy** A written statement describing the constraints or behavior an organization embraces regarding the information provided by its users

## Corporate Responsibility

Of course, even if we as users do everything we can to protect our data, it won't matter much unless the companies providing social media environments do everything they can to protect their users' data. In March 2018, Facebook admitted that Cambridge Analytica, a data analysis firm, had used data that had been collected from 50 million Facebook users without their consent.

Cambridge Analytica works with political candidates to build psychological profiles of voters to help their clients win elections. The company had close ties to Donald Trump's 2016 election campaign and is accused of obtaining the data from Facebook under the guise that it would be used strictly for academic purposes. The breach came to light when Christopher Wylie, who worked at Cambridge Analytica, became a whistleblower, alerting the world to their misappropriated data.

Facebook claimed that there was no actual data breach, no systems were infiltrated, and no passwords were stolen. Facebook says that its users gave their consent for the data to be accessed when they signed up for certain apps, such as the one that was exploited for data collection in this case.

Facebook's stock dropped dramatically after the revelation. Lawmakers began demanding that Facebook CEO Mark Zuckerberg testify before Congress regarding the incident and the company's plans to improve security. At the time of this writing, the full ramifications of this incident were just beginning to unfold.

## Security and Portable Devices

Today, mobile computing devices such as smart phones, tablets, and laptops are essential equipment for most people. We are no longer restricted in our movement, even when we want to read email and surf the Web. Add **GPS** capabilities to the mix, and we can now make use of location-based services such as FourSquare and ensure that we don't get lost. Advertisements are even tailored to our location.

This flexibility also comes with new security challenges. Recently, several mobile service providers have been coming under scrutiny for their policies. In 2011, it became known that the Apple iPhone logs GPS data, cell information, and WiFi hotspot locations, and transmits that information to Apple every 12 hours. Phones that run the Android operating system keep track of similar data and transmit it to Google. The

### GPS (Global Positioning System)

A system that uses satellites to pinpoint the location of any GPS receiver

information is used for mapping programs and other apps, but is stored unencrypted and unprotected.

Law enforcement agencies have been making use of the data collected by these phones to aid in criminal investigations. Using that data, the movements of an individual can be tracked in detail. A device that reads the data from a phone can be purchased for less than \$3500, and manufacturers of such devices are encouraging police to make use of them.

A primary privacy concern is the circumstances under which law enforcement can gain access to that location history. The U.S. Customs and Border Protection (CBP) organization has publically asserted the authority to seize and copy the information stored in portable electronic devices for any reason. There have been reports of police gathering the information without a warrant during routine traffic stops.

With the advent of new and exciting technology comes the responsibility to wield it with care. On this issue, short of abandoning mobile devices altogether, the end user can do little other than encourage businesses and legislators to do the right thing.

## WikiLeaks

WikiLeaks is an organization whose goal is to disseminate secret and classified information to the public using the Web. As the name implies, the organization's website was originally designed as a **wiki**, allowing any users to upload information. It has evolved into an archival site for information gathered from specific sources. WikiLeaks is no longer a wiki.

The "wiki" prefix, especially now that WikiLeaks isn't a wiki, creates some confusion, as does the similarity of the WikiLeaks name to other sites. For example, Wikipedia, the popular online encyclopedia, is not related in any way to WikiLeaks.

The stated purpose of WikiLeaks is to provide a buffer between their sources, who are often anonymous news journalists and whistleblowers, and the governments that might put them in jail for making the information public. As an example, the WikiLeaks site refers to Chinese journalist Shi Tao, who was jailed in 2005 for publicizing an email from Chinese officials about the anniversary of the Tiananmen Square massacre.

By design, the administration of WikiLeaks makes it difficult for governments or other groups to influence their practices. WikiLeaks is an international, nonprofit organization. They no longer have an official headquarters—they operate offices out of countries such as Sweden and Switzerland, which have some of the strongest laws protecting the confi-

**Wiki** A website whose content can be created and edited by multiple users.

© Artur Debat/Getty Images; © Alan Dyer/Stocktrek Images/Getty Images

## Mavis Batey<sup>4, 5, 6</sup> Code Breaker

Mavis Batey was one of the original Bletchley Girls. Bletchley Park, a mansion in Milton Keynes, England, was the central site of the UK's Government Code and Cypher School (GC&CS) during World War II. Here in the lovely English countryside, the German Enigma and Lorenz ciphers were broken, shortening World War II considerably.

Born Mavis Lever, she studied German at University College London. In 1940 she decided to leave university, with the idea she would become a nurse to aid the war effort. However, she was told that her country needed her more for her German skills, so she began to work for GC&CS. After showing promise, she was sent to Bletchley Park, where she worked with the famous codebreaker Dilly Knox. Lever wrote, "*Organisation* is not a word you would associate with Dilly Knox. When I arrived, he said: 'Oh, hello, we're breaking machines; have you got a pencil?' That was it. I was never really told what to do."

In March of 1941, Lever deciphered a series of messages encrypted on the Italian navy's Enigma machine, which revealed Italy's detailed plans to ambush the Royal Navy supply convoy. The Italian Navy never again confronted the Royal Navy after that defeat.

In late 1941, Lever broke a message between Belgrade and Berlin that allowed the team to work out the wiring of the Abwehr Enigma

machine, which had been deemed impossible to break. This was of great importance. In the 1930s, the German spies who infiltrated Great Britain were caught and turned into double agents; however, British intelligence was uncertain as to whether the Germans still believed the misinformation being sent back by the double agents. The deciphered information confirmed that the Germans believed everything their double agents told them, including the information that the Allied Forces would invade at Calais. All this and Lever was only 19 years old.

Lever married Keith Batey, another of the Bletchley "break-in" experts whom she met when she sought help on a difficult problem. It wasn't until 1970 that the couple could tell their children what they did during the war. One of their daughters remarked that she always wondered why her mother was so good at Scrabble.

After the war, Mavis Batey spent time in Her Majesty's Diplomatic Service, then retired to raise their three children. She developed a fascination with gardening and published several books on garden history. She was made a Member of the Order of the British Empire (MBE) in 1987, not for her code breaking but for her preservation and conservation of gardens.

Batey died at age 92 on November 12, 2013.



dentiality between journalists and their sources. The WikiLeaks website is hosted on many servers spread throughout Europe.

The original sources of the information that WikiLeaks publishes vary, but a large percentage of the documents that they make available are related to United States government operations. For example, in July 2010, WikiLeaks posted almost 77,000 documents about the U.S. war in Afghanistan. In April 2011, they began publishing secret files relating to the prisoners held in the detention camp in Guantanamo Bay.

As you can imagine, this practice raises ethical issues and is a cause of concern for many people, including those in the U.S. military. Debate continues about the balance between the need for transparency in a free society and the need for secrecy to ensure the safety of those involved.

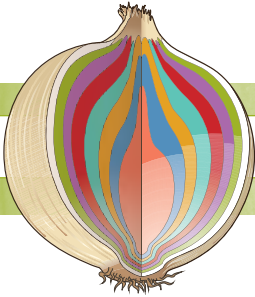
So it can be argued that WikiLeaks, by its stated purpose alone, is an example of an online security issue. Beyond that, though, is the simple fact that WikiLeaks is yet another organization that manages sensitive information online, making itself a target for hackers who attempt to gain inappropriate access.

Keep in mind that WikiLeaks archives a huge number of documents and makes conscious decisions about which documents to make public. In September of 2011, it became known that access to previously unpublished documents had been available for months. A large set of unredacted U.S. State Department documents had been archived on the WikiLeaks site and protected using an encryption key (as discussed in Section 17.4). Not only had the documents themselves been made available due to a hacker attack against WikiLeaks, but the decryption key was made available as well.

During the 2016 U.S. presidential primaries, WikiLeaks released emails from Democratic candidate Hillary Clinton from her time as Secretary of State under President Obama, which had been stored on a private email server. Some political scientists claim that the emails were strategically released to hurt Clinton's lead in the polls. Cybersecurity experts claimed that Russian intelligence was behind the hack of her email server and had provided the emails to WikiLeaks. WikiLeaks denied any cooperation with Russia regarding the leaks.

The founder of WikiLeaks, Julian Assange, is a former hacker and programmer. For many years he was constantly on the move, living for only a brief time in one of dozens of countries before moving on. In 2012, Ecuador granted Assange political asylum, and the Ecuadorian embassy in London has been his base of operations since. Over the course of its tumultuous relationship with WikiLeaks, the United States has considered various legal avenues against Assange but has not pursued them to date.

Several films about Assange and WikiLeaks were released between 2012 and 2014, including a thriller called *The Fifth Estate*, which was panned by critics and ignored by moviegoers. Assange opposed the making of *The Fifth Estate* and was reportedly pleased by its failure.



© Artur Debat/Getty Images, © Alan Dyer/Stocktrek Images/Getty Images

## SUMMARY

Security issues are prevalent throughout all of the layers of a computer system, and some have been explored in previous chapters. This chapter focused on high-level security issues that are faced by almost all users in today's online world.

Many of these issues fall under the umbrella of information security, which deals with the confidentiality, integrity, and availability of information. Confidentiality ensures that key data remains protected; integrity ensures that data can only be modified by appropriate mechanisms; and availability ensures that authorized users can access the data when needed.

Controlling access to computer systems and software requires user authentication, which uses some kind of user credentials to verify the user's identity. Authentication credentials could be something the user knows, like a password; something the user has, like a smart card; or a physical trait of the user, such as a fingerprint.

A good password is something you will remember that is difficult for other people to guess. Some systems require particular password criteria, such as a mix of upper- and lowercase letters, numeric digits, and special characters. In general, you shouldn't share your password with anyone, send it in an email, or use the same password for multiple accounts. Password management software helps keep track of information such as passwords and credit card numbers in a secure manner.

There are other techniques for controlling access besides username and password control. CAPTCHA is a software mechanism that ensures that the user is a human and not an automated program by having the user type in a string of characters viewed in a distorted image. Fingerprint analysis has become affordable recently and is often used to identify particular users using special hardware built into a laptop or as a USB peripheral device.

There are several categories of malicious code (or malware) that are designed to cause problems. They include viruses, which infect other



software and self-replicate; Trojan horses, which masquerade as beneficial software but have malicious intent; and logic bombs, which are designed to execute in response to a particular system event.

Antivirus software is used to detect, remove, and/or prevent malware. Despite its name, it protects the user from multiple kinds of malware, not just viruses. Antivirus software uses signature detection to identify particular threats, or heuristics that generalize the detection process to include families of similar threats.

Various types of security attacks include password guessing, phishing, and denial-of-service attacks. They also include programming-related problems, such as a programmer deliberately leaving “back door” access to a system and inadvertently creating a potential flaw such as a buffer overflow that could leave a user with inappropriately high privileges.

Cryptography is the field of study related to encoding information. Various ciphers can be used to encrypt and decrypt a message. A Caesar cipher and a transposition cipher are two early techniques that are relatively easy to break. Modern cryptography deals with public-key encryption, which has given rise to digital signatures and digital certificates.

The average user should make a better effort to protect their information online. Social network services such as Facebook and Google+ provide mechanisms for determining who can see what in terms of the data you make available, but many users don’t make use of these mechanisms, or don’t even know they exist. Poor decisions regarding online security stems from a false sense of anonymity and assumptions about the security policies of the websites involved.

Protecting data in mobile devices has become a recent problem. Companies like Apple and Google store location data on mobile phones. This data recently has been extracted and used by law enforcement and other sources without permission. This issue is currently in flux and will likely result in new policies and laws.

WikiLeaks is an organization that publishes secret and classified documents on the Web, while protecting the sources of that information from government retaliation. It operates in ways that make it difficult for anyone to influence its practices. While WikiLeaks promotes the need for transparency in a free society, their practices raise concerns, especially in the U.S. military. Furthermore, WikiLeaks was itself recently a target of an online attack that allowed a huge cache of unredacted U.S. State Department documents to be available for download.





## ETHICAL ISSUES

### Bloggging and Journalism

Like websites, blogs became ubiquitous virtually overnight. A blog is a weblog or online journal. Most blogs are interactive and provide for feedback from readers. Whereas most bloggers write about mundane matters, the blogosphere has also emerged as a viable alternative news medium. Blogs are having an increasing impact on the public, sometimes supplementing or correcting reporting of the mainstream media. For example, in 2004, blogs quickly exposed the inauthenticity of the documents used in a *60 Minutes* story about President George W. Bush's National Guard service. Many other blogs consistently provide a unique and unconventional perspective on the local and national news.

According to *The Wall Street Journal*, the audience for alternative media is expanding: "The number of Americans reading blogs jumped 58% in 2004 to an estimated 32 million people . . . with about 11 million looking to political blogs for news during the [2004] presidential campaign."<sup>7</sup> By March 2008, the number of people globally who read blogs was 346,000,000.

But blogs are not just for online journalists or political commentators. There are personal blogs, like the one being kept by the grandson of one of the authors. He is taking a year off after college to travel; his blog keeps family and friends in touch. There are corporate and organizational blogs, which enhance the communication and culture of the organization. Blogs can be sorted by genre, such as political blogs, travel blogs,

and classical music blogs; the list is endless. Blogs can be sorted by media type: They can contain videos, music, sketches, and photographs. Blogs also can be characterized by the device used to create them.

Of course, the blogosphere is not without its share of controversies. One such controversy erupted in 2005 after some bloggers posted confidential Apple Computer documents about an unreleased Apple product. Apple demanded to know the source of this information, but the bloggers argued that they were journalists, so they should be protected under federal and state laws from revealing their sources. A California judge disagreed, however, and ruled that the bloggers must reveal their sources.

Unfortunately, the judge in this case did not address the central question: Do bloggers deserve the same privileges to protect their sources that are accorded to journalists? On the one hand, these bloggers are acting just like journalists by reporting the news, so why shouldn't they have the same privileges as journalists? On the other hand, "the prospect of 10, 20, or 50 million bloggers claiming journalistic privilege terrifies judges and First Amendment lawyers alike, [since] they fear that anyone who has a website, if called to testify by a grand jury, could claim the privilege and refuse to cooperate."<sup>8</sup>

In early 2014, the U.S. Court of Appeals for the Ninth Circuit in San Francisco rendered a verdict that gives bloggers the same protection as journalists.



## ETHICAL ISSUES

### Blogging and Journalism (CONTINUED)

Because blogging is still a fairly new phenomenon, there has not been much debate about “blogging ethics.” But such debate is surely needed. What are the responsibilities of bloggers, especially those who operate alternative news sites? Do they have the same obligations as the conventional media? Should they be held to the same standards of objectivity? Although it may not be a good idea to put too many restrictions on bloggers, they are, of course, subject to the same ethical rules as anyone who communicates information: They must strive to be truthful at all times. They also have an obligation to check their sources and to identify those sources whenever possible so that readers are fully informed. In an online environ-

ment, this can often be done by providing links to other sites.

Bloggers also have a duty to avoid unjust accusations and to retract erroneous information as quickly as possible. Finally, bloggers should consider disclosing any conflicts of interest in cases where their objectivity may be compromised. Sometimes it may be necessary for a blogger to disclose who pays his or her salary, or who provides funding for the website’s operating costs. As one blogger explained, “The audience should be able to come to your blog and assume you’re not on the take.”<sup>9</sup> If bloggers can follow these simple rules, they will engender trust among their readers and the weblog will have a bright future.

© Artur Debat/Getty Images © Alan Dyer/Stocktrek Images/Getty Images

## KEY TERMS

Antivirus software  
 Authentication credentials  
 Availability  
 Back door  
 Biometrics  
 Buffer overflow  
 Caesar cipher  
 CAPTCHA  
 Cipher  
 Confidentiality  
 Cryptanalysis

Cryptography  
 Decryption  
 Denial of service  
 Digital certificate  
 Digital signature  
 Encryption  
 Fingerprint analysis  
 GPS (Global Positioning System)  
 Information security  
 Integrity  
 Logic bomb

**KEY TERMS (CONTINUED)**

Malicious code (malware)	Smart card
Man-in-the-middle	Spoofing
Password criteria	Substitution cipher
Password guessing	Transposition cipher
Password management software	Trojan horse
Phishing	User authentication
Public-key cryptography	Virus
Risk analysis	Wiki
Route cipher	Worm
Security policy	

**EXERCISES**

For Exercises 1–27, mark the answers true or false as follows:

- A. True
  - B. False
1. Information integrity ensures that data can be modified only by appropriate mechanisms.
  2. Pairing threats with vulnerabilities is a part of risk analysis.
  3. Smart cards are the most popular form of authentication credentials currently used.
  4. Biometrics is a type of user authentication that relies on the user having a smart card or a card with a readable magnetic strip.
  5. A password should not resemble anything that looks like a word or phrase in a language that humans speak.
  6. CAPTCHA is a software mechanism that authenticates a particular user before allowing him or her to post a comment to a blog.
  7. The reCAPTCHA project serves a secondary purpose—to help digitize books.
  8. The cost of fingerprint analysis has dropped significantly in recent years, and fingerprint analysis is now regularly built into laptop computers.
  9. The Touch ID biometric system uses retinal scans for user validation.
  10. A computer virus “infects” another program by embedding itself into that program.
  11. The terms “Trojan horse” and “worm” are used interchangeably to describe a particular category of malicious code.

**EXERCISES (CONTINUED)**

12. A logic bomb is set to go off when a particular system event occurs, such as a particular date and time.
  13. Antivirus software is not effective against non-virus types of malware.
  14. A password-guessing program uses dictionaries to try thousands of potential passwords each second.
  15. Phishing is a technique that uses deceptive emails and websites to obtain user information, such as usernames and passwords.
  16. A back door threat is implemented by a programmer of the system under attack.
  17. A denial-of-service attack does not directly corrupt data.
  18. Decryption is the process of converting plaintext into ciphertext.
  19. A cipher is an algorithm used to encrypt and decrypt text.
  20. A transposition cipher is an example of modern cryptography.
  21. In public-key cryptography, each user has two related keys, one public and one private.
  22. A digital signature allows the recipient to verify that the message truly originates from the stated sender.
  23. The Internet can create a false sense of anonymity.
  24. Users of social media sites make good use of the controls available to protect their information online.
  25. A website's security policy describes the constraints and behaviors that an organization embraces regarding information management.
  26. Many mobile phones collect and store location data that can then be read and used by third parties, such as law enforcement.
  27. WikiLeaks founder Julian Assange is currently in prison in the United States.
- Exercises 28–55 are problems or short-answer questions.
28. What is the CIA triad of information security?
  29. Other than those presented in this chapter, give three examples of data integrity violations.
  30. What are the three general approaches to presenting authorization credentials?
  31. List at least four guidelines related to password creation and management.
  32. Is “diningroom” a good password? Why or why not?
  33. Is “fatTony99” a good password? Why or why not?
  34. What is password management software?
  35. What is the goal of a CAPTCHA interaction?
  36. What are the dual purposes of the reCAPTCHA system?
  37. What is Apple's Touch ID technology used for?
  38. What do we mean when we say a computer virus is *self-replicating*?
  39. Describe the two techniques used by antivirus software to identify malware.

**EXERCISES (CONTINUED)**

40. Describe a hypothetical scenario, other than the one described in this chapter, of a phishing attack.
41. Describe how a Trojan horse attacks a computer system.
42. Describe a buffer overflow and how it might make a computer system vulnerable.
43. How does a man-in-the-middle attack work?
44. Using a Caesar cipher, shifting three letters to the right, encrypt the message "WE ESCAPE TONIGHT."
45. Using the Caesar cipher described in this chapter, decrypt the message "WJNSKTDWHJRJSYX FWWNAJ RTSIFD."
46. Using the transposition cipher technique used in this chapter, encrypt the message "WHO IS THE TRAITOR?"
47. Describe how Claire would send a message to David using public-key encryption.
48. What is a digital signature?
49. What does a website's security policy describe?
50. What is GPS? How is it used to support cell phone applications?
51. Which abuses are possible given the current state of cell phone data collection?
52. What is a wiki?
53. What is WikiLeaks? Is it a wiki?
54. Who is Julian Assange?
55. Describe the recent security issues regarding the WikiLeaks archives.

## THOUGHT QUESTIONS

1. Create and describe a process other than the one presented in this chapter for creating a password with a strong security level, but that would be easy for a person to remember. Give two examples that follow the process.
2. What is encryption, and how does it relate to you as a student?
3. Why do some people fail to keep their information secure online?
4. Find an example of a security policy posted on a website, and list three of the most important statements it makes regarding the management of information. Why do you think the statements you chose are important?
5. Describe the security issues related to the practice of collecting location data on mobile phones. Under which circumstances do you think that data should be collected and made available to other organizations?
6. Defend the goals of the WikiLeaks organization. Now describe how those goals can be harmful. Which goal is more important?
7. In your opinion, should restrictions be placed on bloggers? Should they be held to the same standards as journalists?
8. Is blogging an effective tool to communicate with the general public? Or does its individualistic stance and lack of an editor make it an unreliable source of information?
9. Is blogging only helpful in reporting news, or are there other valuable uses for weblogs?

## Laying the Groundwork

- 1 The Big Picture

## The Information Layer

- 2 Binary Values and Number Systems
- 3 Data Representation

## The Hardware Layer

- 4 Gates and Circuits
- 5 Computing Components

## The Programming Layer

- 6 Low-Level Programming Languages and Pseudocode
- 7 Problem Solving and Algorithms
- 8 Abstract Data Types and Subprograms
- 9 Object-Oriented Design and High-Level Programming Languages

## The Operating Systems Layer

- 10 Operating Systems
- 11 File Systems and Directories

## The Applications Layer

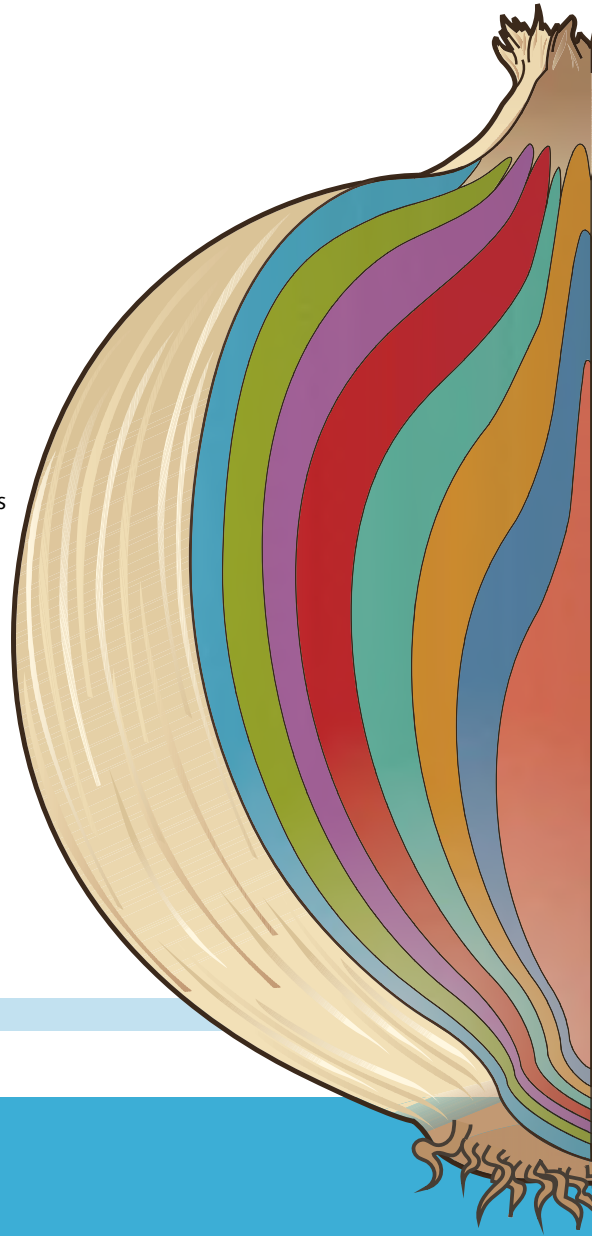
- 12 Information Systems
- 13 Artificial Intelligence
- 14 Simulation, Graphics, Gaming, and Other Applications

## The Communications Layer

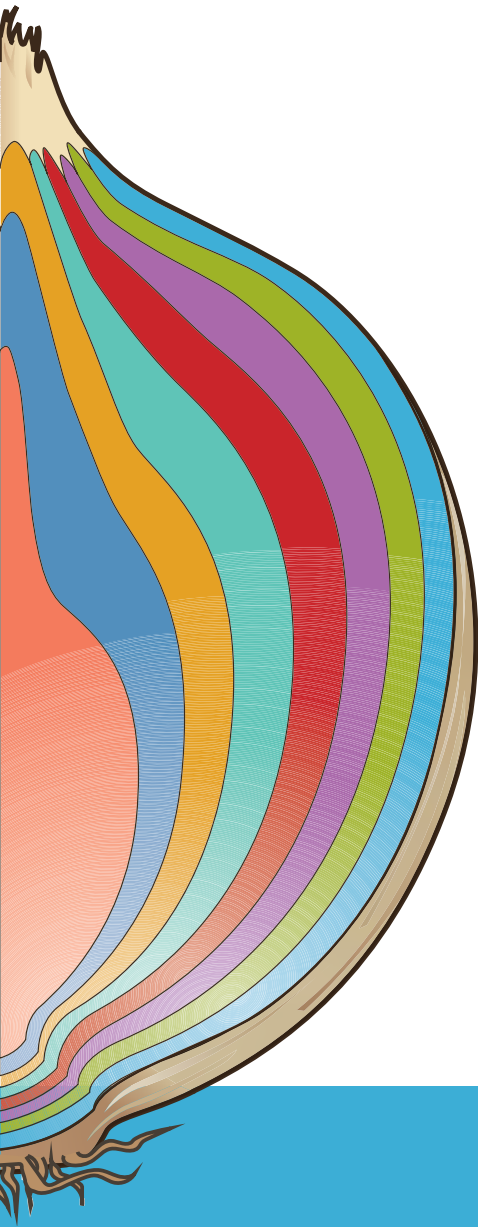
- 15 Networks
- 16 The World Wide Web
- 17 Computer Security

## In Conclusion

- 18 Limitations of Computing



# IN CONCLUSION



## 18

# LIMITATIONS OF COMPUTING

Over the previous 17 chapters, we have looked at computers: what they are, what they can do, and how to use them to solve problems. In this chapter, we look at what computers *cannot* do. That is, we examine the limits imposed by the hardware, the software, and the problems themselves. The dictionary gives multiple meanings for the word *limit*, including “boundary” and “something that is exasperating or intolerable.” We use both of these definitions of *limit* in this chapter.

Just as a roadblock stops traffic, the limits imposed by the hardware, software, and problems stop certain kinds of processing.

## GOALS

After studying this chapter, you should be able to:

- describe the limits that the hardware places on the solution to computing problems.
- discuss how the finiteness of the computer influences the solutions to numeric problems.
- discuss ways to ensure that errors in data transmission are detected.
- describe the limits that the software places on the solutions to computing problems.
- discuss ways to build better software.
- describe the limits inherent in computable problems themselves.
- discuss the continuum of problem complexity from problems in Class P to problems that are unsolvable.



## 18.1 Hardware

The limits on computing caused by hardware stem from several factors. One factor is that numbers are infinite, but the representation of them within the computer is not. Another problem with hardware is just the fact that it is hardware; that is, it is made up of mechanical and electronic components that can fail. Another set of problems occurs when data is transmitted from one internal device to another or from one computer to another. Let's look at each of these problems and some strategies to minimize their impact.

### Limits on Arithmetic

We discussed numbers and their representation in the computer in Chapters 2 and 3. There are limitations imposed by computer hardware on the representations of both integer numbers and real numbers.

#### Integer Numbers

In the Pep/9 machine discussed in Chapter 6, the register that is used for arithmetic is 16 bits long. We said that the largest value we could store there is 65,535 if we represent only positive values and 32,767 if we represent both positive and negative values. Pep/8 is a virtual machine—but what about real machines? If the word length is 32 bits, the range of integer numbers that can be represented is  $-2,147,483,648$  to  $2,147,483,647$ . Some hardware systems support long-word arithmetic, where the range is  $-9,223,372,036,854,775,808$  to  $9,223,372,036,854,775,807$ : Surely this is large enough for any calculation. Or is it?

Henry Walker, in his book *The Limits of Computing*, tells the following fable.<sup>1</sup> When the king asked a bright young dot-commer to undertake a task for him, she agreed to do it if the pay were adequate. She offered the king two choices: The king could pay her 1/5 of the crops produced in the kingdom for the next five years or base her payment on a chess board as follows:

- One kernel of corn on the first square
- Two kernels of corn on the second square
- Four kernels of corn on the third square
- Eight kernels of corn on the fourth square
- The kernels of corn would double on each successive square until the 64th square had been reached.

After a moment's thought, the king chose the second option. (Which would you have chosen?)

When it came time to pay up, the king started placing kernels of corn on the squares. There were 255 kernels on the first row ( $1 + 2 + 4 + 8 + 17$

+ 32 + 64 + 128); not too bad, he thought. For the next row, there were 65,280 kernels; still not too bad. The third row, however, with its 963,040 kernels of corn, made the king uneasy. During the counting of the next row, the king thought ahead to the last square, for he now understood the pattern. The 64th square alone would have  $2^{63}$  kernels of corn—roughly  $8 \times 10^{18}$  kernels or 110,000 billion bushels. The king abdicated his throne in light of such a staggering debt, and the mathematically sophisticated young woman became queen.

The moral of this story is that integer numbers can get very big very fast. If a computer word is 64 bits and we represent only positive numbers, we could just represent the number of kernels on the 64th square. If we tried to add up the kernels on the 64 squares, we could not do so. Overflow would occur.

The hardware of a particular machine determines the limits of the numbers, both real and integer, that can be represented. Some software solutions, however, allow programs to overcome these limitations. For example, we could represent a very large number as a list of smaller numbers. **FIGURE 18.1** shows how integers could be presented by putting one or more digits in each word. The program that manipulates integers in these forms would have to add each pair of digits beginning at the rightmost and add any carry into the next addition to the left.

## Real Numbers

In Chapter 3, we said that a real number is stored as an integer along with information about the position of the radix point. To better understand why real numbers pose a problem, let's look at a coding scheme that represents the digits and the *radix-point information*.

To simplify the following discussion, let's assume that we have a computer in which each memory location is the same size and is divided into a sign plus five decimal digits. When a variable or constant is defined, the location assigned to it consists of five digits and a sign. When an integral variable or constant is defined, the interpretation of the number stored in that place is straightforward. When a real variable is declared or a real constant is defined, the number stored there has both a whole-number part and a fractional part. The number must be coded to represent both parts.

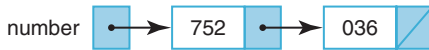
Let's see what these coded numbers might look like and what this coding does to arithmetic values in programs. We begin with integers. The range of the numbers we can represent with five digits is  $-99,999$  through  $+99,999$ :

-	9	9	9	9	9	Largest negative number
+	0	0	0	0	0	Zero
+	9	9	9	9	9	Largest positive number

(a) number = 752,036



(b) number = 752,036



(c) sum = 83,536 + 41

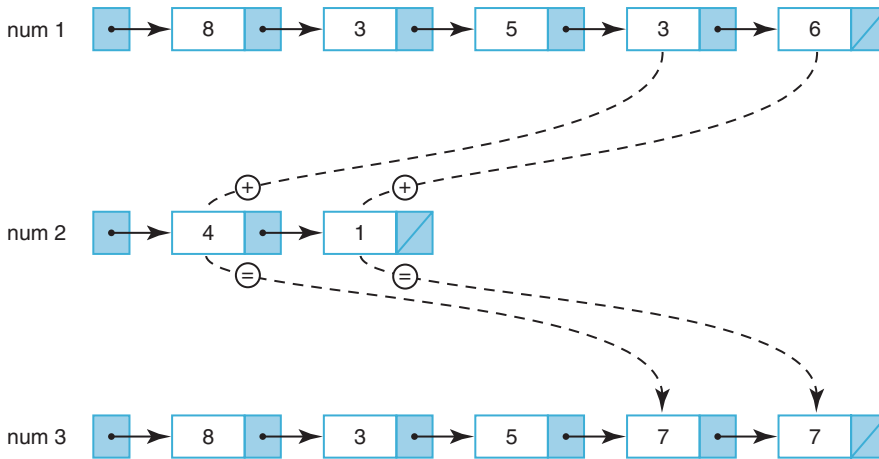


FIGURE 18.1 Representing very large numbers

**Precision** The maximum number of significant digits that can be represented

#### Significant digits

Those digits that begin with the first nonzero digit on the left and end with the last nonzero digit on the right (or a zero digit that is exact)

The **precision** (the maximum number of digits that can be represented) is five digits, and each number within that range can be represented exactly. What happens if we allow one of these digits (let's say the leftmost one, in red) to represent an exponent? For example,

+	3	2	3	4	5
---	---	---	---	---	---

represents the number  $+2345 \times 10^3$ . The range of numbers we can now represent is much larger:

$-9999 \times 10^9$  to  $+9999 \times 10^9$

or

$-9,999,000,000,000$  to  $+9,999,000,000,000$

Now the precision is only four digits. That is, we can represent only four **significant digits** (nonzero digits or zero digits that are exact) of the number itself. This means we can represent only four-digit numbers

exactly in our system. What happens to larger numbers? The four left-most digits are correct, and the balance of the digits is assumed to be zero. We lose the rightmost, or *least significant*, digits. The following example shows what happens.

Number	Sign	Exp.		Value
+99,999	+	1	9 9 9 9	+99,990
-999,999	-	2	9 9 9 9	-999,900
+1,000,000	+	3	1 0 0 0	+1,000,000
-4,932,416	-	3	4 9 3 2	-4,932,000

Notice that we can represent 1,000,000 exactly, but not -4,932,417. Our coding scheme is limited to four significant digits; the digits we cannot represent are assumed to be zero.

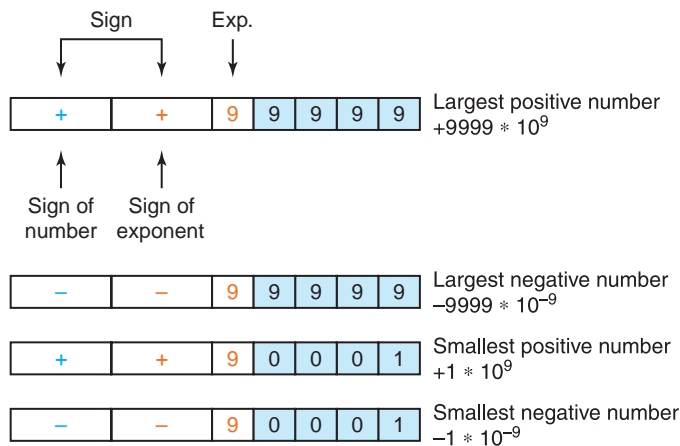
To extend our coding scheme to represent real numbers, we need to be able to represent negative exponents. For example,

$$4394 * 10^{-2} = 43.94$$

or

$$22 * 10^{-4} = 0.0022$$

Because our scheme does not allow for a sign for the exponent, we have to change the scheme slightly. Let's allow the sign that we have already been using to be the sign of the exponent and add a sign to the left of it to be the sign of the number itself.



Now we can represent all of the numbers between  $-9999 * 10^9$  and  $9999 * 10^9$  accurately to four digits, including all the fractional values.

### Privacy is expensive

?

In an opinion piece in the *New York Times*, reporter Julia Angwin asks if privacy has become a luxury. "But, as I have learned, it isn't cheap or convenient to start buying privacy," she writes. "I spend annoying amounts of time updating software or trying to resolve technical difficulties when my different privacy-protecting services conflict with one another."<sup>2</sup>

## Chapter 18: Limitations of Computing

Suppose we want to add three real numbers  $x$ ,  $y$ , and  $z$  using this coding scheme. We could add  $x$  to  $y$ , then add  $z$  to the result. Or we could do it another way: add  $y$  to  $z$ , then add  $x$  to the result. The associative law of arithmetic says that the two answers should be the same—but are they?

The computer limits the precision (the number of significant digits) of a real number. Using our coding scheme of four significant digits and an exponent, let's add the following allowable values of  $x$ ,  $y$ , and  $z$ :

$$x = -1324 * 10^3 \quad y = 1325 * 10^3 \quad z = 5424 * 10^0$$

First let's look at the result of adding  $z$  to the sum of  $x$  and  $y$ :

$$\begin{array}{r} \text{(x)} \quad -1324 * 10^3 \\ \text{(y)} \quad \quad 1325 * 10^3 \\ \hline \quad \quad 1 * 10^3 = 1000 * 10^0 \end{array}$$

$$\begin{array}{r} \text{(x + y)} \quad 1000 * 10^0 \\ \text{(z)} \quad \quad 5424 * 10^0 \\ \hline \quad \quad 6424 * 10^0 = (x + y) + z \end{array}$$

Now let's see what happens when we add  $x$  to the sum of  $y$  and  $z$ :

$$\begin{array}{r} \text{(y)} \quad 1325000 * 10^0 \\ \text{(z)} \quad \quad 5424 * 10^0 \\ \hline 1330424 * 10^0 = 1330 * 10^3 \text{ (truncated to four digits)} \end{array}$$

$$\begin{array}{r} \text{(y + z)} \quad 1330 * 10^3 \\ \text{(x)} \quad \quad -1324 * 10^3 \\ \hline \quad \quad 6 * 10^3 = 6000 * 10^0 = x + (y + z) \end{array}$$

### Representational (round-off) error

An arithmetic error caused by the fact that the precision of the result of an arithmetic operation is greater than the precision of our machine

**Underflow** The condition that occurs when the results of a calculation are too small to represent in a given machine

Our answers are the same in the thousands place but are different in the hundreds, tens, and ones places. This is called **representational error** or **round-off error**. The result of adding  $y$  to  $z$  gives us a number with seven digits of precision, but only four digits can be stored.

In addition to representational errors, there are two other problems to watch out for in floating-point arithmetic: underflow and overflow. **Underflow** is the condition that arises when the absolute value of a calculation gets too small to be represented. Going back to our decimal representation, let's look at a calculation involving very small numbers:

$$\begin{array}{r} 4210 * 10^{-8} \\ * 2000 * 10^{-8} \\ \hline 8420000 * 10^{-16} = 8420 * 10^{-13} \end{array}$$

This value cannot be represented in our scheme because the exponent  $-13$  is too small. Our minimum is  $-9$ . Therefore, the result of the calculation would be set to zero. Any value too small to be represented is set to zero, which is a reasonable thing to do under the circumstances.

**Overflow** is the condition that arises when the absolute value of a calculation gets too large to be represented. Overflow is a more serious problem because there is no logical thing to do when it occurs. For example, the result of the calculation

$$\begin{array}{r} 9999 * 10^9 \\ * 1000 * 10^9 \\ \hline 9999000 * 10^{18} = 9999 * 10^{21} \end{array}$$

cannot be stored. What should we do? To be consistent with our response to underflow, we could set the result to  $9999 * 10^9$ , the maximum real value allowed in our scheme. But this seems intuitively wrong. The alternative is to stop the computation and issue an error message.

Another type of error that can happen with floating-point numbers is **cancellation error**. This error happens when numbers of widely differing magnitudes are added or subtracted. Here's an example:

$$(1 + 0.00001234 - 1) = 0.00001234$$

The laws of arithmetic say this equation should be true. But what happens when the computer is doing the arithmetic?

$$\begin{array}{r} 100000000 * 10^{-8} \\ + 1234 * 10^{-8} \\ \hline 100001234 * 10^{-8} \end{array}$$

With four-digit accuracy, this becomes  $1000 * 10^{-3}$ . Now the computer subtracts 1:

$$\begin{array}{r} 1000 * 10^{-3} \\ - 1000 * 10^{-3} \\ \hline 0 \end{array}$$

The result is 0, not 0.00001234.

We have been discussing problems with real numbers, but integer numbers can also overflow (both negatively and positively). The moral of this discussion is twofold. First, the results of real calculations often are not what you expect. Second, if you are working with very large numbers or very small numbers, you need to be quite careful of the order in which you perform the calculations.

**Overflow** The condition that occurs when the results of a calculation are too large to represent in a given machine

**Cancellation error** A loss of accuracy during addition or subtraction of numbers of widely differing sizes, due to limits of precision

## Limits on Components

“My hard disk crashed.” “The file server was down.” “My email went down last night.” Any computing instructor has heard these tales of woe hundreds of time, as they are used to explain (excuse?) late assignments. Of course, if an assignment is started when it is handed out rather than the day it is due, these failures can be overcome. However, the problems of hardware failure do exist: Disks do crash, file servers do go down, and networks do fail. The *Titanic effect*, which states that “The severity with which a system fails is directly proportional to the intensity of the designer’s belief that it cannot,” was coined by J. A. N. Lee.<sup>3</sup> Hardware failures do occur; the best solution is preventive maintenance. In computing, this means periodic tests to detect problems and replacement of worn parts.

Preventive maintenance also means that the computer is housed in an appropriate physical environment. Large mainframe computers often require air-conditioned, dust-free rooms. PCs should not be set up under leak-prone plumbing. Alas, not all situations can be anticipated. One such situation occurred during the days prior to the advent of integrated circuits. A machine that had been working correctly started producing erratic results. The problem was finally traced to a moth that had gotten into the cabinet of the machine. This incident led to the term *bug* for a computer error. A more recent incident involved a DSL connection that intermittently disconnected itself. The trouble was finally traced to faulty telephone lines on which the local band of squirrels had enjoyed munching.

Of course, any discussion of component limits assumes that the computer hardware has been thoroughly tested at the design stage and during manufacturing. A major scandal in 1994 was the circuit flaw in Intel’s Pentium processor. The Pentium chip was installed in millions of computers manufactured by IBM, Compaq, Dell, Gateway 2000, and others. The circuit flaw was a design error in the floating-point unit that caused certain types of division problems involving more than five significant digits to give the wrong answer.

How often would the error affect a calculation? IBM predicted that spreadsheet users would experience an error every 24 days, Intel asserted that it would occur every 27,000 years, and *PC Week’s* test suite placed the frequency once every 2 months to 10 years.<sup>4</sup> The chip’s flaw was corrected, but Intel did not recall all of the already-released chips. The experience was a public relations disaster for Intel, but the company remains one of the leading chip manufacturers today.

### ?

#### Tweets useful to burglars

On Twitter, most user posts are public. So a burglar doesn’t have to be your “follower” to hear all about your vacation. And when you are on vacation, your house is most likely empty, ripe for a burglary.<sup>5</sup>

## Limits on Communications

The flow of data within a computer and between computers is the life blood of computing. Therefore, it is extremely important that the data not be corrupted in any way. This realization leads to strategies known as *error-detecting* and *error-correcting codes*. Error-detecting codes determine that an error has occurred during the transmission of data and alert the system to this fact. Error-correcting codes not only determine that an error has occurred, but also try to determine what the correct value actually is.

### Parity Bits

Parity bits are used to detect that an error has occurred between the storing and retrieving of a byte or the sending and receiving of a byte. A parity bit is an extra bit that is associated with each byte in the hardware that uses the scheme. This bit is used to ensure that the number of 1 bits in a 9-bit value (byte plus parity bit) is odd (or even) across all bytes.

*Odd parity* requires the number of 1s in a byte plus the parity bit to be odd. For example, if a byte contains the pattern 11001100, the parity bit would be 1, giving an odd number of 1s. If the pattern were 11110001, the parity bit would be 0, giving an even number of 1s. When a byte is retrieved from memory or received from a transmission, the number of 1 bits is counted (including the parity bit). If the number is even, an error has occurred. If this scheme is used in the hardware, each byte actually has an extra bit, accessible only by the hardware, that is used for error detection. *Even parity* uses the same scheme, but the number of 1 bits must be even.

### Check Digits

A software variation of the same scheme is to sum the individual digits of a number and then store the unit's digit of that sum with the number. For example, given the number 34376, the sum of the digits is 23, so the number would be stored as 34376-3. If the 4 became corrupted as a 3, the error would be detected. Of course, if the 7 were corrupted to a 6 and the 6 were corrupted to a 7, the sum would still be correct, but the number would not be.

This scheme could be expanded to carry an additional digit, perhaps the unit's digit of the sum of the odd digits. In this case, 34376 would be stored as 34376-23: 3 is the unit's digit, of the sum of all the digits, and 2 is the unit's digit of the sum of the first, third, and fifth digits. This technique would catch a transposition error between adjacent digits but would miss other transpositions. Of course, we could also carry the unit's digit of the



sum of the even digits. You get the idea. The more important it is for errors to be detected, the more complex the algorithm used to detect them is.

### Error-Correcting Codes

If we keep enough information about a byte or number, it becomes possible to deduce what an incorrect bit or digit must be. The ultimate redundancy would be to keep two separate copies of every value that is stored. If the parity is in error or there is an error in the check digits, we could look back at the extra copy to determine the correct value. Of course, both copies could be in error.

The major work in error-correcting codes relates to disk drives and CDs, where imperfections in the surface can corrupt data.

## 18.2 Software

We have all encountered horror stories about software that contained errors; they make for very interesting reading. Are software errors in running programs really common occurrences? Can't we do something to make software more error free? To answer the first question, a web search for "software bugs" retrieved 261,000,000 hits. To answer the second, software developers are trying. In the next few sections, we examine why error-free software is difficult—if not impossible—to produce. We also discuss current approaches to software quality, and we end with a collection of interesting bugs.

### Complexity of Software

If we accept the premise that commercial software contains errors, the logical question is "Why?" Don't software developers test their products? The problem is actually not a lack of diligence but rather our old nemesis *complexity*. As our machines have grown increasingly more powerful, the problems that can be tackled have become increasingly more complex. A single programmer with a problem moved to a programming team with a problem and finally graduated to a team of teams with a problem.

Software testing can demonstrate the presence of bugs but cannot prove their absence. We can test software, find errors and fix them, and then test the software some more. As we find problems and fix them, we raise our confidence that the software performs as it should. But we can never guarantee that we have removed all of the bugs. There is always the possibility of another bug lurking in the software that we haven't found yet.

?

#### Yes, Watson?

In 2014, IBM challenged mobile developers to use Watson as a cognitive computing engine for new smartphone apps. Watson is the computing platform that rose to fame when it beat two human champions of the TV game show *Jeopardy*. Watson "reads" millions of pages of information on many subjects and is able to answer questions about the information asked in natural language. Questions on *Jeopardy* are often tricky, which meant Watson had to sort through double meanings to come up with correct answers.<sup>6</sup>

Given that we can never know for sure if we have found all the problems, when do we stop testing? It becomes a question of risk. How much are you willing to risk that your software may hold yet another bug? If you're writing a game, you might take that risk a lot sooner than you would if you're writing airplane control software in which lives are on the line.

As Nancy Leveson points out in *Communications of the ACM*, a branch of computing known as *software engineering* emerged in the 1960s with the goal of introducing engineering discipline into the development of software.<sup>7</sup> Great strides toward this goal have been made over the past half-century, including a greater understanding of the role of abstraction, the introduction of modularity, and the notions of the software life cycle, which we discuss in detail later.

Most of these ideas come from engineering, but had to be adapted to the unique problems that arose when working with more abstract materials. Hardware designs are guided and limited by the nature of materials used to implement these designs. Software appears to have limits that are related more closely to human abilities than to physical limitations. Leveson continues, "Thus, the first 50 years may be characterized as our learning about the limits of our field, which are intimately bound up with the limits of complexity with which humans can cope."

Building software has changed. The early days were filled with the drive to write new software, but more and more the problems of maintaining and evolving existing software have taken center stage. As our systems have grown bigger and required large teams of designers, we have started to examine the ways humans collaborate and to devise ways to assist them to work together more effectively.

## Current Approaches to Software Quality

Although the complexity of large software systems makes error-free products almost an impossibility, it doesn't mean that we should just give up. There are strategies that we can adopt that, if used, improve the quality of software.

### Software Engineering

In Chapter 7, we outlined four stages of computer problem solving: write the specification, develop the algorithm, implement the algorithm, and maintain the program. When we move from small, well-defined tasks to large software projects, we need to add two extra layers on top of these:

**Software**

**requirements** A statement of what is to be provided by a computer system or software product

**Software**

**specification** A detailed description of the function, inputs, processing, outputs, and special features of a software product; it provides the information needed to design and implement the software

software *requirements* and *specifications*. **Software requirements** are broad, but precise, statements outlining what is to be provided by the software product. **Software specifications** are a detailed description of the function, inputs, processing, outputs, and special features of a software product. The specifications tell *what* the program does, but not *how* it does it.

Leveson mentions the software life cycle as part of the contributions of software engineering. The *software life cycle* is the concept that software is developed, not just coded, and evolves over time. Thus the life cycle includes the following phases:

- Requirements
- Specifications
- Design (high-level and lower-level)
- Implementation
- Maintenance

Verification activities must be carried out during all of these phases. Do the requirements accurately reflect what is needed? Do the specifications accurately reflect the functionality needed to meet the requirements? Does the high-level design accurately reflect the functionality of the specifications? Does each succeeding level of design accurately implement the level above? Does the implementation accurately code the designs? Do changes implemented during the maintenance phase accurately reflect the desired changes? Are the implementations of these changes correct?

In Chapters 6 and 7, we discussed the testing of the designs and code for the relatively small problems presented in this book. Clearly, as the problems get larger, verification activities become more important and more complex. (Yes, *that* word again.) Testing the design and finished code is only a small—albeit important—part of the process. Half the errors in a typical project occur in the design phase; only half occur in the implementation phase. This data is somewhat misleading. In terms of the cost to *fix* an error, the earlier in the design process an error is caught, the cheaper it is to correct the error.<sup>8</sup>

Teams of programmers produce large software products. Two verification techniques effectively used by programming teams are design or code walk-throughs and inspections. These are formal team activities, the intention of which is to move the responsibility for uncovering errors from the individual programmer to the group. Because testing is time-consuming and errors cost more the later they are discovered, the goal is to identify errors before testing begins.

In a **walk-through**, the team performs a manual simulation of the design or program with sample test inputs, keeping track of the program's data by hand on paper or a blackboard. Unlike thorough program testing, the walk-through is not intended to simulate all possible test cases. Instead, its purpose is to stimulate discussion about the way the programmer chose to design or implement the program's requirements.

At an **inspection**, a reader (never the program's author) goes through the requirements, design, or code line by line. The inspection participants are given the material in advance and are expected to have reviewed it carefully. During the inspection, the participants point out errors, which are recorded on an inspection report. Team members, during their pre-inspection preparation, will have noted many of the errors. Just the process of reading aloud will uncover other errors. As with the walk-through, the chief benefit of the team meeting is the discussion that takes place among team members. This interaction among programmers, testers, and other team members can uncover many program errors long before the testing stage begins.

At the high-level design stage, the design should be compared to the program requirements to make sure that all required functions have been included and that this program or module works correctly in conjunction with other software in the system. At the low-level design stage, when the design has been filled out with more details, it should be inspected yet again before it is implemented. When the coding has been completed, the compiled listings should be inspected again. This inspection (or walk-through) ensures that the implementation is consistent with both the requirements and the design. Successful completion of this inspection means that testing of the program can begin.

Walk-throughs and inspections should be carried out in as nonthreatening a way as possible. The focus of these group activities is on removing defects in the product, not on criticizing the technical approach of the author of the design or the code. Because these activities are led by a moderator who is not the author, the focus is on the errors, not the people involved.

Over the past 10 to 20 years, the Software Engineering Institute at Carnegie Mellon University has played a major role in supporting research into formalizing the inspection process in large software projects, including sponsoring workshops and conferences. A paper presented at the SEI Software Engineering Process Group (SEPG) Conference reported on a project that was able to reduce product defects by 86.6% using a two-tiered inspection process of group walk-throughs and formal inspections. The process was applied to packets of requirements, design, or code

**Walk-through A**  
verification method in which a team performs a manual simulation of the program or design

**Inspection A**  
verification method in which one member of a team reads the program or design aloud line by line and the others point out errors

TABLE

### 18.1 Errors found during a maintenance project

© Artur Debat/Getty Images, © Alan Dyet/Stocktrek Images/Getty Images

Stage	Defects per KSLOC
System design	2
Software requirements	8
Design	12
Code inspection	34
Testing activities	3

at every stage of the life cycle. TABLE 18.1 shows the defects per 1000 source lines of code (KSLOC) that were found in the different phases of the software life cycle in a maintenance project.<sup>9</sup> During the maintenance phase, 40,000 lines of source code were added to a program with more than half a million lines of code. The formal inspection process was used in all of the phases except testing activities.

We have talked about large software projects. Before we leave this section, let's quantify what we mean by "large." The Space Shuttle Ground Processing System has more than 500,000 lines of code; Vista has 50 million lines of code. Most large projects fall somewhere in between.

We have pointed out that the complexity of large projects makes the goal of error-free code almost impossible to attain. The following is a guideline for the number of errors per lines of code that can be expected:<sup>10</sup>

Standard software: 25 bugs per 1000 lines of program

Good software: 2 errors per 1000 lines

Space Shuttle software: < 1 error per 10,000 lines

## Formal Verification

It would be nice if we could use a tool to automatically locate the errors in a design or code without our even having to run the program. That sounds unlikely, but consider an analogy from geometry. We wouldn't try to prove the Pythagorean theorem by proving that it worked on every triangle—that would simply demonstrate that the theorem works for every triangle *we tried*. We prove theorems in geometry mathematically. Why can't we do the same for computer programs?

The verification of program correctness, independent of data testing, is an important area of theoretical computer science research. The goal of this research is to establish a method for proving programs that is analogous to the method for proving theorems in geometry. The necessary techniques exist for proving that code meets its specifications, but the proofs are often more complicated than the programs themselves. Therefore, a major focus of verification research is the attempt to build automated program provers—verifiable programs that verify other programs.

Formal methods have been used successfully in verifying the correctness of computer chips. One notable example is the verification of a chip to perform real-number arithmetic, which won the Queen's Award for Technological Achievement. Formal verification to prove that the chip

met its specifications was carried out by C. A. R. Hoare, head of the Programming Research Group of Oxford University, together with MOS Ltd. In parallel, a more traditional testing approach was taking place. As reported in *Computing Research News*:

The race [between the two groups] was won by the formal development method—it was completed an estimated 12 months ahead of what otherwise would have been achievable. Moreover, the formal design pointed to a number of errors in the informal one that had not shown up in months of testing. The final design was of higher quality, cheaper, and was completed quicker.<sup>11</sup>

It is hoped that success with formal verification techniques at the hardware level will eventually lead to success at the software level. However, software is far more complex than hardware, so we do not anticipate any major breakthroughs within the near future.

## Open-Source Movement<sup>12</sup>

In the early days of computing, software came bundled with the computer, including the source code for the software. Programmers adjusted and adapted the programs and happily shared the improvements they made. In the 1970s, firms began withholding the source code, and software became big business.

With the advent of the Internet, programmers from all over the world can collaborate at almost no cost. A simple version of a software product can be made available via the Internet. Programmers interested in extending or improving the program can do so. A “benevolent dictator” who keeps track of what is going on governs most open-source projects. If a change or improvement passes the peer review of fellow developers and gets incorporated into the next version, it is a great coup.

Linux is the best-known open-source project. Linus Torvolds wrote the first simple version of the operating system using UNIX as a blueprint and continued to oversee its development. IBM spent \$1 billion on Linux in 2001 with the objective of making it a computing standard. As *The Economist* says,

Some people like to dismiss Linux as nothing more than a happy accident, but the program looks more like a textbook example of an emerging pattern. . . . Open source is certainly a mass phenomenon, with tens of thousands of volunteer programmers across the world already taking part, and more joining in all the time, particularly in countries such as China and India. SourceForge, a website for developers, now hosts more than 18,000 open-source projects that keep 145,000 programmers busy.<sup>14</sup>

### Dijkstra decried the term “bugs”

Ever since the first moth was found in the hardware, computer errors have been called *bugs*. Edsger Dijkstra chided us for the use of this terminology. He said that it can foster the image that errors are beyond the control of the programmer—that a bug might maliciously creep into a program when no one is looking. He contended that this perspective is intellectually dishonest because it disguises the fact that the error is the programmer’s own creation.<sup>13</sup>

## Chapter 18: Limitations of Computing

Now, 14 years later, open source is still going strong. Some companies consider it one of several design choices; others consider it critical to their operations. As of May 2013, SourceForge had more than 300,000 software projects registered and more than 3 million registered users. By 2014, OpenSSL, an open-source implementation of a set of encryption tools founded in 1998, was used in two-thirds of all web servers. A 2013 report by Coverity, a company specializing in software quality and security testing solutions, showed that open source software had fewer errors per thousand lines of code (KLOC) than proprietary software.<sup>15,16</sup>

Unfortunately, in April 2014 a bug, popularly known as *Heartbleed*, was found in OpenSSL. It was quickly fixed, but it brought attention to the volunteer programmers who drive the open-source movement. Theoretically, each checks another's work, leading to better software. Clearly, this did not happen in the case of Heartbleed.<sup>17</sup>

### Notorious Software Errors

Everyone involved in computing has a favorite software horror story. We include only a small sample here.

#### AT&T Down for Nine Hours

In January 1990, AT&T's long-distance telephone network came to a screeching halt for nine hours because of a software error in the electronic switching systems. Of the 148 million long-distance and toll-free calls placed with AT&T that day, only 50% got through. This failure caused untold collateral damage:

- Hotels lost bookings.
- Rental car agencies lost rentals.
- American Airlines' reservation system traffic fell by two-thirds.
- A telemarketing company lost \$75,000 in estimated sales.
- MasterCard couldn't process its typical 200,000 credit approvals.
- AT&T lost some \$60 million to \$75 million.

As AT&T Chairman Robert Allen said, "It was the worst nightmare I've had in 32 years in the business."<sup>18</sup>

How did this happen? Earlier versions of the switching software worked correctly. The software error was in the code that upgraded the system to make it respond more quickly to a malfunctioning switch. The error involved a *break* statement in the C code.<sup>19</sup> As Henry Walker points out in



*The Limits of Computing*, this breakdown illustrates several points common to many software failures. The software had been tested extensively before its release, and it worked correctly for about a month. In addition to testing, code reviews had been conducted during development. One programmer made the error, but many others reviewed the code without noticing the error. The failure was triggered by a relatively uncommon sequence of events, difficult to anticipate in advance. And the error occurred in code designed to improve a correctly working system—that is, it arose during the maintenance phase. E. N. Adams in the *IBM Journal of Research and Development* estimates that 15 to 50% of attempts to remove an error from a large program result in the introduction of additional errors.

### Therac-25

One of the most widely cited software-related accidents involved a computerized radiation therapy machine called the *Therac-25*. Between June 1985 and January 1987, six known accidents involved massive overdoses by the Therac-25, leading to deaths and serious injuries. These accidents have been described as the worst series of radiation accidents in the 35-year history of medical accelerators.

We look more closely at these incidents in the “Ethical Issues” section at the end of this chapter.

### Bugs in Government Projects

On February 25, 1991, during the first Gulf War, a Scud missile struck a U.S. Army barracks, killing 28 soldiers and injuring roughly 100 other people. A U.S. Patriot Missile battery in Dhahran, Saudi Arabia, failed to track and intercept the incoming Iraqi Scud missile because of a software error. This error, however, was not a coding error but a design error. A calculation involved a multiplication by  $1/10$ , which is a nonterminating number in binary. The resulting arithmetic error accumulated over the 100 hours of the batteries’ operation amounted to 0.34 second, enough for the missile to miss its target.<sup>20</sup>

The General Accounting Office concluded:

The Patriot had never before been used to defend against Scud missiles nor was it expected to operate continuously for long periods of time. Two weeks before the incident, Army officials received Israeli data indicating some loss in accuracy after the



system had been running for 8 consecutive hours. Consequently, Army officials modified the software to improve the system's accuracy. However, the modified software did not reach Dhahran until February 26, 1991—the day after the Scud incident.”<sup>21</sup>

The Gemini V missed its expected landing point by about 100 miles. The reason? The design of the guidance system did not take into account the need to compensate for the motion of the Earth around the Sun.<sup>22</sup>

In October 1999, the Mars Climate Orbiter entered the Martian atmosphere about 100 kilometers lower than expected, causing the craft to burn up. Arthur Stephenson, chairman of the Mars Climate Orbiter Mission Failure Investigation Board, concluded:

The “root cause” of the loss of the spacecraft was the failed translation of English units into metric units in a segment of ground-based, navigation-related mission software, as NASA has previously announced . . . The failure review board has identified other significant factors that allowed this error to be born, and then let it linger and propagate to the point where it resulted in a major error in our understanding of the spacecraft's path as it approached Mars.<sup>23</sup>

Launched in July 1962, the Mariner 1 Venus probe veered off course almost immediately and had to be destroyed. The problem was traced to the following line of Fortran code:

```
DO 5 K = 1. 3
```

The period should have been a comma. An \$18.5 million space exploration vehicle was lost because of this typographical error.

Errors in software are not only the province of the U.S. government. An unmanned Ariane 5 rocket launched by the European Space Agency exploded on June 4, 1996, just 40 seconds after lift-off. The development cost for the rocket was \$7 billion, spanning over a decade. The rocket and its cargo were valued at \$500 million. What happened? A 64-bit floating-point number, relating to the horizontal velocity with respect to the platform, was converted to a 17-bit signed integer; the number was larger than 32,767. The resulting error caused the launcher to veer off its flight path, break up, and explode.

## 18.3 Problems

Life is full of all kinds of problems. There are problems for which it is easy to develop and implement computer solutions. There are problems for which we can implement computer solutions, but we wouldn't get

the results in our lifetime. There are problems for which we can develop and implement computer solutions, provided we have enough computer resources. There are problems for which we can prove there are no solutions. Before we can look at these categories of problems, we must introduce a way of comparing algorithms.

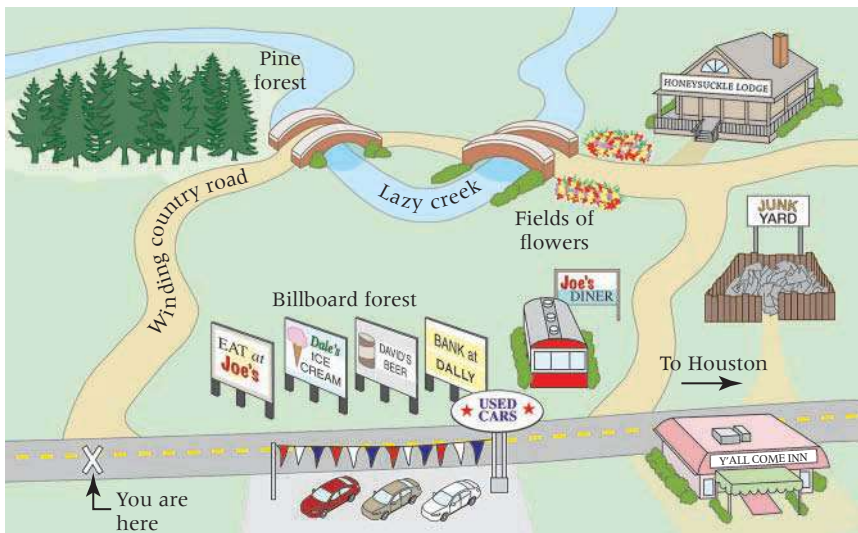
## Comparing Algorithms

As we have shown in previous chapters, there is more than one way to solve most problems. If you were asked for directions to Joe's Diner (see [FIGURE 18.2](#)), you could give either of two equally correct answers:

1. "Go east on the big highway to the Y'all Come Inn, and turn left."
- or
2. "Take the winding country road to Honeysuckle Lodge, and turn right."

The two answers are not the same, but because following either route gets the traveler to Joe's Diner, both answers are functionally correct.

If the request for directions contained special requirements, one solution might be preferable to the other. For instance, "I'm late for dinner. What's the quickest route to Joe's Diner?" calls for the first answer, whereas "Is there a scenic road that I can take to get to Joe's



**FIGURE 18.2** Equally valid solutions to the same problem



## Tag—you're it

Some textile manufacturers falsify their products' country of origin to avoid paying taxes on clothes imported into the United States. A new marking system that encodes information invisible to the naked eye could save millions of dollars annually in tax revenue lost to counterfeiters. The system marks textiles with a micro-taggant that scanners can read using near-infrared light. Scanners identify the textile's source, type, production conditions, and composition. A micro-taggant can survive the harsh manufacturing process, which may include scouring, bleaching, and dyeing steps. This technology also has potential for use in homeland defense, inventory tracking and control, and military applications.

Diner?" suggests the second. If no special requirements are known, the choice is a matter of personal preference—which road do you like better?

Often the choice between algorithms comes down to a question of efficiency. Which one takes the least amount of computing time? Which one does the job with the least amount of work? Here we are interested in the amount of work that the computer does.

To compare the work done by competing algorithms, we must first define a set of objective measures that can be applied to each algorithm. The analysis of algorithms is an important area of theoretical computer science; in advanced computing courses, students see extensive work in this area. We cover only a small part of this topic in this book—just enough to allow you to compare two algorithms that do the same task and understand that the complexity of algorithms forms a continuum from easy to unsolvable.

How do programmers measure the work that two algorithms perform? The first solution that comes to mind is simply to code the algorithms and then compare the execution times for running the two programs. The one with the shorter execution time is clearly the better algorithm. Or is it? Using this technique, we really can determine only that program A is more efficient than program B on a particular computer. Execution times are specific to a *particular computer*. Of course, we could test the algorithms on all possible computers, but we want a more general measure.

A second possibility is to count the number of instructions or statements executed. This measure, however, varies with the programming language used as well as with the style of the individual programmer. To standardize this measure somewhat, we could count the number of passes through a critical loop in the algorithm. If each iteration involves a constant amount of work, this measure gives us a meaningful yardstick of efficiency.

Another idea is to isolate a particular operation fundamental to the algorithm and then count the number of times that this operation is performed. Suppose, for example, that we are summing the elements in an integer list. To measure the amount of work required, we could count the integer addition operations. For a list of 100 elements, there are 99 addition operations. Note that we do not actually have to count the number of addition operations; it is some *function* of the number of elements ( $N$ ) in the list. Therefore, we can express the number of addition operations in terms of  $N$ : for a list of  $N$  elements, there are  $N - 1$  addition operations. Now we can compare the algorithms for the general case, not just for a specific list size.

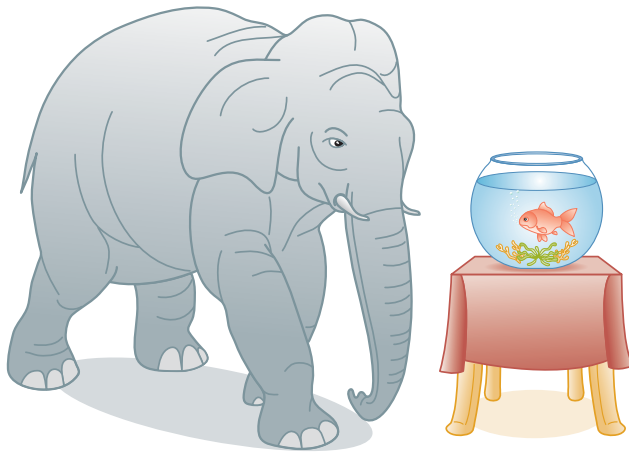
## Big-O Analysis

We have been talking about work as a function of the size of the input to the operation (for instance, the number of elements in the list to be summed). We can express an approximation of this function using a mathematical notation called *order of magnitude*, or **Big-O notation**. (This is the letter O, not a zero.) The order of magnitude of a function is identified with the term in the function that increases fastest relative to the size of the problem. For instance, if

$$f(N) = N^4 + 100N^2 + 10N + 50$$

then  $f(N)$  is of order  $N^4$ —or, in Big-O notation,  $O(N^4)$ . That is, for large values of  $N$ , some multiple of  $N^4$  dominates the function for sufficiently large values of  $N$ . It isn't that  $100N^2 + 10N + 50$  is not important, it is just that as  $N$  gets larger, all other factors become irrelevant because the  $N^4$  term dominates.

How is it that we can just drop the low-order terms? Well, suppose you needed to buy an elephant and a goldfish from one of two pet suppliers. You really need only to compare the prices of elephants, because the cost of the goldfish is trivial in comparison (see [FIGURE 18.3](#)). In analyzing algorithms, the term that increases most rapidly relative to the size of the problem dominates the function, effectively relegating the others to the “noise” level. The cost of an elephant is so much greater that we could just ignore the goldfish. Similarly, for large values of  $N$ ,  $N^4$  is so much larger than 50,  $10N$ , or even  $100N^2$  that we can ignore these other terms. This doesn't mean that the other terms do not contribute to the computing time; it simply means that they are not significant in our approximation when  $N$  is “large.”



**FIGURE 18.3** The price of a goldfish pales in comparison to the price of an elephant

### Big-O notation

A notation that expresses computing time (complexity) as the term in a function that increases most rapidly relative to the size of a problem

What is this value  $N$ ?  $N$  represents the size of the problem. Most problems involve manipulating data structures like those discussed in Chapter 8. As we already know, each structure is composed of elements. We develop algorithms to add an element to the structure and to modify or delete an element from the structure. We can describe the work done by these operations in terms of  $N$ , where  $N$  is the number of elements in the structure.

Suppose that we want to write all the elements in a list into a file. How much work does that task require? The answer depends on how many elements are in the list. Our algorithm is

Open the file  
 While (more elements)  
   Get next element  
   Write next element

If  $N$  is the number of elements in the list, the “time” required to do this task is

$$\text{time-to-open-the-file} + [N * (\text{time-to-get-one-element} + \text{time-to-write-one-element})]$$

This algorithm is  $O(N)$  because the time required to perform the task is proportional to the number of elements ( $N$ )—plus a little to open the file. How can we ignore the open time in determining the Big-O approximation? Assuming that the time necessary to open a file is constant, this part of the algorithm is our goldfish. If the list has only a few elements, the time needed to open the file may seem significant. For large values of  $N$ , however, writing the elements is an elephant in comparison with opening the file.

The order of magnitude of an algorithm does not tell us how long in microseconds the solution takes to run on our computer. Sometimes we may need that kind of information. For instance, suppose a word processor’s requirements state that the program must be able to spell-check a 50-page document (on a particular computer) in less than 120 seconds. For this kind of information, we do not use Big-O analysis; we use other measurements. We can compare different implementations of a data structure by coding them and then running a test, recording the time on the computer’s clock before and after we conduct the test. This kind of “benchmark” test tells us



### The Bletchley Circle

PBS aired a three-part murder mystery in spring 2013 in which the protagonists were the Bletchley Girls, who reunite after the war and put their code-breaking skills toward solving crimes. They returned for a second season in 2014.

© Artur Debat/Getty Images; © Alan Dyer/Stocktrek Images/Getty Images

## Family Laundry: An Analogy

How long does it take to do a family's weekly laundry? We might describe the answer to this question with the function

$$f(N) = c * N$$

where  $N$  represents the number of family members and  $c$  is the average number of minutes that each person's laundry takes. We say that this function is  $O(N)$  because the total laundry time depends on the number of people in the family. The "constant"  $c$  may vary a little for different families, depending on how big the washing machine is and how fast the family members can fold clothes, for instance. That is, the time to do the laundry for two different families might be represented with these functions:

$$\begin{aligned} f(N) &= 100 * N \\ g(N) &= 90 * N \end{aligned}$$

Overall, we describe these functions as  $O(N)$ .

Now, what happens when Grandma and Grandpa come to visit the first family for a week or two? The laundry time function becomes

$$f(N) = 100 * (N + 2)$$

We still say that the function is  $O(N)$ . How can that be? Doesn't the laundry for two extra people take any time to wash, dry, and fold? Of course it does! If  $N$  is small (the family consists of Mother, Father, and Baby), the extra laundry for two people is significant. But as  $N$  grows large (the family consists of Mother, Father, 12 kids, and a live-in babysitter), the extra laundry for two

people doesn't make much difference. (The family's laundry is the elephant; the guests' laundry is the goldfish.) When we compare algorithms using Big-O complexity, we are concerned with what happens when  $N$  is "large."

If we are asking the question, "Can we finish the laundry in time to make the 7:05 train?", we want a precise answer. The Big-O analysis doesn't give us this information; it gives us an approximation. So, if  $100 * N$ ,  $90 * N$ , and  $100 * (N + 2)$  are all  $O(N)$ , how can we say which is "better"? We can't—in Big-O terms, they are all roughly equivalent for large values of  $N$ . Can we find a better algorithm for getting the laundry done? If the family wins the state lottery, they can drop all their dirty clothes at a professional laundry 15 minutes' drive from their house (30 minutes round-trip). Now the function is

$$f(N) = 30$$

This function is  $O(1)$ . The answer does not depend on the number of people in the family. If they switch to a laundry 5 minutes from their house, the function becomes

$$f(N) = 10$$

This function is also  $O(1)$ . In Big-O terms, the two professional-laundry solutions are equivalent: No matter how many family members or house guests you have, it takes a constant amount of the family's time to do the laundry. (We aren't concerned with the professional laundry's time.)

how long the operations take on a particular computer, using a particular compiler. The Big-O analysis, by contrast, allows us to compare algorithms without reference to these factors.

### Common Orders of Magnitude

**$O(1)$  is called *bounded time*.** The amount of work is bounded by a constant and is not dependent on the size of the problem. Assigning a value to the  $i$ th element in an array of  $N$  elements is  $O(1)$ , because an element in an array can be accessed directly through its index. Although bounded time is often called *constant time*, the amount of work is not necessarily constant. It is, however, bounded by a constant.

**$O(\log_2 N)$  is called *logarithmic time*.** The amount of work depends on the log of the size of the problem. Algorithms that successively cut the amount of data to be processed in half at each step typically fall into this category. Finding a value in a list of sorted elements using the binary search algorithm is  $O(\log_2 N)$ .

**$O(N)$  is called *linear time*.** The amount of work is some constant times the size of the problem. Printing all of the elements in a list of  $N$  elements is  $O(N)$ . Searching for a particular value in a list of unsorted elements is also  $O(N)$  because you (potentially) must search every element in the list to find it.

**$O(N \log_2 N)$  is called (for lack of a better term)  *$N \log_2 N$  time*.** Algorithms of this type typically involve applying a logarithmic algorithm  $N$  times. The better sorting algorithms, such as Quicksort, Heapsort, and Mergesort, have  $N \log_2 N$  complexity. That is, these algorithms can transform an unsorted list into a sorted list in  $O(N \log_2 N)$  time, although Quicksort degenerates to  $O(N^2)$  under certain input data.

**$O(N^2)$  is called *quadratic time*.** Algorithms of this type typically involve applying a linear algorithm  $N$  times. Most simple sorting algorithms are  $O(N^2)$  algorithms.

**$O(2^N)$  is called *exponential time*.** These algorithms are costly. As you can see in [TABLE 18.2](#), exponential times increase dramatically in relation to the size of  $N$ . The fable of the King and the Corn demonstrates an exponential time algorithm, where the size of the problem is a kernel of corn. (The values in the last column of Table 18.2 grow so quickly that



#### Would you respond?

Here's another attempt at a scam email: "I am Capt James Roy. I am US Army in artillery military unit here in Iraq, we discovered some oil money in Iraq. we want you to keep it safe for us."<sup>24</sup> Would you ever fall for something like this?



TABLE

## 18.2 Comparison of rates of growth

$N$	$\log_2 N$	$N \log_2 N$	$N^2$	$N^3$	$2^N$
1	0	1	1	1	2
2	1	2	4	8	4
4	2	8	16	64	16
8	3	24	64	512	256
16	4	64	256	4096	65,536
32	5	160	1024	32,768	4,294,967,296
64	6	384	4096	262,144	About 5 years' worth of instructions on a supercomputer
128	7	896	16,384	2,097,152	About 600,000 times greater than the age of the universe in nanoseconds (for a 6-billion-year estimate)
256	8	2048	65,536	16,777,216	Don't ask!

the computation time required for problems of this order may exceed the estimated life span of the universe!)

**$O(N!)$  is called *factorial time*.** These algorithms are even more costly than exponential algorithms. The traveling salesperson graph algorithm (see page 618) is a factorial time algorithm.

Algorithms whose order of magnitude can be expressed as a polynomial in the size of the problem are called **polynomial-time algorithms**. Recall from Chapter 2 that a polynomial is a sum of two or more algebraic terms, each of which consists of a constant multiplied by one or more variables raised to a nonnegative integral power. Thus, polynomial algorithms are those whose order of magnitude can be expressed as the size of the problem to a power, and the Big-O complexity of the algorithm is the highest power in the polynomial. All polynomial-time algorithms are defined as being in **Class P**.

**Polynomial-time algorithms** Algorithms whose complexity can be expressed as a polynomial in the size of the problem

**Class P** The class made up of all polynomial-time algorithms



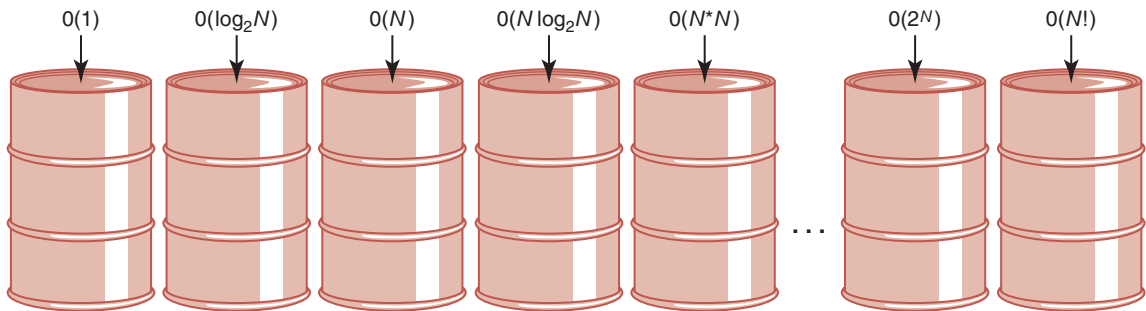


FIGURE 18.4 Orders of complexity

Think of common orders of complexity as being bins into which we sort algorithms (see FIGURE 18.4). For small values of the size of the problem, an algorithm in one bin may actually be faster than the equivalent algorithm in the next-more-efficient bin. As the size increases, the difference among algorithms in the different bins gets larger. When choosing between algorithms in the same bin, we look at the goldfish that we ignored earlier.

## Turing Machines

We have mentioned Alan Turing several times in this book. He developed the concept of a computing machine in the 1930s. He was not interested in implementing his machine; rather, he used it as a model to study the limits of what can be computed.

A *Turing machine*, as his model became known, consists of a control unit with a read/write head that can read and write symbols on an infinite tape. The tape is divided into cells. The model is based on a person doing a primitive calculation on a long strip of paper using a pencil with an eraser. Each line (cell) of the paper contains a symbol from a finite alphabet. Starting at one cell, the person examines the symbol and then either leaves the symbol alone or erases it and replaces it with another symbol from the alphabet. The person then moves to an adjacent cell and repeats the action.

The control unit simulates the person. The human's decision-making process is represented by a finite series of instructions that the control unit can execute. Each instruction causes:

- A symbol to be read from a cell on the tape
- A symbol to be written into the cell
- The tape to be moved one cell left, moved one cell right, or remain positioned as it was

© Artur Debat/Getty Images; © Alan Dyer/Stocktrek Images/Getty Images

## Alan Turing

*Time* magazine chose Alan Turing as one of its 100 most influential persons of the twentieth century. The biography of Turing read:

For what this eccentric young Cambridge don did was to dream up an imaginary machine—a fairly simple typewriter-like contraption capable somehow of scanning, or reading, instructions encoded on a tape of theoretically infinite length. As the scanner moved from one square of the tape to the next—responding to the sequential commands and modifying its mechanical response if so ordered—the output of such a process, Turing demonstrated, could replicate logical human thought.

The device in this inspired mind-experiment quickly acquired a name: the Turing machine, and so did another of Turing's insights. Since the instructions on the tape governed the behavior of the machine, by changing those instructions, one could induce the machine to perform the functions of all such machines. In other words, depending on the tape it scanned, the same machine could calculate numbers or play chess or do anything else of a comparable nature. Hence his device acquired a new and even grander name: the Universal Turing Machine.

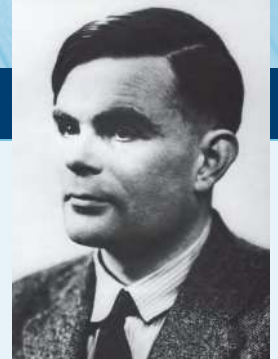
...

So many ideas and technological advances converged to create the modern computer that it is

foolhardy to give one person all the credit for inventing it. But the fact remains that everyone who taps at a keyboard, opening a spreadsheet or a word-processing program, is working on an incarnation of a Turing machine.<sup>25</sup>

Alan Turing was born in June 1912 to Julius Mathison Turing, a member of the Indian Civil Service, and Ethel Sara Stoney, daughter of the chief engineer of the Madras railway. His father and mother spent most of their time in India, while he and his older brother were in various foster homes in England until his father's retirement in 1926.

The British public (read *private* in American English) school system of the day did not foster original thinking, so Turing had trouble fitting in. He was criticized for his handwriting, struggled in English, and even in mathematics didn't produce the expected conventional answers. At Sherborne School, which he had entered at 13, the headmaster said that if he was solely a scientific specialist, he was wasting his time at a public school. Yet a public school education was terribly important to his mother, so Turing persisted. Two things sustained him during this period: his own independent study and the friendship of Christopher Morcom, who was a student a year ahead of him in school. Morcom provided vital intellectual companionship, which ended after two years with Morcom's sudden death.



© Pictorial Press Ltd/Alamy Stock Photo

© Artur Debat/Getty Images; © Alan Dyer/Stocktrek Images/Getty Images

## Alan Turing (continued)

In 1931, Turing entered King's College, Cambridge, to study mathematics. The atmosphere at King's College encouraged free-ranging thought, providing him with an intellectual home for the first time. He graduated in 1934 and was elected a fellow of King's College in 1935 for a dissertation "On the Gaussian Error Function," which proved fundamental results in probability theory.

Turing then began to work on decidability questions, based on a course he had taken on the foundations of mathematics with Max Newman. In 1936, Turing published a paper in which he introduced the concept of what we now call a *Turing machine*.

At the outbreak of World War II, Turing went to work for the British government. He was recruited into the Government Code and Cypher School, located in a Victorian mansion called Bletchley Park. He joined several others in the task of breaking the Enigma codes used in Nazi communication.<sup>26</sup>

Turing was awarded the Order of the British Empire in 1945 for his contributions to the war effort.

After a frustrating experience at the National Physical Laboratory in London, where he was to build a computer, Turing returned to Cambridge, where he continued to work and write. The wartime spirit of cooperation that had short-circuited bureaucracy had faded, and the ACE

(Automatic Computing Engine) was never built. In 1948, Turing became a Deputy Director of the computing laboratory at Manchester University. Turing spent the next years working and writing on a variety of different subjects.

In 1950, he published an article reflecting one of his major interests: Can machines think? From this article came the well-known Turing test. Turing also became interested in morphogenesis, the development of pattern and form in living organisms. All the while he continued his research in decidability and quantum theory.

In 1952 Turing was convicted of "gross indecency," a term used at that time to refer to homosexuality. He was sentenced to chemical castration by a series of injections of female hormones.

On June 7, 1954, Turing died of cyanide poisoning, a half-eaten apple laying beside his bed. His mother believed that he accidentally died while conducting an experiment; the coroner's verdict was suicide. In 2013, Queen Elizabeth II granted Alan Turing a posthumous pardon of his 1952 conviction.

The award-winning one-man play called *Breaking the Code* gives audiences a brief glimpse of Turing's brilliant, complex character. Turing's efforts as a code breaker are also presented in the 2014 feature film *The Imitation Game* starring Benedict Cumberbatch.

If we allow the person to replace a symbol with itself, these actions do, indeed, model a person with a pencil. See [FIGURE 18.5](#).

Why is such a simple machine (model) of any importance? It is widely accepted that *anything that is intuitively computable can be computed by a Turing machine*. This statement is known as the *Church–Turing thesis*, named for Turing and Alonzo Church, another mathematician who developed a similar model known as the *lambda calculus* and with whom Turing worked at Princeton. The works of Turing and Church are covered in depth in theoretical courses in computer science.

It follows from the Church–Turing thesis that if we can find a problem for which a Turing-machine solution can be proven *not* to exist, then that problem must be unsolvable. In the next section we describe such a problem.

## Halting Problem

It is not always obvious that a computation (program) halts. In Chapter 6, we introduced the concept of repeating a process; in Chapter 7, we talked about different types of loops. Some loops clearly stop, some loops clearly do not (infinite loops), and some loops stop depending on input data or calculations that occur within the loop. When a program is running, it is difficult to know whether it is caught in an infinite loop or whether it just needs more time to run.

It would be very beneficial if we could predict that a program with a specified input would not go into an infinite loop. The **halting problem** restates the question this way: *Given a program and an input to the program, determine if the program will eventually stop with this input.*

The obvious approach is to run the program with the specified input and see what happens. If it stops, the answer is clear. What if it doesn't stop? How long do you run the program before you decide that it is in an infinite loop? Clearly, this approach has some flaws. Unfortunately, there are flaws in every other approach as well. This problem is unsolvable. Let's look at the outlines of a proof of this assertion, which can be rephrased as follows: "There is no Turing-machine program that can determine whether a program will halt given a particular input."

How can we prove that a problem is unsolvable or, rather, that we just haven't found the solution yet? We could try every proposed solution and show that every one contains an error. Because there are many known solutions and many yet unknown, this approach seems doomed to failure. Yet, this approach forms the basis of Turing's solution to this



**FIGURE 18.5** Turing machine processing

**Halting problem** The unsolvable problem of determining whether any program will eventually stop given a particular input

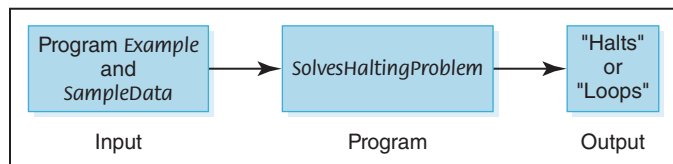
problem. In his proof, he starts with any proposed solution and then shows that it doesn't work.

Assume that there exists a Turing-machine program called *SolvesHaltingProblem* that determines for any program *Example* and input *SampleData* whether program *Example* halts given input *SampleData*. That is, *SolvesHaltingProblem* takes program *Example* and *SampleData* and prints "Halts" if the program halts and "Loops" if the program contains an infinite loop. This situation is depicted in [FIGURE 18.6](#).

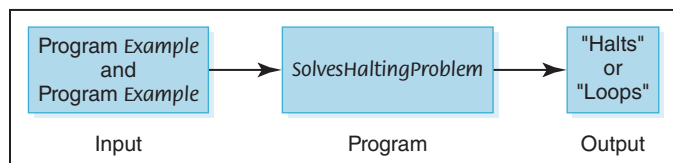
Recall that both programs (instructions) and data look alike in a computer; they are just bit patterns. What distinguishes programs from data is how the control unit interprets the bit pattern. So we could give program *Example* a copy of itself as data in place of *SampleData*. Thus *SolvesHaltingProblem* should be able to take program *Example* and a second copy of program *Example* as data and determine whether program *Example* halts with itself as data. See [FIGURE 18.7](#).

Now let's construct a new program, *NewProgram*, that takes program *Example* as both program and data and uses the algorithm from *SolvesHaltingProblem* to write "Halts" if *Example* halts and "Loops" if it does not halt. If "Halts" is written, *NewProgram* creates an infinite loop; if "Loops" is written, *NewProgram* writes "Halts." [FIGURE 18.8](#) shows this situation.

Do you see where the proof is leading? Let's now apply program *SolvesHaltingProblem* to *NewProgram*, using *NewProgram* as data. If *SolvesHaltingProblem* prints "Halts," program *NewProgram* goes into an infinite loop. If *SolvesHaltingProblem* prints "Loops," program *NewProgram* prints "Halts" and stops. In either case, *SolvesHaltingProblem* gives the wrong answer. Because



**FIGURE 18.6** Proposed program for solving the halting problem



**FIGURE 18.7** Proposed program for solving the halting problem

`SolvesHaltingProblem` gives the wrong answer in at least one case, it doesn't work on all cases. Therefore, any proposed solution must have a flaw.

## Classification of Algorithms

Figure 18.4 shows the common orders of magnitude as bins. We now know that there is another bin to the right, which would contain algorithms that are unsolvable. Let's reorganize our bins a little, combining all polynomial algorithms in a bin labeled **Class P**. Then let's combine exponential and factorial algorithms into one bin and add a bin labeled *Unsolvable*. See

FIGURE 18.9

The algorithms in the middle bin have known solutions, but they are called *intractable* because for data of any size, they simply take too long to execute. We mentioned parallel computers in Chapter 1 when we reviewed the history of computer hardware. Could some of these problems be solved in a reasonable time (polynomial time) if enough processors worked on the problem at the same time? Yes, they could.

### Class P problems

Problems that can be solved with one processor in polynomial time

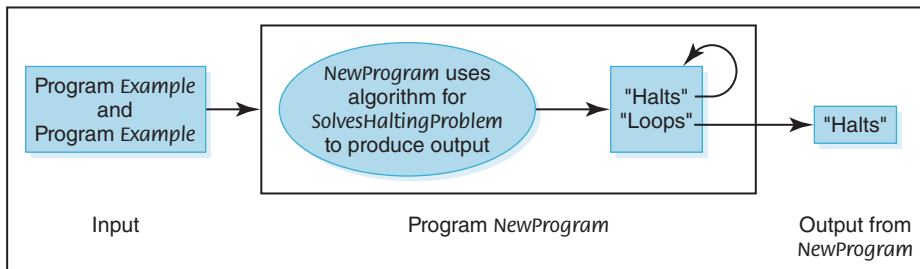


FIGURE 18.8 Construction of `NewProgram`

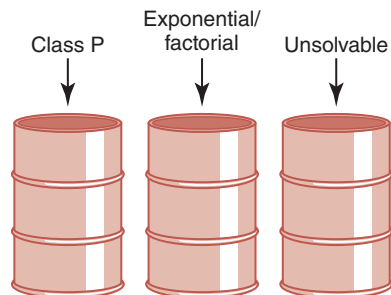


FIGURE 18.9 A reorganization of algorithm classifications

?

### The Traveling Salesman Problem

A classic NP problem is called the *Traveling Salesman Problem*. A salesman is responsible for visiting all the cities in his sales district. To visit every one in an efficient manner, he wants to find a route of minimal cost that goes through each city once and only once before returning to the starting point. The cities can be represented in a graph with the edges representing highways between cities. Each edge is labeled with the distance between the cities. The solution then becomes a well-known graph algorithm whose solution with one processor is  $O(N!)$ .

#### Class NP problems

Problems that can be solved in polynomial time with as many processors as desired

#### NP-complete problems

A class of problems within Class NP that has the property that if a polynomial time solution with one processor can be found for any member of the class, such a solution exists for every member of the class

A problem is said to be in **Class NP** if it can be solved with a sufficiently large number of processors in polynomial time.

Clearly, Class P problems are also in Class NP. An open question in theoretical computing is whether Class NP problems, whose only tractable solution is with many processors, are also in Class P. That is, do there exist polynomial-time algorithms for these problems that we just haven't discovered (invented) yet? We don't know, but the problem has been and is still keeping computer science theorists busy looking for the solution. *The* solution? Yes, the problem of determining whether Class P is equal to Class NP has been reduced to finding a solution for one of these algorithms. A special class called **NP-complete problems** is part of Class NP; these problems have the property that they can be mapped into one another. If a polynomial-time solution with one processor can be found for any one of the algorithms in this class, a solution can be found for each of them—that is, the solution can be mapped to all the others. How and why this is so is beyond the scope of this book. However, if the solution is found, you will know, because it will make headlines all over the computing world.

For now we picture our complexity bins with a new companion—a bin labeled *Class NP*. This bin and the Class P bin have dotted lines on their adjacent sides, because they may actually be just one bin. See

FIGURE 18.10

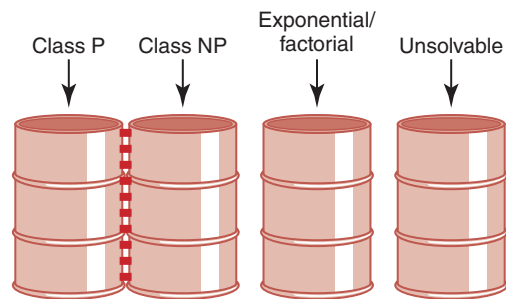
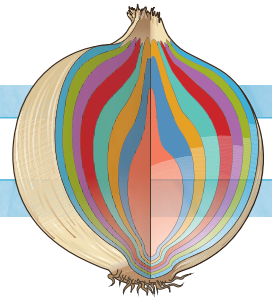


FIGURE 18.10 Adding Class NP



© Artur Debat/Getty Images, © Alan Dyer/Stocktrek Images/Getty Images

## SUMMARY



Limits are imposed on computer problem-solving by the hardware, the software, and the nature of the problems to be solved. Numbers are infinite, but their representation within a computer is finite. This limitation can cause errors to creep into arithmetic calculations, giving incorrect results. Hardware components can wear out, and information can be lost during intercomputer and intracomputer data transfers.

The sheer size and complexity of large software projects almost guarantee that errors will occur. Testing a program can demonstrate errors, but it cannot prove the absence of errors. The best way to build good software is to pay attention to quality from the first day of the project, applying the principles of software engineering.

Problems vary from those that are very simple to solve to those that cannot be solved at all. Big-O analysis provides a metric that allows us to compare algorithms in terms of the growth rate of a size factor in the algorithm. Polynomial-time algorithms are those algorithms whose Big-O complexity can be expressed as a polynomial in the size factor. Class P problems can be solved with one processor in polynomial time. Class NP problems can be solved in polynomial time with an unlimited number of processors. As proved by Turing, the halting problem does not have a solution.





## ETHICAL ISSUES

### Therac-25: Anatomy of a Disaster

Linear accelerators create high-energy beams that are used in treating tumors. There are two kinds: For relatively shallow tissue, accelerated electrons are used, and for deeper tissue, X-ray photons, converted from the electron beams, are used. The Therac-6 produced X-rays only; the Therac-20 was dual mode and produced both.

Like the Therac-20, the Therac-25 was a dual-mode machine, but it was more compact and more versatile. All three Therac machines were controlled by a PDP-11 computer. The two earlier machines were designed around stand-alone machines that had clinical histories without computer control. The computer controls were an add-on. The Therac-25 was designed to be computer controlled from the beginning. Thus there were hardware safety mechanisms in the early machines that were not in the Therac-25, which relied basically on software.

Between 1985 and 1986, six patients died from radiation overdoses after receiving treatment using the Therac-25. The cases occurred in different geographical regions, were investigated mostly in isolation, and the software was corrected each time. No accidents have been reported since 1987.

What were the causes of the problems?

- Some of the software on the Therac-25 was reused from earlier models and not adequately tested in the new environment. The earlier models had built-in hardware checks

for which the Therac-25 relied on software—the *borrowed* software.

- If an operator quickly made an input correction, both the original and the corrected instructions were sent and the one that was received first was executed. This is called a *race condition*. Error messages were given, but they were so cryptic that the operators didn't know what they meant and ignored them.
- A small internal software flag occasionally overflowed, causing an arithmetic error that bypassed safety checks.
- The Therac-25 malfunctioned in small ways very frequently. A radiation therapist reported that an average of 40 underdose malfunctions on a single day were common. The operator testified that she had been taught that there were “so many safety mechanisms” that she understood that it was virtually impossible to overdose a patient.

Leveson and Turner, in their article in *IEEE Computer*, add this scathing comment:

“A lesson to be learned from the Therac-25 story is that focusing on particular software bugs is not the way to make a safe system. Virtually all complex software can be made to behave in an unexpected fashion under certain conditions. The basic mistakes here involved poor software-engineering practices and building a machine that relies on the software for safe operation. Furthermore, the particular coding error is not as important as the general unsafe design of the software overall.”<sup>27</sup>

## KEY TERMS

Big-O notation  
Cancellation error  
Class NP problems  
Class P  
Class P problems  
Halting problem  
Inspection  
NP-complete problems  
Overflow

Polynomial-time algorithms  
Precision  
Representational (round-off) error  
Significant digits  
Software requirements  
Software specification  
Underflow  
Walk-through

## EXERCISES

For Exercises 1–15, match the Big-O notation with its definition or use.

- A.  $O(1)$
- B.  $O(\log_2 N)$
- C.  $O(N)$
- D.  $O(N \log_2 N)$
- E.  $O(N^2)$
- F.  $O(2^N)$
- G.  $O(N!)$

1. Factorial time
2.  $N \log N$  time
3. Linear time
4. Quadratic time
5. Exponential time
6. Logarithmic time
7. Bounded time
8. Time not dependent on the size of the problem

9. Algorithms that successively cut the amount of data to be processed in half at each step
10. Mergesort and Heapsort
11. Selection sort and bubble sort
12. Adding a column of  $N$  numbers
13. Demonstrated by the fable of the King and the Corn
14. Traveling salesman problem
15. What Quicksort degenerates to if the data are already sorted

For Exercises 16–20, match the name of the technique with the algorithm.

- A. Even parity
- B. Odd parity
- C. Check digits
- D. Error-correcting codes
- E. Parity bit

## EXERCISES (CONTINUED)

16. An extra bit is associated with each byte in the hardware that ensures that the number of 1 bits is odd or even across all bytes.
17. Ultimate redundancy would be to keep two copies of every value.
18. The number of 1 bits plus the parity bit is odd.
19. The number of 1 bits plus the parity bit is even.
20. A scheme to sum the individual digits in a number and store the unit's digit of that sum with the number.
21.  $(1 + x - 1)$  is always equal to  $x$ .
22. Representational error is a synonym for round-off error.
23. Software verification activities are limited to the implementation phase.
24. Half the errors in a software project occur in the design phase.
25. Most large software projects are designed by a single genius and then given to teams of programmers to implement.
26. The later in the software life cycle that an error is detected, the cheaper it is to fix.
27. Formal verification of programs is of theoretical interest but has never really been useful.
28. Big-O notation tells us how long the solution takes to run in terms of microseconds.
29. Software engineering, a branch of computing, emerged in the 1960s.
30. Maintaining and evolving existing software has become more important than building new systems.

For Exercises 21–30, mark the answers true or false as follows:

- A. True
- B. False

31. Define *representational error*, *cancellation error*, *underflow*, and *overflow*. Discuss how these terms are interrelated.
32. Show the range of integer numbers that can be represented in each of the following word sizes:
  - a. 8 bits
  - b. 16 bits
  - c. 24 bits
  - d. 32 bits
  - e. 64 bits
33. There is a logical action to take when underflow occurs, but not when overflow occurs. Explain.
34.
  - a. Show how the numbers 1066 and 1492 would be represented in a linked list with one digit per node.
  - b. Use a linked list to represent the sum of these integers.
  - c. Outline an algorithm to show how the calculation might be carried out in a computer.
35. Explain the Titanic effect in relation to hardware failure.

**EXERCISES (CONTINUED)**

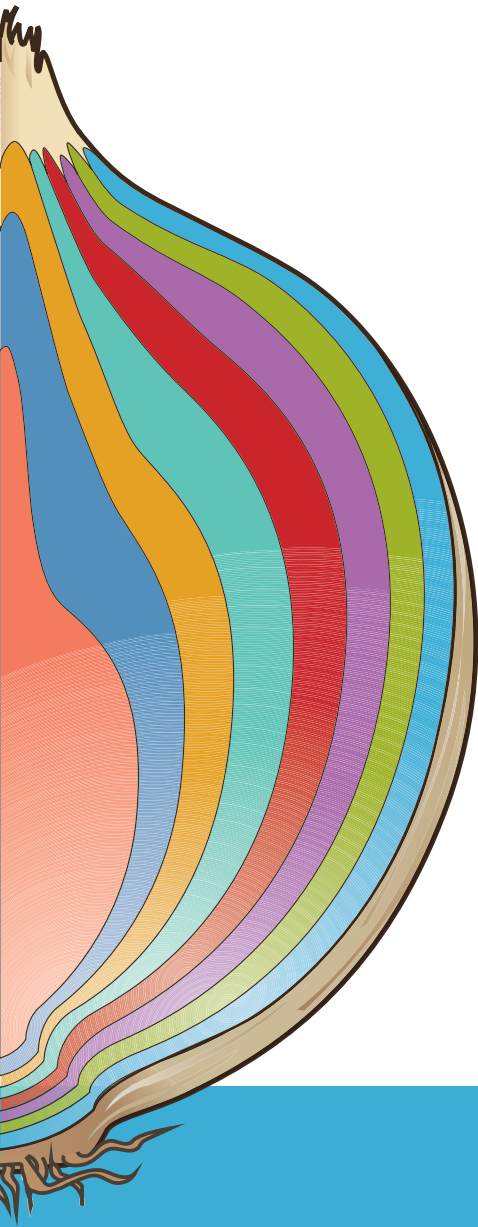
36. Have any hardware failures happened to you? Explain.
37. Given the following 8-bit code, what is the parity bit if odd parity is being used?
  - a. 11100010
  - b. 10101010
  - c. 11111111
  - d. 00000000
  - e. 11101111
38. Given the following 8-bit code, what is the parity bit if even parity is being used?
  - a. 11100010
  - b. 10101010
  - c. 11111111
  - d. 00000000
  - e. 11101111
39. Given the following numbers, what would be the check digit for each?
  - a. 1066
  - b. 1498
  - c. 1668
  - d. 2001
  - e. 4040
40. What errors would be detected using the check bits in Exercise 39?
41. Given the following numbers, what would be the additional digits if the unit's digit of the sum of the even digits were used along with the check digit?
  - a. 1066
  - b. 1498
  - c. 1668
  - d. 2001
  - e. 4040
42. Given the following numbers, what would be the additional digits if the unit's digit of the sum of the odd digits were used along with the check digit?
  - a. 1066
  - b. 1498
  - c. 1668
  - d. 2001
  - e. 4040
43. How do the representations in Exercises 41 and 42 improve the error detection over a simple check digit?
44. Explain the concept of the software life cycle.
45. Where do most of the errors occur in a software project?
46. Why does the cost of fixing an error increase the longer the error remains undetected?
47. Compare and contrast the software verification activities of code or design walk-throughs and inspections.
48. How can a program be verified to be correct but still be worthless?
49. Name at least five places where a software error could be introduced.
50. How was the AT&T software failure typical of such failures?
51. What is formal verification?
52. Explain the analogy of the elephant and the goldfish.
53. Define *polynomial time*.
54. How is it possible to throw away all but the term with the largest exponent when assessing the Big-O complexity of a polynomial-time algorithm?

**EXERCISES (CONTINUED)**

55. Give the Big-O complexity measure of the following polynomials:
  - a.  $4x^3 + 32x^2 + 2x + 1003$
  - b.  $x^5 + x$
  - c.  $x^2 + 124,578$
  - d.  $x + 1$
56. Explain the analogy of bins of complexity measures.
57. Who manufactures a Turing machine?
58. How does a Turing machine simulate a human with a paper and pencil?
59. Are there problems for which there are no solutions?
60. Describe the halting problem.
61. How is the fact that data and programs look alike inside a computer used in the proof that the halting problem is unsolvable?

**THOUGHT QUESTIONS**

1. Search the Web for information on the Pentium chip error. Try different keywords and combinations of keywords, recording how many hits occur with each. Read at least three of the articles, and then write a description of the problem in your own words.
2. Search the Web for the answers to the following questions.
  - a. Did the Russian *Phobos 1* spacecraft commit suicide?
  - b. What caused the delay in the opening of the Denver airport?
  - c. What was the cost of the software repair in London's ambulance dispatch system failure?
  - d. The USS *Yorktown* was dead in the water for several hours in 1998. What software error caused the problem?
3. A professor was giving a lecture to a local service club about the limits of computing. A member of the audience said, "But I didn't think there were any limits." If you were the professor, how would you have answered?



## GLOSSARY

**Absolute path** A path that begins at the root and includes all successive subdirectories

**Abstract data type (ADT)** A container whose properties (data and operations) are specified independently of any particular implementation

**Abstract step** An algorithmic step for which some details remain unspecified

**Abstraction** A model of a complex system that includes only the details essential to the viewer

**Access control policy** A set of rules established by an organization that specify which types of network communication are permitted and denied

**Access time** The time it takes for a block to start being read; the sum of seek time and latency

**Adder** An electronic circuit that performs an addition operation on binary values

**Addressability** The number of bits stored in each addressable location in memory

**Address binding** The mapping from a logical address to a physical address

**Adjacent vertices** Two vertices that are connected by an edge

## Glossary

**Aggregate operation** An operation on a data structure as a whole, as opposed to an operation on an individual component of the data structure

**Algorithm** Unambiguous instructions for solving a problem or subproblem in a finite amount of time using a finite amount of data

**ALU** See *arithmetic/logic unit*

**Analog data** A continuous representation of data

**Antivirus software** Software designed to detect, remove, and/or prevent malicious software

**Application software** Programs that help us solve real-world problems

**Arguments** The identifiers listed in parentheses on the subprogram call; sometimes called *actual parameters*

**Arithmetic/logic unit (ALU)** The computer component that performs arithmetic operations (addition, subtraction, multiplication, division) and logical operations (comparison of two values)

**Artificial intelligence (AI)** The study of computer systems that model and apply the intelligence of the human mind

**Artificial neural network** A computer representation of knowledge that attempts to mimic the neural networks of the human body

**Assembler** A program that translates an assembly-language program into machine code

**Assembler directives** Instructions to the translating program

**Assembly language** A low-level programming language in which a mnemonic represents each of the machine-language instructions for a particular computer

**Assignment statement** A statement that stores the value of an expression into a variable

**Asynchronous** Not occurring at the same moment in time as some specific operation of the computer; in other words, not synchronized with the program's actions

**Attribute** Part of a tag that provides additional information about the element

**Authentication credentials** Information users provide to identify themselves

**Availability** The degree to which authorized users can access information for legitimate purposes

**Back door** A program feature that gives special and unauthorized access to a software system to anyone who knows it exists

**Bandwidth** The number of bits or bytes that can be transmitted from one place to another in a fixed amount of time

**Base** The foundational value of a number system, which dictates the number of digits and the value of digit positions

**Base register** A register that holds the beginning address of the current partition

**Big-O notation** A notation that expresses computing time (complexity) as the term in a function that increases most rapidly relative to the size of a problem

**Big data** Large data sets that defy conventional management solutions, such as spreadsheets and databases

**Binary digit** A digit in the binary number system; a 0 or a 1

**Binary file** A file that contains data in a specific format, requiring a special interpretation of its bits

**Binary search** Looking for an item in an already sorted list by eliminating large portions of the data on each comparison

**Binary tree** An abstract composite structure with a unique starting node called the *root*, in which each node is capable of having two child nodes and in which a unique path exists from the root to every other node

**Biometrics** Using physiological characteristics, such as fingerprints, to identify users and control access



## Glossary

**Bit** Binary digit

**Block** The information stored in a sector

**Blockchain** An incorruptible public ledger of transactions

**Bluetooth** A technology used for wireless communication over short distances

**Boolean algebra** A mathematical notation for expressing two-valued logical functions

**Boolean expression** A sequence of identifiers, separated by compatible operators, that evaluates to either true or false

**Bounds register** A register that holds the length of the current partition

**Branch** An instruction that indicates which instruction to process next

**Breadth-first approach** Searching across levels of a tree prior to searching down specific paths

**Broadband** Network technologies that generally provide data transfer speeds greater than 256 Kbps

**Buffer overflow** A defect in a computer program that could cause a system to crash and leave the user with heightened privileges

**Bus topology** A LAN configuration in which all nodes share a common line

**Bus width** The number of bits that can be transferred in parallel over the bus

**Byte** Eight binary digits

**Bytecode** A standard machine language into which Java source code is compiled

**Cable modem** A device that allows computer network communication using the cable TV hookup in a home

**Cache memory** A type of small, high-speed memory used to hold frequently used data

**Caesar cipher** A substitution cipher that shifts characters a certain number of positions in the alphabet

**Cancellation error** A loss of accuracy during addition or subtraction of numbers of widely differing sizes, due to limits of precision

**CAPTCHA** A software mechanism used to verify that a web form is submitted by a human and not an automated program

**Cardinality constraint** The number of relationships that may exist at one time among entities in an ER diagram

**Case sensitive** Uppercase and lowercase letters are not considered the same; two identifiers with the same spelling but different capitalization are considered to be two distinct identifiers

**Cell** An element of a spreadsheet that can contain data or a formula

**Character set** A list of the characters and the codes used to represent each one

**Chatbot** A program designed to carry on a conversation with a human user

**Cipher** An algorithm used to encrypt and decrypt text

**Circuit** A combination of interacting gates designed to accomplish a specific logical function

**Circuit equivalence** The same output for each corresponding input-value combination for two circuits

**Circular reference** A set of formulas that ultimately, and erroneously, rely on each other to compute their results

**Class (implementation phase)** A pattern for an object

**Class NP problems** Problems that can be solved in polynomial time with as many processors as desired

**Class P** The class made up of all polynomial-time algorithms

**Class P problems** Problems that can be solved with one processor in polynomial time

## Glossary

**Client/server model** A distributed approach in which a client makes requests of a server and the server responds

**Cloud computing** A paradigm in which computing system resources are provided by a third party and managed through Internet communication

**Code-coverage (clear-box) testing** Testing a program or subprogram based on covering all the statements in the code

**Combinational circuit** A circuit whose output is solely determined by its input values

**Comment** Explanatory text for the human reader

**Compiler** A program that translates a high-level language program into machine code

**Compression ratio** The size of the compressed data divided by the size of the uncompressed data

**Computational biology** An interdisciplinary field that applies techniques of computer science, applied mathematics, and statistics to problems in biology

**Computer gaming** A computer simulation of a virtual world

**Computer hardware** The physical elements of a computing system

**Computer network** A collection of computing devices connected so that they can communicate and share resources

**Computer software** The programs that provide the instructions that a computer executes

**Computing system** Computer hardware, software, and data, which interact to solve problems

**Concrete step** A step for which the details are fully specified

**Confidentiality** Ensuring that data is protected from unauthorized access

**Constant time** An algorithm whose Big-O work expression is a constant

- Containers** Objects whose role is to hold and manipulate other objects
- Context switch** The exchange of register information that occurs when one process is removed from the CPU and another takes its place
- Control abstraction** The separation of the logical view of a control structure from its implementation
- Control structure** An instruction that determines the order in which other instructions in a program are executed
- Control unit** The computer component that controls the actions of the other components so as to execute instructions in sequence
- CPU** The central processing unit, a combination of the arithmetic/logic unit and the control unit; the “brain” of a computer, which interprets and executes instructions
- CPU scheduling** The act of determining which process in memory is given access to the CPU so that it may execute
- Cryptanalysis** The process of decrypting a message without knowing the cipher or key used to encrypt it
- Cryptography** The field of study related to encoded information
- Cylinder** The set of concentric tracks on all surfaces
- Data** Basic values or facts
- Data abstraction** The separation of the logical view of data from its implementation
- Data compression** Reducing the amount of space needed to store a piece of data
- Data coverage (black-box) testing** Testing a program or subprogram based on the possible input values; treating the code as a black box
- Data structure** The implementation of a composite data field in an abstract data type
- Data transfer rate (bandwidth)** The speed with which data is moved from one place to another on a network

## Glossary

**Data type** A description of the set of values and the basic set of operations that can be applied to values of the type

**Database** A structured set of data

**Database management system** A combination of software and data made up of the physical database, the database engine, and the database schema

**Declaration** A statement that associates an identifier with a variable, an action, or some other entity within the language that can be given a name so that the programmer can refer to that item by name

**Decryption** The process of converting ciphertext into plaintext

**Demand paging** An extension to paged memory management in which pages are brought into memory only when referenced (on demand)

**Denial of service** An attack on a network resource that prevents authorized users from accessing the system

**Depth-first approach** Searching down the paths of a tree prior to searching across levels

**Desk checking** Tracing the execution of a design on paper

**Digital certificate** A representation of a sender's authenticated public key used to minimize malicious forgeries

**Digital data** A discrete representation of data

**Digital signature** Data that is appended to a message, made from the message itself and the sender's private key, to ensure the authenticity of the message

**Digital subscriber line (DSL)** An Internet connection made using a digital signal on regular phone lines

**Digitize** The act of breaking information down into discrete pieces

**Direct file access** The technique in which data in a file is accessed directly, by specifying logical record numbers

**Directed graph (digraph)** A graph in which each edge is directed from one vertex to another (or the same) vertex

**Directory** A named group of files

**Directory tree** A structure showing the nested directory organization of the file system

**Disk scheduling** The act of deciding which outstanding requests for disk I/O to satisfy first

**Document Type Definition (DTD)** A specification of the organization of an XML document

**Domain name** The part of a hostname that specifies an organization or group

**Domain name server** A computer that attempts to translate a hostname into an IP address

**Domain name system** A distributed system for managing hostname resolution

**Domain squatting** Purchasing a domain name with the sole intent of selling it at a high price to a person or organization that actually wants to use it

**Download** Receiving data on a local computer from the Internet

**Dumb terminal** A monitor and keyboard that allowed the user to access the mainframe computer in early timesharing systems

**Dynamic-partition technique** The memory management technique in which memory is divided into partitions as needed to accommodate programs

**Edge (arc)** A pair of vertices representing a connection between two nodes in a graph

**Effective weight** In an artificial neuron, the sum of the weights multiplied by the corresponding input values

**Electronic commerce** The process of buying and selling products and services using the World Wide Web

**Encapsulation** A language feature that enforces information hiding; bundling data and actions so that the logical properties of data and actions are separated from the implementation details

## Glossary

**Encryption** The process of converting plaintext into ciphertext

**Entity–relationship (ER) modeling** A popular technique for designing relational databases

**ER diagram** A graphical representation of an ER model

**Ethernet** A network communication protocol that is integrated into most personal computers

**Expert system** A software system based on the knowledge of human experts

**Extensible Markup Language (XML)** A language that allows the user to describe the content of a document

**Extensible Stylesheet Language (XSL)** A language for defining transformations from XML documents to other output formats

**Field (or attribute)** A single value in a database record

**Fields** Named items in a class; can be data or subprograms

**File** A named collection of data, used for organizing secondary memory

**File extension** Part of a file name that indicates the file type

**File server** A computer dedicated to storing and managing files for network users

**File system** The operating system’s logical view of the files it manages

**File type** The specific kind of information contained in a file, such as a Java program or a Microsoft Word document

**Fingerprint analysis** A technique used for user authentication that compares a scanned fingerprint to a stored copy of the authorized user’s fingerprint

**Firewall** A gateway machine and software that protects a network by filtering the traffic it allows

**Fixed-partition technique** The memory management technique in which memory is divided into a specific number of partitions into which programs are loaded

**Floating point** A representation of a real number that keeps track of the sign, mantissa, and exponent

**Frame** A fixed-size portion of main memory that holds a process page

**Full adder** A circuit that computes the sum of two bits, taking an input carry bit into account

**Game engine** A software system within which computer games are created

**Gameplay** The type of interactions and experiences a player has during the game

**Gate** A device that performs a basic operation on electrical signals, accepting one or more input signals and producing a single output signal

**Gateway** A node that handles communication between its LAN and other networks

**GPS (Global Positioning System)** A system that uses satellites to pinpoint the location of any GPS receiver

**Graph** A data structure that consists of a set of nodes and a set of edges that relate the nodes to each other

**Half adder** A circuit that computes the sum of two bits and produces the appropriate carry bit

**Halting problem** The unsolvable problem of determining whether any program will eventually stop given a particular input

**Host number** The part of an IP address that specifies a particular host on the network

**Hostname** A name made up of words separated by dots that uniquely identifies a computer on the Internet; each hostname corresponds to a particular IP address

**HTML5** The newest HTML standard with a streamlined tag system and support for dynamic content

**Huffman encoding** Using a variable-length binary string to represent a character so that frequently used characters have short codes



## Glossary

**Hypertext Markup Language (HTML)** The language used to create or build a web page

**ICANN** The international organization that approves top-level domain names

**Inference engine** The software that processes rules to draw conclusions

**Information** Data that has been organized or processed in a useful manner

**Information hiding** The practice of hiding the details of a module with the goal of controlling access to the details of the module

**Information security** The techniques and policies used to ensure proper access to data

**Information system** Software that helps the user organize and analyze data

**Inheritance** A mechanism by which one class acquires the properties—data fields and methods—of another class

**Input unit** A device that accepts data to be stored in memory

**Inspection** A verification method in which one member of a team reads the program or design aloud line by line and the others point out errors

**Instant messaging** A technique for sending short messages in real time

**Instantiate** To create an object from a class

**Instruction register (IR)** The register that contains the instruction currently being executed

**Integer** A natural number, a negative of a natural number, or zero

**Integrated circuit (chip)** A piece of silicon on which multiple gates have been embedded

**Integrity** Ensuring that data can be modified only by appropriate mechanisms

**Interactive system** A system that allows direct communication between the user and the computer

**Internet** A wide-area network that spans the planet

**Internet backbone** A set of high-speed networks carrying Internet traffic

**Internet Protocol (IP)** The network protocol that deals with the routing of packets through interconnected networks to the final destination

**Internet service provider (ISP)** An organization providing access to the Internet

**Interoperability** The ability of software and hardware on multiple machines and from multiple commercial vendors to communicate

**Interpreter** A program that inputs a program in a high-level language and directs the computer to perform the actions specified in each statement

**IP address** An address made up of four numeric values separated by dots that uniquely identifies a computer on the Internet

**Java applet** A Java program designed to be embedded into an HTML document, transferred over the Web, and executed in a browser

**JSP scriptlet** A portion of code embedded in an HTML document designed to dynamically contribute to the content of the web page

**Key** One or more fields of a database record that uniquely identifies it among all other records in the table

**Keyword encoding** Replacing a frequently used word with a single character

**Knowledge-based system** Software that uses a specific set of information

**Label** A name given to a memory location, which can then be used as an operand

**Latency** The time it takes for the specified sector to be in position under the read/write head

## Glossary

**Leaf node** A tree node that has no children

**Lexical ambiguity** The ambiguity created when words have multiple meanings

**Link** A connection between one web page and another

**Linked list** A list in which the order of the components is determined by an explicit link field in each node, rather than by the sequential order of the components in memory

**Linked structure** An implementation of a container where the items are stored together with information on where the next item can be found

**Loader** A piece of software that takes a machine-language program and places it into memory

**Local-area network (LAN)** A network connecting a small number of nodes in a close geographic area

**Loebner prize** The first formal instantiation of the Turing test, held annually

**Logic bomb** A malicious program that is set up to execute when a specific system event occurs

**Logic diagram** A graphical representation of a circuit; each type of gate has its own symbol

**Logical address** A reference to a stored value relative to the program making the reference

**Lossless compression** A data compression technique in which there is no loss of information

**Lossy compression** A data compression technique in which there is loss of information

**Machine language** The language made up of binary-coded instructions that is used directly by the computer

**Mainframe** A large, multi-user computer often associated with early timesharing systems

**Malicious code** A computer program that attempts to bypass appropriate authorization safeguards and/or perform unauthorized functions

**Man-in-the-middle** A security attack in which network communication is intercepted in an attempt to obtain key data

**Markup language** A language that uses tags to annotate the information in a document

**Memory management** The act of keeping track of how and where programs are loaded in main memory

**Metadata** Data about data

**Metalinguage** A language that is used to define other languages

**Method** A named algorithm that defines one aspect of the behavior of a class

**Metropolitan-area network (MAN)** A network infrastructure developed for a large city

**MIME type** A standard for defining the format of files that are included as email attachments or on websites

**Model** An abstraction of a real system; a representation of objects within a system and the rules that govern the behavior of the objects

**Motherboard** The main circuit board of a personal computer

**Multimedia** Several different media types

**Multiplexer** A circuit that uses a few input control signals to determine which of several input data lines is routed to its output

**Multiprogramming** The technique of keeping multiple programs in main memory at the same time, competing for the CPU

**Natural language** Languages that humans use to communicate, such as English

**Natural-language comprehension** Using a computer to apply a meaningful interpretation to human communication

## Glossary

**Natural number** The number 0 and any number obtained by repeatedly adding 1 to it

**Negative number** A value less than 0, with a sign opposite to its positive counterpart

**Nested structure (nested logic)** A structure in which one control structure is embedded within another

**Network address** The part of an IP address that specifies a network

**Network neutrality** The principle that ISPs should deliver data to everyone equally, as fast as the technology allows

**Node (host)** Any addressable device attached to a network

**Nonpreemptive scheduling** CPU scheduling that occurs when the currently executing process gives up the CPU voluntarily

**NP-complete problems** A class of problems within Class NP that has the property that if a polynomial time solution with one processor can be found for any member of the class, such a solution exists for every member of the class

**Number** A unit of an abstract mathematical system subject to the laws of arithmetic

**Object** An entity or thing that is relevant in the context of a problem

**Object (implementation phase)** An instance of a class

**Object class (class) (problem-solving phase)** A description of a group of objects with similar properties and behaviors

**Open system** A system that is based on a common model of network architecture and an accompanying suite of protocols

**Open Systems Interconnection (OSI) Reference Model** A seven-layer logical breakdown of network interaction to facilitate communication standards

**Operating system** System software that manages computer resources and provides an interface for system interaction

**Output unit** A device that prints or otherwise displays data stored in memory or makes a permanent copy of information stored in memory or another device

**Overflow** The condition that occurs when the results of a calculation are too large to represent in a given machine

**P2P model** A decentralized approach that shares resources and responsibilities among many “peer” computers

**Packet** A unit of data sent across a network

**Packet switching** The approach to network communication in which packets are individually routed to their destination, then reassembled

**Page** A fixed-size portion of a process that is stored into a memory frame

**Page-map table (PMT)** The table used by the operating system to keep track of page/frame relationships

**Page swap** Bringing in one page from secondary memory, possibly causing another to be removed

**Paged memory technique** A memory management technique in which processes are divided into fixed-size pages and stored in memory frames when loaded

**Parameter list** A mechanism for communicating between two parts of a program

**Parameters** The identifiers listed in parentheses beside the subprogram name; sometimes called *formal parameters*

**Password criteria** A set of rules that must be followed when creating a password

**Password guessing** An attempt to gain access to a computer system by methodically trying to determine a user’s password

**Password management software** A program that helps you manage sensitive data, such as passwords, in a secure manner

## Glossary

**Path** A text designation of the location of a file or subdirectory in a file system

**Phishing** Using a web page to masquerade as part of a trusted system to trick users into revealing security information

**Phone modem** A device that converts computer data into an analog audio signal and back again

**Phonemes** The set of fundamental sounds made in any given natural language

**Physical address** An actual address in the main memory device

**Ping** A program used to test whether a particular network computer is active and reachable

**Pipelining** A technique that breaks an instruction into smaller steps that can be overlapped

**Pixels** Individual dots used to represent a picture; stands for *picture elements*

**Polymorphism** The ability of a language to determine at runtime which of several possible methods will be executed for a given invocation

**Polynomial-time algorithms** Algorithms whose complexity can be expressed as a polynomial in the size of the problem

**Port** A numeric designation corresponding to a particular high-level protocol

**Positional notation** A system of expressing numbers in which the digits are arranged in succession, the position of each digit has a place value, and the number is equal to the sum of the products of each digit by its place value

**Precision** The maximum number of significant digits that can be represented

**Preemptive scheduling** CPU scheduling that occurs when the operating system decides to favor another process, preempting the currently executing process

**Procedural abstraction** The separation of the logical view of an action from its implementation

**Process** The dynamic representation of a program during execution

**Process control block (PCB)** The data structure used by the operating system to manage information about a process

**Process management** The act of keeping track of information for active processes

**Process states** The conceptual stages through which a process moves as it is managed by the operating system

**Program** A sequence of instructions written to perform a specified task

**Program counter (PC)** The register that contains the address of the next instruction to be executed

**Proprietary system** A system that uses technologies kept private by a particular commercial vendor

**Protocol** A set of rules that defines how data is formatted and processed on a network

**Protocol stack** Layers of protocols that build and rely on each other

**Pseudocode** A language designed to express algorithms

**Public-key cryptography** An approach to cryptography in which each user has two related keys, one public and one private

**Pulse-code modulation** Variation in a signal that jumps sharply between two extremes

**Query** A request to retrieve data from a database

**Radix point** The dot that separates the whole part from the fractional part in a real number in any base

**Range** A set of contiguous cells specified by the endpoints

**Raster-graphics format** Storing image information pixel by pixel



## Glossary

**Rational number** An integer or the quotient of two integers (division by zero excluded)

**Real-time system** A system in which response time is crucial given the nature of the application domain

**Reclock** The act of reasserting an original digital signal before too much degradation occurs

**Record (or object, or entity)** A collection of related fields that make up a single database entry

**Recursion** The ability of an algorithm to call itself

**Reference parameter** A parameter that expects the address of its argument to be passed by the calling unit (put on the message board)

**Referential ambiguity** The ambiguity created when pronouns could be applied to multiple objects

**Register** A small storage area in the CPU used to store intermediate values or special data

**Relational model** A database model in which data and the relationships among them are organized into tables

**Relative path** A path that begins at the current working directory

**Repeater** A network device that strengthens and propagates a signal along a long communication line

**Representational (round-off) error** An arithmetic error caused by the fact that the precision of the result of an arithmetic operation is greater than the precision of our machine

**Reserved word** A word in a language that has special meaning; it cannot be used as an identifier

**Resolution** The number of pixels used to represent a picture

**Response time** The time delay between receiving a stimulus and producing a response

**Ring topology** A LAN configuration in which all nodes are connected in a closed loop

**Risk analysis** Determining the nature and likelihood of the risks to key data

**Root** The unique starting node in a tree

**Root directory** The topmost directory, in which all others are contained

**Route cipher** A transposition cipher that lays out a message in a grid and traverses it in a particular way

**Router** A network device that directs a packet between networks toward its final destination

**Rule-based system** A software system based on a set of *if-then* rules

**Run-length encoding** Replacing a long series of repeated characters with a count of the repetition

**Schema** A specification of the logical structure of data in a database

**Scientific notation** An alternative floating-point representation

**Search tree** A structure that represents alternatives in adversarial situations, such as game playing

**Sector** A section of a track

**Security policy** A written statement describing the constraints or behavior an organization embraces regarding the information provided by its users

**Seek time** The time it takes for the read/write head to get positioned over the specified track

**Semantic network** A knowledge representation technique that represents the relationships among objects

**Semiconductor** Material such as silicon that is neither a good conductor nor a good insulator

**Sequential circuit** A circuit whose output is a function of its input values and the current state of the circuit

**Sequential file access** The technique in which data in a file is accessed in a linear fashion

## Glossary

**Shared memory parallel processor** The situation in which multiple processors share a global memory

**Signed-magnitude representation** Number representation in which the sign represents the ordering of the number (negative and positive) and the value represents the magnitude

**Significant digits** Those digits that begin with the first nonzero digit on the left and end with the last nonzero digit on the right (or a zero digit that is exact)

**Simulation** Developing a model of a complex system and experimenting with the model to observe the results

**Single contiguous memory management** The approach to memory management in which a program is loaded into one continuous area of memory

**Smart card** A card with an embedded memory chip used to identify users and control access

**Social network** An online service that allows people with shared interests to communicate and interact

**Software requirements** A statement of what is to be provided by a computer system or software product

**Software specification** A detailed description of the function, inputs, processing, outputs, and special features of a software product; it provides the information needed to design and implement the software

**Spatial compression** Movie compression technique based on the same compression techniques used for still images

**Spoofing** An attack on a computer system in which a malicious user masquerades as an authorized user

**Spreadsheet** A program that allows the user to organize and analyze data using a grid of cells

**Spreadsheet function** A computation provided by the spreadsheet software that can be incorporated into formulas

**Star topology** A LAN configuration in which a central node controls all message traffic

**Strong equivalence** The equality of two systems based on their results and the process by which they arrive at those results

**Strong typing** Each variable is assigned a type and only values of that type can be stored in the variable

**Structured Query Language (SQL)** A comprehensive relational database language for data management and queries

**Substitution cipher** A cipher that substitutes one character with another

**Synchronous processing** Multiple processors apply the same program in lockstep to multiple data sets

**Syntactic ambiguity** The ambiguity created when sentences can be constructed in various ways

**System software** Programs that manage a computer system and interact with hardware

**Table** A collection of database records

**Tag** The syntactic element in a markup language that indicates how information should be displayed

**TCP/IP** A suite of protocols and programs that support low-level network communication

**Temporal compression** Movie compression technique based on differences between consecutive frames

**Ten's complement** A representation of negative numbers, such that the negative of  $I$  is  $10$  raised to  $k$  minus  $I$

**Test plan** A document that specifies how a program is to be tested

**Test plan implementation** Using the test cases specified in a test plan to verify that a program outputs the predicted results

**Text file** A file that contains characters

## Glossary

**Thrashing** Inefficient processing caused by constant page swapping

**Time slice** The amount of time given to each process in the round-robin CPU scheduling algorithm

**Timesharing** A system in which CPU time is shared among multiple interactive users at the same time

**Top-level domain (TLD)** The last section of a domain name, specifying the type of organization or its country of origin

**Traceroute** A program that shows the route a packet takes across the Internet

**Track** A concentric circle on the surface of a disk

**Training** The process of adjusting the weights and threshold values in a neural net to get a desired outcome

**Transfer rate** The rate at which data moves from the disk to memory

**Transistor** A device that acts either as a wire or a resistor, depending on the voltage level of an input signal

**Transmission Control Protocol (TCP)** The network protocol that breaks messages into packets, reassembles them at the destination, and takes care of errors

**Transposition cipher** A cipher that rearranges the order of characters in a message

**Trojan horse** A malicious program disguised as a benevolent resource

**Truth table** A table showing all possible input values and the associated output values

**Turing test** A behavioral approach to determining whether a computer system is intelligent

**Turnaround time** The CPU scheduling metric that measures the elapsed time between a process's arrival in the ready state and its ultimate completion

**Underflow** The condition that occurs when the results of a calculation are too small to represent in a given machine

**Undirected graph** A graph in which the edges have no direction

**Uniform Resource Locator (URL)** A standard way of specifying the location of a web page

**Upload** Sending data from a local computer to a destination on the Internet

**User authentication** The process of verifying the credentials of a particular user of a computer or software system

**User Datagram Protocol (UDP)** An alternative to TCP that achieves higher transmission speeds at the cost of reliability

**Value parameter** A parameter that expects a copy of its argument to be passed by the calling unit (put on the message board)

**Variable** A location in memory, referenced by an identifier, that contains a data value

**Vector graphics** Representation of an image in terms of lines and shapes

**Vertex** A node in a graph

**Video codec** Methods used to shrink the size of a movie

**Virtual computer (machine)** A hypothetical machine designed to illustrate important features of a real machine

**Virtual machine** The illusion created by a timesharing system that each user has a dedicated machine

**Virtual memory** The illusion that there is no restriction on program size because an entire process need not be in memory at the same time

**Virus** A malicious, self-replicating program that embeds itself into other code

**Voice recognition** Using a computer to recognize the words spoken by a human

**Voice synthesis** Using a computer to create the sound of human speech

## Glossary

**Voiceprint** The plot of frequency changes over time representing the sound of human speech

**Walk-through** A verification method in which a team performs a manual simulation of the program or design

**Weak equivalence** The equality of two systems based on their results

**Web analytics** The collection and analysis of data related to website usage

**Web browser** A software tool that retrieves and displays web pages

**Web page** A document that contains or references various kinds of data

**Web server** A computer set up to respond to requests for web pages

**Website** A collection of related web pages, usually designed and controlled by the same person or company

**What-if analysis** Modifying spreadsheet values that represent assumptions to see how changes in those assumptions affect related data

**Wide-area network (WAN)** A network connecting two or more local-area networks

**Wiki** A website whose content can be created and edited by multiple users

**Wireless** A network connection made without physical wires

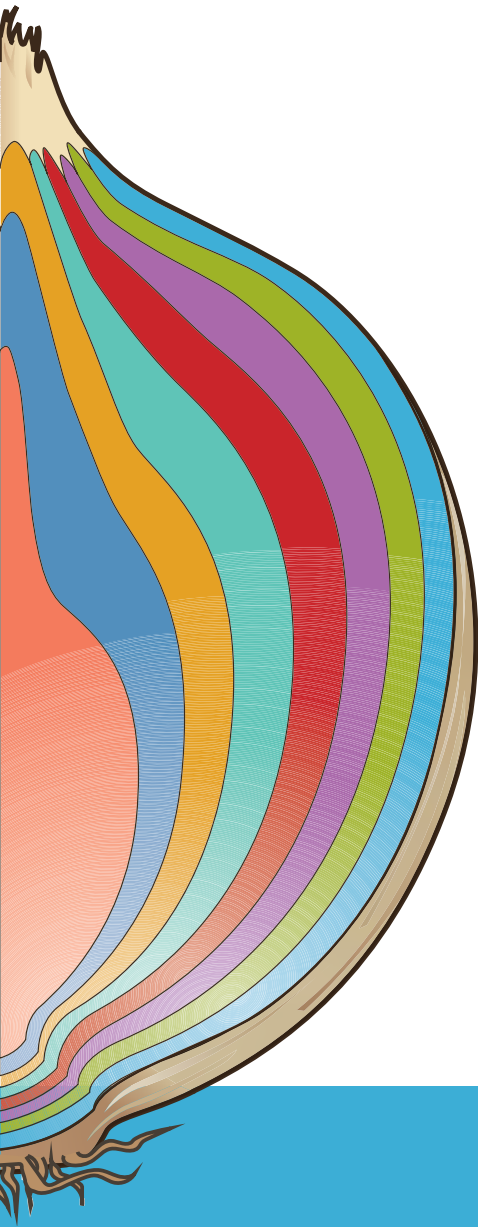
**Wireless network** A network in which devices communicate with other nodes through a wireless access point

**Word** A group of one or more bytes; the number of bits in a word is the word length of the computer

**Working directory** The currently active subdirectory

**World Wide Web (the Web)** An infrastructure of information and the network software used to access it

**Worm** A malicious stand-alone program that often targets network resources



## ENDNOTES

### Chapter 1

1. G. A. Miller, "Reprint of the Magical Number Seven Plus or Minus Two: Some Limits on Our Capacity for Processing Information," *Psychological Review* 101, no. 2 (1994): 343–352.
2. "Beyond All Dreams," <http://www.mith.umd.edu/flare/lovelace/index.html>.
3. *National Geographic News*, May 29, 2008.
4. [http://en.wikipedia.org/wiki/Timeline\\_of\\_computing\\_hardware\\_2400\\_BC%E2%80%931949](http://en.wikipedia.org/wiki/Timeline_of_computing_hardware_2400_BC%E2%80%931949) (accessed 2/11/2014).
5. P. E. Grogono and S. H. Nelson, *Problem Solving and Computer Programming* (Reading, MA: Addison-Wesley, 1982): 92.
6. D. Schmandt-Berrera, "Signs of Life," *Odyssey*, January/February 2002: 6, 7, 63.
7. Written by C. Weems, adapted from: N. Dale, C. Weems, and M. Headington, *Java and Software Design* (Sudbury, MA: Jones and Bartlett Publishers, 2001): 3523.
8. P. E. Cerruzzi, *A History of Modern Computing* (Cambridge, MA: The MIT Press, 1998): 217.
9. "Scientists Build First Nanotube Computer," *The Wall Street Journal*, September 25, 2013.
10. R. X. Gringely, "Be Absolute for Death: Life After Moore's Law," *Communications of the ACM* 44, no. 3 (2001): 94.
11. <http://mlgnn.com/?tag=steve-jobs> (accessed 9/14/2009).
12. P. E. Cerruzzi, *A History of Modern Computing* (Cambridge, MA: The MIT Press, 1998): 291.
13. <http://www.computerhistory.org> (accessed 2/12/2014).



## Endnotes

14. "Newsmakers: Schools for the World," *Parade*, April 5, 2009.
15. <http://www.roomtoread.org/page.aspx?pid=212> (accessed 2/21/2014).
16. S. Levy, "Back to the Future," *Newsweek*, April 21, 2003.
17. L. Kappelman, "The Future Is Ours," *Communications of the ACM* 44, no. 3 (2001): 46.
18. <http://wilk4.com/humor/humore10.htm> (accessed 4/10/2009).
19. <http://digg.com/d1LmM> (accessed 4/13/2009).
20. P. Denning, "Computer Science the Discipline," *Encyclopedia of Computer Science*, ed. E. Reilly, A. Ralston, and D. Hemmendinger (Groves Dictionaries, Inc., 2000).
21. Andrew Tannenbaum. Keynote address at the Technical Symposium of the Special Interest Group on Computer Science Education, San Jose, California, February 1997.
22. <https://apcentral.collegeboard.org/pdf/ap-computer-science-principles-course-and-exam-description.pdf> (accessed 6/1/2018).
23. Measuring the Information Society Report 2017, International Telecommunication Union, Geneva, Switzerland, 2017.
24. <http://one.laptop.org/> (accessed July 2018).

## Chapter 2

1. *Webster's New Collegiate Dictionary*, 1977, s.v. "positional notation."
2. G. Ifrah, *From the Abacus to the Quantum Computer: The Universal History of Computing* (John Wiley & Sons, 2001): 245.
3. D. Schmandt-Besseerat, "One, Two . . . Three," *Odyssey*, September /October 2002: 6–7.
4. [http://en.wikipedia.org/wiki/United\\_States\\_Foreign\\_Intelligence\\_Surveillance\\_Court](http://en.wikipedia.org/wiki/United_States_Foreign_Intelligence_Surveillance_Court) (accessed 2/21/2014).
5. [http://www.fjc.gov/history/home.nsf/page/courts\\_special\\_fisc.html](http://www.fjc.gov/history/home.nsf/page/courts_special_fisc.html) (accessed 2/22/2014).
6. Congressional Research Service, "Reauthorization of the FISA Amendments Act," R42725.
7. *The Week*, January 19, 2018.

### Chapter 3

1. Character set maze from draft article by Bob Bemer.
2. <http://www.bobbemer.com/AWARD.HTM>
3. K. Dozier, "Intelligence Chief Reveals More on NSA Authorizations," *Austin American-Statesman*, December 22, 2013.
4. [http://www.nytimes.com/interactive/2013/12/18/us/recommended-changes-to-the-nsa.html?\\_r=0](http://www.nytimes.com/interactive/2013/12/18/us/recommended-changes-to-the-nsa.html?_r=0) (accessed 2/22/2014).
5. <http://www.cnn.com/2014/01/17/politics/obama-nsa-changes/> (accessed 2/22/2014).

### Chapter 4

1. Written by C. Weems, adapted from: N. Dale, C. Weems, and M. Headington, *Java and Software Design* (Sudbury, MA: Jones and Bartlett Publishers, 2001): 2423.
2. <http://www.nano.gov/nanotech-101/what/definition> (accessed 9/17/2011).
3. R. Orr, "Augustus DeMorgan," <http://www.engr.iupui.edu/~orr/webpages/cpt120/mathbios/ademo.htm>.
4. M. Campbell-Kelly, "Historical Reflections," *Communications of the ACM*, September 2011.
5. IEEE Code of Ethics, <http://www.ieee.org/about/corporate/governance/p7-8.html>.

### Chapter 5

1. M. Campbell-Kelly, "Historical Reflections," *Communications of the ACM*, September 2011.
2. *Austin American-Statesman*, 6/20/2013, 1/10/2014, and 1/11/2014.
3. A. Perlis, "Epigrams on Programming," *ACM Sigplan Notices*, October 1981: 713.
4. *Austin American-Statesman*, 12/10/2013.
5. Webopedia, s.v. "embedded systems," [http://webopedia.com/TERM/E/embedded\\_system.htm](http://webopedia.com/TERM/E/embedded_system.htm).
6. The Ganssle Group, "Microcontroller C Compilers," <http://www.ganssle.com/articles/acforuc.htm>.
7. <http://en.wikipedia.org> (accessed 5/14/2009).

## Endnotes

### Chapter 6

1. Pep/1 through Pep/9 are virtual machines designed by Stanley Warford for his textbook *Computer Systems* (Sudbury, MA: Jones and Bartlett, 2017).
2. [http://www.nytimes.com/2014/01/12/opinion/sunday/friedman-if-i-had-a-hammer.html?\\_r=0](http://www.nytimes.com/2014/01/12/opinion/sunday/friedman-if-i-had-a-hammer.html?_r=0) (accessed 3/16/2014).
3. <http://www.nytimes.com/2014/02/16/technology/intels-sharp-eyed-social-scientist.html> (accessed 2/21/14).
4. [http://en.wikipedia.org/wiki/Pandora\\_Radio](http://en.wikipedia.org/wiki/Pandora_Radio) (accessed 3/17/2014).
5. <http://www.nndb.com/people/538/000126160/> (accessed 3/18/2014).
6. [http://en.wikipedia.org/wiki/Konrad\\_Zuse](http://en.wikipedia.org/wiki/Konrad_Zuse) (accessed 3/18/2014).
7. <http://www.idsia.ch/~juergen/zuse.html> (accessed 3/18/2014).
8. <http://www-history.mcs.st-and.ac.uk/Biographies/Zuse.html>
9. Software Management: Security Imperative, Business Opportunity, June 2018.
10. [www.businessinsider.com/software-piracy-rates-and-value-by-country-2016-7](http://www.businessinsider.com/software-piracy-rates-and-value-by-country-2016-7) (accessed June 1, 2018).
11. [http://news.cnet.com/8301-1023\\_3-20004783-93.html#-comment](http://news.cnet.com/8301-1023_3-20004783-93.html#-comment) (accessed 8/20/2011).
12. <http://expandedramblings.com/index.php/pandora-statistics> (accessed 5/11/2018).

### Chapter 7

1. G. Polya, *How to Solve It: A New Aspect of Mathematical Method*, 2nd ed. (Princeton, NJ: Princeton University Press, 1945).
2. <http://www.fbi.gov/news/stories/2013/august/pirated-software-may-contain-malware> (accessed 3/16/2014).
3. S. P. Zehler, letter to the editor of *The Wall Street Journal*, March 16, 2014.
4. GNU General Public License, <http://www.gnu.org/copyleft/gpl.html> (accessed 8/28/2011).
5. [http://en.wikipedia.org/wiki/Open-source\\_software](http://en.wikipedia.org/wiki/Open-source_software) (accessed 1/19/2014).
6. *The Week*, January 19, 2018.

### Chapter 8

1. *Austin American-Statesman*, "UTeach Program Looks for Better Uses of Classroom Technology," December 4, 2013.
2. S. Warford, *Computer Systems* (Sudbury, MA: Jones and Bartlett Publishers, 1999): 146.

3. "Who Needs Banks? PayPal and Lending Club Want to Make Small Business Loans," *Bloomberg Businessweek*, March 20, 2014.
4. Privacy Rights Clearinghouse, "Workplace Privacy and Employee Monitoring," <https://www.privacyrights.org/fs/fs7-work.htm> (accessed 8/26/2011).
5. "Workplace privacy? Forget it!" <http://www.bankrate.com/brm/news/advice/20050718a1.asp> (accessed 8/26/2011).

## Chapter 9

1. *Webster's New Collegiate Dictionary*, 1977, s.v. "brainstorming."
2. G. Booch, "What Is and Isn't Object Oriented Design," *American Programmer* 2, no. 78 (Summer 1989).
3. <http://www.microsoft.com/en-us/news/press/2013/mar13/03-05playitsafepr.aspx> (accessed 3/16/2014).
4. T. W. Pratt, *Programming Languages: Design and Implementation*, 2nd ed. (Englewood Cliffs, NJ: Prentice-Hall, 1984): 604.
5. <http://www.yourdictionary.com/paradigm#americanheritage> (accessed 9/4/2014).
6. <http://whatis.techtarget.com/search/query?q=paradigm> (accessed 9/4/2014).
7. K. C. Loudon, *Programming Languages: Principles and Practice* (Boston: PWS-Kent Publishing Company, 1993).
8. SISC: Second Interpreter of Scheme Code, <http://sisc-scheme.org/sisc-online.php> (accessed 6/9/2009).
9. J. B. Rogers, *A Prolog Primer* (Reading, MA: Addison-Wesley, 1986).
10. O. Dahl, E. W. Dijkstra, and C. A. R. Hoare, *Structured Programming* (New York: Academic Press, 1972).
11. S. Warford, *Computer Systems* (Sudbury, MA: Jones and Bartlett Publishers, 1999): 222.
12. S. P. Zehler, letter to the editor of *The Wall Street Journal*, March 16, 2014.
13. <http://www.hoax-slayer.com/> (accessed 8/22/2011).
14. <http://www.ftc.gov/opa/2010/02/2009fraud.shtm> (accessed 8/22/2011).

## Chapter 10

1. "Bitcoin Explained: Crypto Fad or the Future of Money?" *ExtremeTech*, February 7, 2014.
2. Privacy Rights Clearinghouse, <https://www.privacyrights.org/fs/fs8a-hipaa.htm> (accessed 8/25/2011).

## Endnotes

3. Summary of the HIPAA Privacy Rule, United States Department of Health and Human Services.
4. <http://charts.bitcoin.com/chart/price> (accessed 5/17/2018).

## Chapter 11

1. <http://www.lsoft.com/resources/optinlaws.asp> (accessed 8/23/2011).
2. S. Daley of *The New York Times*, "Europe sees 'right to be forgotten' as Web privacy issue." *Austin American-Statesman*, August 15, 2011.

## Chapter 12

1. "New Tech Keeps Eye on Senior Parents," *Austin American-Statesman*, March 16, 2014.
2. Email to one of the authors, 4/11/2014.
3. M. Scherer, "Inside the Secret World of Quants and Data Crunchers Who Helped Obama Win," *Time*, November 7, 2012.
4. <https://www.nbcnews.com/politics/white-house/trump-replaces-secretary-state-tillerson-cia-director-n856091> (accessed 6/1/2018).
5. *The Washington Post*, January 5, 2017, "U.S. Intelligence Official: Russia meddled in election by hacking, spreading of propaganda," by Ellen Nakashima, Karoun Demirjian, and Philip Rucker.

## Chapter 13

1. D. Kortenkamp, R. P. Bonasso, and R. Murphy, *Artificial Intelligence and Mobile Robots* (Menlo Park, CA: AAAI Press/The MIT Press, 1998).
2. J. Weizenbaum, *Computer Power and Human Reason* (San Francisco: W. H. Freeman, 1976): 34.
3. R. A. Brooks, "A Robust Layered Control System for a Mobile Robot," *IEEE Transactions on Robotics and Automation* 2, no. 1:1423.
4. Mars Now Team and the California Space Institute, October 6, 2001.
5. J. H. L. Jones and A. M. Flynn, *Mobile Robots: Inspiration to Implementation* (Wellesley, MA: A K Peters, 1993): 175.
6. <http://stocks.about.com/od/advancedtrading/a/UnderstandIPO.htm> (accessed 3/27/2014).
7. <https://www.briefing.com/investor/learning-center/general-concepts/how-ipos-work/> (accessed 3/27/2014).
8. <http://www.investopedia.com/university/ipo/ipo.asp> (accessed 3/27/2014).

## Chapter 14

1. M. Pidd, "An Introduction to Computer Simulation," *Proceedings of the 1994 Winter Simulation Conference*.
2. R. E. Shannon, "Introduction to the Art and Science of Simulation," *Proceedings of the 1998 Winter Simulation Conference*.
3. [http://heim.ifi.uio.no/~kristen/FORSKNINGSBOK\\_MAPPE/F\\_OO\\_start.html](http://heim.ifi.uio.no/~kristen/FORSKNINGSBOK_MAPPE/F_OO_start.html).
4. D. R. Stauffer, N. L. Seaman, T. T. Warner, and A. M. Lario, "Application of an Atmospheric Simulation Model to Diagnose Air-Pollution Transport in the Grand Canyon Region of Arizona," *Chemical Engineering Communications* 121 (1993): 925.
5. "Some Operational Forecast Models," *USA Today Weather* (November 8, 2000), <http://www.usatoday.com/weather/wmodlist.htm>.
6. D. R. Stauffer, N. L. Seaman, T. T. Warner, and A. M. Lario. "Application of an Atmospheric Simulation Model to Diagnose Air-Pollution Transport in the Grand Canyon Region of Arizona," *Chemical Engineering Communications* 121 (1993): 925.
7. "2013 Atlantic Hurricane Season's Dire Predictions Were a Dud," WTSP.com, November 12, 2013.
8. *Austin American-Statesman*, February 20, 2014.
9. *The New York Times*, October 19, 2014. [http://www.nytimes.com/2014/10/19/fashion/how-apples-siri-became-one-autistic-boys-bff.html?smprod=nytcore-ipad&smid=nytcore-ipad-share&\\_r=0](http://www.nytimes.com/2014/10/19/fashion/how-apples-siri-became-one-autistic-boys-bff.html?smprod=nytcore-ipad&smid=nytcore-ipad-share&_r=0)

## Chapter 15

1. D. Sefton, Newhouse, News Service, *Austin American-Statesman*, April 27, 2001.
2. M. Softky, "Douglas Engelbart: Computer Visionary Seeks to Boost People's Collective Ability to Confront Complex Problems Coming at a Faster Pace," *The Almanac*, February 21, 2001.
3. "The Psychology of Video Game Addiction," *The Kernel*, February 6, 2014.
4. *The New York Times*, October 7, 2014.
5. M. O'Toole, "Social Networking Boosts Teen Drug Abuse Risk—Study," Reuters, August 25, 2011.
6. <http://www.pewinternet.org/fact-sheets/social-networking-fact-sheet/> (accessed 1/23/2014).

## Endnotes

### Chapter 16

1. [http://en.wikipedia.org/wiki/Tim\\_Berners-Lee](http://en.wikipedia.org/wiki/Tim_Berners-Lee) (accessed 1/23/2014).
2. *Austin American-Statesman*, December 22, 2013.
3. D. Watts, "Six Degrees: The Science of a Connected Age."
4. A. Jeffries, "Congress to Consider Banning Online Gambling," *The Verge*, March 26, 2014.
5. N. Vardi, "Department of Justice Flip-Flops on Internet Gambling," *Forbes.com*, December 23, 2011.

### Chapter 17

1. [http://en.wikipedia.org/wiki/Radio-frequency\\_identification](http://en.wikipedia.org/wiki/Radio-frequency_identification) (accessed 4/9/2014).
2. "Rude Alec Baldwin Fled to Toilet, Booted from Plane," *CNN*, December 7, 2011.
3. "Alec Baldwin Thrown Off AA Flight at LAX for 'Playing Game' on Phone," *New York Post*, December 6, 2011.
4. [http://en.wikipedia.org/wiki/Mavis\\_Batey](http://en.wikipedia.org/wiki/Mavis_Batey) (accessed 4/15/14).
5. "Mavis Batey—Obituary," *The Telegraph*, November 13, 2013.
6. "Mavis Batey Obituary," *The Guardian*, November 20, 2013.
7. J. Mintz, "When Bloggers Make News," *The Wall Street Journal*, January 21, 2005: B1.
8. Editorial, "The Apple Case Isn't Just a Blow to Bloggers," *BusinessWeek*, March 28, 2005: 128.
9. J. Mintz, "When Bloggers Make News," *The Wall Street Journal*, January 21, 2005: B4.
10. <http://www.cybintsolutions.com/cyber-security-facts-stats/> (accessed 5/30/2018).

### Chapter 18

1. H. M. Walker, *The Limits of Computing* (Sudbury, MA: Jones and Bartlett Publishers, 1994). This fable and many of the ideas in this chapter come from Dr. Walker's thought-provoking little book. Thank you, Henry.
2. "Has Privacy Become a Luxury Good?" *The New York Times*, March 3, 2014.
3. *Software Engineering Note* 11, no. 1 (January 1986): 14.
4. J. Markoff, "Circuit Flaw Causes Pentium Chip to Miscalculate, Intel Admits," *The New York Times*, November 24, 1994.
5. *Austin American-Statesman*, November 27, 2013.
6. "IBM Wants Developers to Make Watson Mobile," *Re/code*, February 26, 2014.

7. N. G. Leveson, "Software Engineering: Stretching the Limits of Complexity," *Communications of the ACM* 40, no. 2 (February 1997): 129.
8. D. Bell, I. Morrey, and J. Pugh, *Software Engineering, A Programming Approach*, 2nd ed. (Prentice Hall, 1992).
9. T. Huckle, *Collection of Software Bugs*, <http://www5.in.tum.de/~huckle/bugse.html>.
10. D. Beeson, Manager, Naval Air Warfare Center, Weapons Division, F18 Software Development Team.
11. D. Gries, "Queen's Awards Go to Oxford University Computing and INMOS," *Computing Research News* 2, no. 3 (July 1990): 11.
12. "Out in the Open," *The Economist*, April 2001.
13. E. Dijkstra, "On the Cruelty of Really Teaching Computing Science," *Communications of the ACM* 32, no. 12 (December 1989): 1402.
14. "Out in the Open," *The Economist*, April 2001.
15. S. J. Vaughan-Nichols, "Coverity Finds Open Source Software Quality Better Than Proprietary Code," *ZDNet*, April 16, 2014.
16. <http://en.wikipedia.org/wiki/SourceForge> (accessed 4/19/2014).
17. N. Perlroth, "Heartbleed Highlights a Contradiction in the Web," *The New York Times*, April 18, 2014.
18. "Ghost in the Machine," *Time*, January 29, 1990: 59.
19. T. Huckle, "Collection of Software Bugs," <http://www5.in.tum.de/~huckle/bugse.html>.
20. Douglas Arnold, "The Patriot Missile Failure," <http://www.ima.umn.edu/~arnold/disasters/patriot.html>.
21. United States General Accounting Office Information Management and Technology Division, B247094, February 4, 1992.
22. J. Fox, *Software and Its Development* (Englewood Cliffs, NJ: Prentice-Hall, 1982): 187–188.
23. D. Isbell and D. Savage, "Mars Polar Lander," 1999, <http://mars.jpl.nasa.gov/msp98/news/mco991110.html>.
24. Email received by N. Dale on 9/27/2011.
25. P. Gray, "Computer Scientist Alan Turing," *Time*, <http://www.time.com/time/time100/scientist/profile/turing.html>.
26. Ibid.
27. N. G. Leveson and C. S. Turner, "An Investigation of the Therac25 Accidents," *IEEE Computer* 26, no. 7 (July 1993): 1841.





# INDEX

© Artur Debat/Getty Images, © Alan Dyer/Stocktrek Images/Getty Images

*Biographies, figures, and tables are indicated by “b,” “f,” and “t” following page numbers.*

## A

- Abacus, 9, 40
- Absolute path name, 372
- Abstract art, 8
- Abstract data type (ADT), 241, 242
- Abstract numerals, 12
- Abstract step, 205
- Abstraction, 6–8, 27*t*, 113, 229–230, 229*f*, 313
  - car engine and, 7–8, 7*f*
  - defined, 6
  - subprograms and, 222
- Access control policy, 509
- Access time, 137
- Accumulator, in Pep/9, 154
- ACM. *See* Association for Computing Machinery
- Action-adventure games, 483
- Action games, 483
- Action responsibilities, 286
- Ada (programming language), 10
- Adams, E. N., 603
- Adders, 108–109
- Addiction, gaming as, 489–490
- Addition
  - of integers, 302
  - of numbers in other bases, 41
- Address binding, 337
  - for fixed and dynamic partitions, 340
- Address of argument, reference parameter and, 268
- Address resolution, in partition memory management, 340, 340*f*
- Addressability, 128
- Addresses, 15, 336–337
  - kinds of, 337
  - network addresses, 510–513
- Addressing mode specifier, in Pep/9, 155
- Adjacent vertices, 257
- Adobe Flash, 84
- ADT. *See* Abstract data type
- Advanced Research Projects Agency (ARPA), 18, 462
- Adware, 288
- AI. *See* Artificial intelligence
- Aibo, demise of, 444
- AIFF format, 79
- ALGOL (programming language), 293
- Algorithmic thinking, 26
- Algorithms, 27*t*, 44, 171. *See also* Boolean
  - expressions; Boolean variables; Responsibility algorithms
  - classification of, 617–618
  - comparing, 605–612
  - defined, 194
  - development phase, in computer problem-solving process, 196, 196*f*
  - expressing, 171–182
  - nesting in, 310
  - following pseudocode algorithm, 175–177
  - pseudocode functionality, 171–175
  - recursive, 221–228
  - with repetition
    - count-controlled loops, 200–201
    - event-controlled loops, 201–203
    - square root, 203–206
  - searching
    - binary search, 212–214
    - sequential search, 208–209
    - sequential search in sorted array, 209–211
  - with selection, 199–200
  - summary of methodology
    - analyzing problem, 197
    - listing main tasks, 197–198
    - re-sequence and revise as necessary, 198
    - writing remaining modules, 198
  - testing, 198
  - translating pseudocode algorithm, 180–182
  - writing pseudocode algorithm, 177–180
- Allen, Paul, 508
- Allen, Robert, 602
- Alliance for Affordable Internet, 539
- Amazon Web Services, 516
- Amazon.com, 407
- AMBER Alert, 254

- America Online (AOL), 24
- American Management Association, 273
- American National Standards Institute (ANSI), 404
- American Standard Code for Information Interchange (ASCII). *See* ASCII character set
- Ampersand (&), in C++, 310
- Analog data, 57–59
- Analog signal, degradation of, 58–59, 59*f*
- Analysis, algorithm design and, 197
- Analysis and specification phase, in computer problem-solving process, 196, 196*f*
- Analytical Engine, 9, 10
- AND Boolean operator, 98, 105, 209, 301
- AND gate, 97–98, 97*f*
  - combinational circuit and, 104
  - constructing, 103–104
  - three-input, 101, 101*f*
- Andreesen, Marc, 24
- Android, 331
- Angle brackets, HTML tags within, 535
- Animation, 480–482
- Annals of Mathematics, 248
- ANSI. *See* American National Standards Institute
- Antivirus software, 566–567
- AOL. *See* America Online
- APL, 293
- APNG (Animated Portable Network Graphics), 83
- Apple Computer, 16, 23, 331, 348, 580
- Apple I, 17
- Apple II, 395
- Apple iPhone. *See* iPhone
- Apple Macintosh, 23
- Applets, 541
- Application (or user) level, 242
- Application packages, 22*f*
- Application software, 330, 387
- Application systems, 6
- Applications layer, in computing system, 5
- Applications programmers, 21, 22, 24–25
- Arguments, 223, 266
- Arithmetic, in other bases, 41–42
- Arithmetic, limits on
  - integer numbers, 588–589
  - real numbers, 589–593
- Arithmetic operations
  - integers and, 302
  - spreadsheet formulas and, 392
- Arithmetic/logic unit (ALU), 129–130
- ARPA. *See* Advanced Research Projects Agency
- ARPANET, 18, 514
- Arrays, 206–207
  - algorithm putting values into places in, 207
  - lists *vs.*, 244
  - sequential search in, 209–211
  - sorted, 210*f*
  - with ten numbers, 207*f*
  - unsorted, 210*f*
- Artificial intelligence (AI), 6, 298, 419–447
  - branches of, 423
  - computer limitations, 420*f*
  - defined, 419, 421
  - expert systems, 430–432
  - knowledge representation, 423–429
  - Lisp and, 20
  - natural language processing, 435–440
  - neural networks, 432–435
  - robotics, 440–445
  - search trees, 427–429
  - semantic networks, 425–427
  - subsumption architecture, 441–443
  - thinking machines, 420–423
- Artificial neural networks, 433–435
- Artists, computer graphics used by, 469
- ASCII character set, 69–70, 70*f*, 302–303, 306, 362
  - output from operand in Pep/9, 159
- .ASCII pseudo-op, 165
- Asimov, Isaac, 443*f*
- Asking questions strategy, 178
- Assange, Julian, 577
- Assemblers, 20, 163, 291
  - directives, 165
- Assembly language, 19, 163–170, 191, 281, 291
  - assembler directives, 165
  - first-generation software, 19, 20*f*

- loops in, 170
  - mnemonic letter codes assigned by, 163
  - numeric data, branches, and labels, 166–169
  - Pep/9, 164–166
  - second-generation software, 20, 21*f*
  - third-generation software, 21–22, 22*f*
  - Assertions, 299
  - Assignment
    - in pseudocode algorithm, 171–172
    - statements, 97
  - Association for Computing Machinery (ACM), 47, 100, 309
    - Code of Ethics, 115
  - Associative property, 107*t*
  - Asterisk (\*)
    - for AND operation, 98
    - in select clause, 404
  - Asynchronous processing, 312–313
  - AT&T™, 23
    - nine-hour failure (1990), 602–603
  - Atanasoff, John Vincent, 127
  - Atari, 16, 18
  - Atari 2600, 483
  - Atomic data types, 303
  - Atomic Energy Commission, 248
  - Attributes, 536
    - of database objects, 400
    - in discrete-event models, 456–457
    - tag attributes, 534–535
  - AU format, 79
  - Audio data, 77–80
    - audio formats, 79
    - MP3 audio format, 79–80
  - Audio formats, 79–80
  - Audio signal, sampling, 78, 78*f*
  - Augusta, Ada (Countess of Loveless), 9, 10, 11, 14–15
  - Austin American-Statesman, 146
  - Authentication credentials, 560
  - Automobile diagnostic programs, 330
  - Auxiliary storage devices, 13, 15. *See also* Secondary storage devices
  - Availability of information, 559
  - Average wait time, in queuing model, 458
  - Axon, 432
- ## B
- Babbage, Charles, 10, 14
  - Back door, 568
  - Backslash, root of directory system and, 369
  - Backus, John, 248
  - Baldwin, Alec, 572
  - Baldwin, Brooke, 572
  - Bandwidth, 56, 496
  - Barcode, 402, 559
  - Bardeen, John, 13
  - Base
    - of number system, 37
    - transistor, 102
  - Base 10, converting from, to other bases, 37, 44–45
  - Base case
    - in recursive algorithm, 221
    - for recursive factorial, 223
  - Base register, 341
  - BASIC, 23, 295
  - Batch jobs, 333
  - Batch processing, 333–334, 333*f*
  - Batey, Mavis, 576*b*
  - Battery capacity, in laptops, 125
  - Bay, Austin, 146
  - Bell, Genevieve, 170
  - Bell Labs, 102
  - Bemer, Bob, 72
  - Berners-Lee, Tim, 24, 538–539*b*
  - Berry, Clifford, 127
  - Best fit, 341
  - Bi-quinary number representation, 41
  - Big data, 408
  - Big-O analysis
    - common orders of magnitude, 610–612, 612*f*
    - family laundry analogy, 609
    - traveling salesman problem, 618
  - Big-O notation, defined, 607
  - Bill and Melinda Gates Foundation, 508

- Bina, Eric, 24
- Binary files, 362–363
- Binary floating-point value, 67
- Binary numbers, 5, 38–41
  - to other bases, 42–44, 43*t*
- Binary programmable computer, 11
- Binary representations, 59–61
- Binary search, 212–214, 212*f*
  - average number of comparisons with sequential search and, 213*t*
- Binary search trees, 249–255
  - building, 251–254
    - from strings, 253*f*
  - four-level, 251
  - printing data in, 254–255, 255*t*
  - searching, 250–251
  - ten-level, 251
  - trace for, 253, 254*t*
- Binary system, 5, 38, 56, 58. *See also* Bit
  - counting in, with octal and decimal equivalents, 43, 43*t*
  - data, CD player and reading of, 79, 79*f*
  - rules of binary arithmetic, 41–42
- Binary trees, 247–249, 249*f*
- Binary values, and number systems, 35–49
  - and computers, 45–47
  - numbers and computing, 36
  - positional notation, 36–47
    - arithmetic in other bases, 41–42
    - binary, octal, and hexadecimal, 38–41
    - binary values and computers, 45–47
    - converting from base 10 to other bases, 44–45
    - power-of-2 number systems, 42–44
- Binding of addresses, 337–338
- Biographies
  - Atanasoff, John Vincent, 127*b*
  - Batey, Mavis, 576*b*
  - Bemer, Bob, 72*b*
  - Berners-Lee, Tim, 538–539*b*
  - Boole, George, 95*b*
  - Bricklin, Daniel, 395–396*b*
  - Dijkstra, Edsger W., 309*b*
  - Engelbart, Doug, 503*b*
  - Hoare, Tony, 377–378*b*
  - Hollerith, Herman, 130*b*
  - Hopper, Grace Murray, 46*b*
  - Jobs, Steve, 349*b*
  - Lovelace, Ada (Countess of Lovelace), 14–15*b*
  - Polya, George, 195*b*
  - Simon, Herbert A., 424*b*
  - Sutherland, Ivan, 462–463*b*
  - Turing, Alan M., 613–614*b*
  - von Neumann, John, 248*b*
  - Zuse, Konrad, 181*b*
- Bioinformatics, 466
- Biological neural networks, 432–433, 433*f*
- Biological neuron, 432
- Biometrics, 560
- Bit, 47, 128
- Bit combinations, 60*f*
- Bit-level parallelism, 142
- Bitcoin, 341, 516
- Bitmap file, 82
- Bits, 362
  - binary representations and, 59–61
- Black-box testing, 182, 231
- Blaster worm, 565
- Bletchley Girls, 576, 608
- Block, 136
  - .BLOCK pseudo-op, 165
- Block record, 516
- Blockchain, 516–517
- Blogs and blogging, 24, 529
  - presidential elections and, 411
- Blu-Ray disks, 124, 138
- Bluetooth, 125, 499
- Boggs, David, 17
- Booch, Grady, 286
- Boole, George, 14, 94, 95*b*, 107
- Boolean algebra, 14, 27, 94, 95
  - combinational circuit expressed with use of, 105
  - properties of, 107*t*
- Boolean binary search, 213, 213*f*

Boolean expressions, 299–301  
     control structures, 307–310  
     data typing, 301–304  
     input/output structures, 305–307  
     and variables, 94, 174, 299–301, 303  
 Boolean variables, 303  
     characters, 302–303  
     defined, 301  
     integers, 302  
     reals, 302  
     simple, 303  
     strings, 303–304  
 Booting, 330  
 Bottom-up approach, 5  
 Bounded rationality theory, 424  
 Bounded time, 610  
 Bounds register, 341  
 Braces, in Java and C++, 308  
 Brainstorming, 283–284  
     example, 286–289  
 Branch instructions, 167  
 Brattain, Walter H., 13  
 Breadth-first search, 261–264, 263*f*,  
     429, 429*f*  
 Break-even calculations, spreadsheets and, 398  
 BREQ branch instruction, 167  
 Bricklin, Daniel, 395*b*  
 BRLT branch instruction, 167, 169  
 Broadband, 501  
 Browsers, 24, 514, 526, 527*f*  
 Bubble sort algorithm, 218–219, 218*f*  
 Buffer overflow, 568  
 Bugs, 46, 594, 600  
     in government projects, 603–604  
 Bullets, 536  
 Bullying, social networking and, 519  
 Bureau of Ordnance Computation Project  
     (Harvard), 46  
 Burning, 134  
 Burroughs Corporation, 16  
 Burroughs, William, 10  
 Bus, 122, 498  
     width, 131

Bush, George H.W., 127  
 Bush, George W., 86  
     election strategies, 411  
 Business and economic forecasting models, 467  
 Business Software Alliance, 185  
 Byron, Lord George Gordon, 10  
 Byte, 47  
 Bytecode, 293  
 Bytes, 128, 362

## C

C language, 23, 295  
 C++ language, 23, 295, 301  
     braces in, 308  
     compiling of, 294*f*  
     if and while statements in, 308  
     input statement in, 307  
     subprogram declaration in, 310  
     uppercase and lowercase used in, 305  
     variable declaration in, 304  
 Cable modems, 500  
 Cache memory, 123, 131  
 CAD. *See* Computer-aided design  
 Caesar cipher, 569  
 Calling unit, 221, 317  
 Cambridge Analytica, 574  
 Cambridge Mathematical Journal, 95  
 CAN-SPAM Act, 380  
 Cancellation error, 593  
 Capacitive touch screen, 140  
 CAPTCHA, 563–564, 564*f*  
 Car engine, abstraction and, 7–8, 7*f*  
 Cardinality constraints, 406  
 Carry-in, 109, 109*f*  
 Carry-out, 109, 109*f*  
 Carry value, 108  
 Cartesian product operation, in SQL, 405  
 Cascading Style Sheets (CSS), 532–533, 537–540  
 Case-sensitive languages, 305  
 Catenary curve, 479  
 CD. *See* Compact disc

- Cells, 128
  - in spreadsheets, 389, 389*f*
- Census Bureau, U.S., 130
- Central Intelligence Agency (CIA), 86
- Central processing unit (CPU), 5, 131
  - chips, 113
  - scheduling algorithms, 332, 345–350
    - first come, first served, 347–348
    - nonpreemptive, 346
    - preemptive, 346
    - round robin, 348–350
    - shortest job next, 348
- Ceruzzi, Paul E., 18
- Change directory, 372
- Character set, 69, 302–303
- Chat room, 528
- Chatbot, 423
- Check bit, 69
- Check digits, 595–596
  - in Universal Product Code, 402
- Chemistry Markup Language (CML), 546
- Children, in binary search trees, 247, 249
- Chip, 112
  - CPU, 113
- Chrome, 24
- Church, Alonzo, 615
- Church-Turing thesis, 615
- CIA (confidentiality, integrity, and availability) triad, 559, 559*f*
- Cinepak, 85
- Cipher, 569
- Ciphertext, 569
- Circuits, 5, 94, 104–111, 104–113
  - adders, 108–109
  - boards, 15
  - combinational, 104–107
  - combinational circuits, 104–107
  - equivalence, 106
  - integrated, 112–113
  - as memory, 111
  - multiplexers, 110–111
  - sequential, 104
- Circular references, 396, 396*f*
- Clapper, James, 86
- Class (implementation phase), 314
- Class NP problems, 618, 618*f*
- Class P, 611, 617
- Classes, 282, 314–316
  - mapping objects into, 291*f*, 296
  - responsibilities assigned to, 285
- Clear-box testing, 182, 231
- Client/server model, 496, 496*f*
- Clock, 122
- Cloud computing, 6, 18–19, 515–516, 515*f*
- Clustering, 528
- Clusters, 144
- CML. *See* Chemistry Markup Language
- COBOL, 20, 46, 72, 293
- CODASYL, 72
- Codd, E. F., 405
- Code, 191
  - error-correcting, 596
  - errors per lines of, 600
- Code coverage (clear-box) testing, 182
- Codec, 84
- Codes of Ethics, 113
- Collision detection algorithms, 484
- Color
  - for data in cells in spreadsheets, 391
  - indexed, 83
  - representing, 80–82
- Color bleeding, 474
- Color depth, 80
- Color palette, restricted, 81*f*
- Color photoreceptor cone cells, in retina, 80
- Color space, 80
- Colossus computer, 11, 11*f*
- Column designations, spreadsheet cells, 389
- Combinational circuits, 104–107
- Combinatorial theory, 195
- Comment symbol, 304
- Comments, 165
  - prefacing, 201
- Commodore, 16
- Common orders of magnitude, 610–612, 612*f*



- Communications, 5
  - in computing systems, 4
  - limits on, 595–596
    - check digits, 595–596
    - error-correcting code, 596
    - error-detecting code, 595
    - parity bits, 595
- Communications of the ACM* (article), 69, 597
- Community cloud, 516
- Commutative property, 107*t*
- Compact disc (CD), 79, 138–139
  - CD-DA, 138
  - CD player, binary data read by, 79, 79*f*
  - CD-R, 138
  - CD-ROM, 138
  - CD-RW, 138
- Compaction, 341
- Compaq, 16, 594
- Compilation process, 292*f*
- Compilers, 21, 292
- Complement property, 107*t*
- Complex objects, modeling, 474–480
- Complex systems, 454
- Complexity software, 596–597
- Complicated systems, 454
- Components
  - architecture, 113
  - limits on, 594
- Composite variables, 206–208
  - arrays, 206–207
  - records, 207–208
- Compositio Mathematica*, 248
- Compression ratio, 57
- CompuServe, 83
- Computational biology, 466–467
- Computational biomodeling, 467
- Computational genomics, 467
- Computer Addiction Service, 489
- Computer-aided design (CAD), 468
- Computer bugs. *See* Bugs
- Computer ethics. *See* Ethical issues
- Computer gaming, 482–487. *See also* Games and gaming
- Computer graphics, 462–482
  - animation, 480–482
  - complex object modeling, 474–480, 476–479*f*
  - light and, 470–472, 471*f*
  - light simulation and, 472–474
  - object shapes and, 472
- Computer hardware. *See* Hardware
- Computer History Museum, 19
- Computer hoaxes and scams, 321–322
- Computer limitations. *See* Limitations on computing
- Computer mouse, 23, 503
- Computer network, defined, 496
- Computer operations, 152
- Computer operators, 335
- Computer problem-solving process, 196–197, 196*f*
- Computer professionals
  - ethics codes, 114, 115
  - licensing, 180
- Computer programming and philosophy, 311
- Computer science
  - computer graphics applications in, 468
  - curricula for, 100, 113
  - defined, 191
  - as discipline, 26
  - Tenth Strand (Social and Professional Issues), 100
- Computer security. *See* Security
- Computer software. *See* Software
- Computer terminals, 21
- Computers
  - and binary values, 45–47
  - data and, 56–61
  - and electricity, 94
  - predictions about, 25–26
  - virtual, 153–159
- Computers. *See* Hardware; Limitations on computing; Software
- Computing. *See also* Limitations on computing
  - components, 121–147
    - embedded systems, 141–142
    - individual, 122–126
    - parallel architectures, 142–145
    - stored-program concept, 126–141



- hardware/software, history of, 9–18
  - numbers and, 36
  - parallel, 142–144
  - predictions related to, 25–26
  - prefixes used in, 126
  - Computing Curricula* 1991 (ACM report), 100
  - Computing system, 4–7
    - abstraction, 6–7
    - big ideas of, 27–28
    - defined, 4
    - layers of, 4–6, 5f
    - predictions about, 25–26
    - as tool and discipline, 26–28
  - Concept-based searches, 528
  - Concrete step, 205
  - Conditions, 299
  - Confidentiality, 559
    - defined, 558
    - information security, 559
    - medical information and, 352–353
  - Containers, 242
  - Context switch, 346
  - Continuous simulation, 455–456
  - Control abstraction, 230
  - Control Data, 16
  - Control structures, 230, 307–310
    - asynchronous processing, 312–313
    - nested logic, 310–312
  - Control unit, 130–132
  - Conversion algorithm, walk-through of, 176f
  - Conversions
    - from base 10 to other bases, 44–45
    - from binary to hexadecimal, 43–44
    - in binary with octal and decimal equivalents, 43
    - of decimal numbers to hexadecimal, 45
    - of whole value from base 10 to another base, 67–68
  - Cook, Tim, 349
  - Cookies, 530
  - Copy aspect, of spreadsheets, 394
  - Copy of the argument, value parameter and, 268
  - Copyright, open-source software and, 232
  - Cores, 122
  - Corporate responsibility, 574
  - Cost-benefit analysis, spreadsheets and, 398
  - Count-controlled loops, 200–201
  - COUNT function, 393, 394f
  - Counterfeit software, 288
  - Counting and writing, 12
  - CPU. *See* Central processing unit
  - CPWA branch instruction, 167
  - Crackers and hackers, 267
  - Craft, Jon, 172
  - Craigslist, 407
  - CRC cards, 283, 288–289
    - inheritance and, 316–317
  - Creativity, 27t
  - Credit/debit card thefts, 132
  - Cryptanalysis, 570
  - Cryptocurrency, 341, 516
  - Cryptography, 569–572
  - CSP concurrent programming model, 377
  - CSS. *See* Cascading Style Sheets
  - Customer database table, 401, 401f
  - Customs and Border Protection, U.S., 575
  - Cyber-bullying, 519
  - Cybersecurity, 577
  - Cylinder, 137
- ## D
- Dahl, Ole-Johan, 458
  - Dale, Nell, 46, 322
  - Data, 56, 210, 387
    - analog and digital, 57–59
    - computers and, 56–61
    - digitization of, 57–59
    - and information, 27t, 56
    - printing in binary search tree, 254–255, 255t
  - Data abstraction, 230
  - Data center, 19
  - Data compression, 56
  - Data coverage (black-box) testing, 182
  - Data-level parallelism, 143, 144
  - Data management, 5

- Data objects, 286
- Data Processing Management Association, 46
- Data representations
  - audio data, 77–80
    - audio formats, 79
    - MP3 audio format, 79–80
  - data and computers, 56–61
    - analog and digital data, 57–59
    - binary representations, 59–61
  - images and graphics
    - digitized, 82–83
    - representing color, 80–82
    - vector representation of graphics, 83–84
  - numeric data
    - negative values, 61–65
    - real numbers, 65–68
  - text, 68–77
    - ASCII character set, 69–70
    - text compression, 71–77
    - Unicode character set, 70–71
  - video, 84–85
- Data structures, 242
- Data transfer rate (bandwidth), 496
- Data types, 301–304
  - atomic, 303
- Database content, modifying, 405
- Database design, 405–406
- Database management systems, 23, 387
  - database design, 405–406
  - defined, 399
  - elements of, 399*f*
  - relational model, 399–403
  - relationships, 403–404
  - Structured Query Language, 404–405
- Databases, 409
  - defined, 399
  - object, 400
  - table made up of records and fields, 400*f*
- dBase IV, 23
- De Morgan's law, 107
- Dean, Howard, 411
- DEC. *See* Digital Equipment Corporation
- DECI branch instruction, 167
- Decimal notation, 67*t*
- Decimal number system, 5
  - to other bases, 44–45
- Declarations, 304–305
- Declarative paradigm
  - functional model, 296–297
  - logic programming, 297–298
- Decryption, 569
- Deep Blue computer chess program, 429
- Deferring details strategy, pseudocode algorithm
  - and, 178
- Delete statement, in SQL, 405
- Deletions, spreadsheet formulas and, 393
- Dell, 16, 594
- Delta frames, 85
- Demand paging, 343
- DeMorgan, Augustus, 14, 107
- Demultiplexer, 111
- Dendrites, 432
- Denial of service, 569
- Denning, Peter, 26
- Depth-first search, 259–261, 260*f*, 429, 429*f*
- Derived class, 316
- Dertouzos, Michael, 538–539
- Design skill, 26
- Desk checking, 180
- Desktop replacements, 125
- Diagnostic and Statistical Manual of Mental Disorders* (DSM), 490
- Difference Engine, 14
- Difference operation, in SQL, 405
- Digital camera, built-in, for laptop, 125
- Digital certificate, 571
- Digital circuits, role of, 111
- Digital currency, 341
- Digital data, 57–59
- Digital divide, 30
- Digital Equipment Corporation (DEC), 19, 395
- Digital signals, 58
- Digital signature, 571
- Digital subscriber line (DSL), 501
- Digital trail, 408

Digital versatile disk (DVD), 138  
 drive, 124  
 DVD+/-R, 122

Digital world, 482

Digitization of data, 57–59

Digitized images and graphics, 82–83

Dijkstra, Edsger W., 307, 309*b*, 601

Direct addressing mode, 155

Direct file access, 367

Directed graph (digraph), 256, 425

Directories, 362, 368–373  
 defined, 368  
 directory trees, 369–371  
 path names, 371–373

Directory trees, 369–371  
 UNIX, 371, 371*f*  
 Windows, 369, 370*f*

Discipline, 26

Discrete-event simulation, 456–457

Disk drive, 136

Disk scheduling, 373–378  
 defined, 374  
 first-come, first-served disk scheduling, 375  
 SCAN, 376–378  
 shortest-seek-time-first, 375–376

Disks, varieties of, 136

Distributed computers, 144

Distributive law, 106

Distributive property, 107*t*

Divide and conquer strategy  
 problem solving and, 194  
 quicksort algorithm and, 224

Division, of integers, 302

DL DVD-R, 138

DNS. *See* Domain name system

Document Type Definition (DTD), 544

Domain name servers, 514

Domain name system (DNS), 511–514

Domain squatting, 512

Donner, Jan Hein, 158

“Dot-com” collapse of 2001, 407

Double quotes, strings enclosed within, 304

Downloads, 502

Drivers, 336

DSL. *See* Digital subscriber line

DSM. *See* *Diagnostic and Statistical Manual of Mental Disorders*

DTD. *See* Document Type Definition

Dual-boot system, 330–331

Dual layer, 138

Duchamp, Marcel, 8, 8*f*

Dumb terminal, 335

DVD. *See* Digital versatile disk

Dvorak, John C., 26

Dynamic-partition technique, 340

Dynamic systems, 454

## E

e-commerce, 388, 407–408

E-Rate Program, 30

E-vote glitch, 138

eBay, 407

Eckert, J. Presper, 126, 127

Eckert-Mauchly Computer Corporation, 46

*Economist, The*, 601

Edge, 24  
 in graphs, 256, 257*f*

EDVAC computer, 11

Effective weight, 433, 434

802.11 (wireless networking support) standard, 124  
 versions 802.11ac, 543

EIM. *See* Employee Internet monitoring

Einstein, Albert, 83

Electrical signal, 102

Electricity, 94

Electro-mechanical tabulator, 10

Electronic commerce (e-commerce), 388, 407–408

Electronic health records, 352–353

Electronic signals, 58

Electronic spreadsheets, 388

Electronic voting system, 138

ELEMENT tags, in DTD documents, 544

ELIZA, 442

Ellis Island website, 388

- email, 3
    - opt-in or opt-out and marketing, 380
  - Embedded systems, 25, 141–142
  - Emergency action notification, 254
  - Emitter, transistor, 102
  - Employee Internet monitoring (EIM), 273
  - Employee record, 208*f*
  - emWave, 375
  - Encapsulation, 285, 313–314
  - Encryption, 569
    - .END pseudo-op, 165
  - Endangered species, managing, 153
  - eNeighbor system, 376
  - Engelbart, Doug, 503*b*
  - ENIAC machine, 11, 12, 12*f*, 127
  - Enigma cipher, 576
  - Entities, in discrete-event models, 456
  - Entity-relationship (ER) modeling, 406
  - EPAM, 424
  - Epic Game's Unreal Script for the Unreal Engine, 486
  - ePolicy Institute, 273
  - Equal sign (=), 392
  - Equal to relational operator, 300*t*
  - ER diagrams, 406
  - ER modeling. *See* Entity-relationship modeling
  - Erasing data in file, 366
  - Erosion models, 474
  - Error-correcting code, 596
  - Error-detecting code, 595
  - Errors, 602–604
    - in government projects, 603–604
    - maintenance project and, 600*t*
  - Escape character, 72
  - ETA model, 464
  - Ethernet, 17, 505
    - cable, 125
  - Ethical issues
    - ACM Code of Ethics, 115
    - blogging, 580–581
    - computing limitations, 620
    - digital divide, 30
    - effects of social networking, 519
    - FISA Court, 49
    - gambling, 551–552
    - gaming as an addiction, 489–490
    - HIPAA, 352–353
    - hoaxes and scams, 321–322
    - IEEE Code of Ethics, 114
    - initial public offerings, 447
    - Internet and politics, 411–412
    - Internet gambling, 551–552
    - journalism, 580–581
    - medical privacy, 352–353
    - open-source software, 232–233
    - politics, 411–412
    - privacy, 146, 352–353, 380
    - software piracy, 185
    - spam and email marketing, 380
    - surveillance, 49, 86
    - Therac-25, 620
    - workplace monitoring, 273–274
  - Euclid, 39
  - European Space Agency, rocket software error, 604
  - European Union, 380
  - Even parity, 595
  - Event-controlled loops, 201–203
  - Event-driven processing, 313
  - Events, in discrete-event models, 456
  - Excited state, neurons in, 432
  - Execution units, 142
  - Expert systems, 423, 430–432
  - Exponential time, 610
  - Extensible Markup Language (XML), 544
  - Extensible Stylesheet Language (XSL), 546
  - EZPass, 365
- ## F
- Facebook, 331, 447, 519, 547, 574
    - initial public offering, 447
    - presidential elections and, 411
    - privacy and, 380
    - protecting information on, 572
  - Factorial time, 611

- False value, in Boolean data type, 303
- Family laundry analogy, 609
- Feigenbaum, E. A., 424
- Fetch–execute cycle, 134*f*, 161
  - decoding instruction, 133
  - executing instruction, 133–134
  - fetching next instruction, 132–133
  - getting data, 133
- Fiedler, Edna, 160
- Fields (or attributes), 283, 400
- Fifth Estate, The* (movie), 578
- Fifth-generation software, 23–25
- Fighting games, 483
- File access, 366–367
  - direct, 367
  - sequential, 366
- File extensions, 363–364
- File operations, 365–366
- File protection, 367–368
- File servers, 18, 497
- File systems, 362–368
  - defined, 362
  - file access, 366–367
  - file operations, 365–366
  - file protection, 367–368
  - file servers, 18, 497
  - file types, 363–364
  - reading, 365
  - text and binary files, 362–363
- File Transfer Protocol (FTP), 507
- File types, 363–364
- Filtering, 283, 284, 286
  - example, 286–289
- Fingerprint analysis, 564–565, 565*f*
- Firefox, 24, 331, 533*f*
- Firewalls, 509–510, 509*f*
- First Amendment protection of bloggers, 580
- First-come, first-served (FCFS) scheduling approach, 347–348, 375
- First fit, 341
- First-generation software, 13
- First-in, first-out (FIFO) behavior, 243, 244, 457
- FISA. *See* Foreign Intelligence Surveillance Act
- Fixed-partition technique, 340
- Fixed robots, 440
- Fixed-sized numbers, 62–63
- Flag character, 74–75
- Flash drives, 139
- Flash images, 84
- Flash memory, 139, 139*f*
- Flight graph, data for, 258*t*
- Floating point, 66, 66*t*, 67*t*
- Floppy disks, 137, 139
- Flowers, Thomas, 11
- Fonts, for data cells in spreadsheets, 391
- Ford Tri-Motor of computers. *See* IBM 650
- Forecasting models, 463–464
- Foreign Intelligence Surveillance Act (FISA), 49, 86
  - FISA Amendments Act of 2008, 49
  - FISA Amendments Act Reauthorization Act of 2012, 49
  - FISA Court, 49, 86
- Formal verification, of program correctness, 600–601
- Formulas, spreadsheets, 391–394
- FORTTRAN, 20, 72, 248, 293, 295
- FORTTRANSIT, 72
- Forward slashes
  - absolute paths in UNIX system and use of, 372
  - comments prefaced with, 201
  - root in UNIX environment designated with, 371
- Four-level binary search tree, 252*f*
- Fourth-generation computer hardware/software, 16–17, 23
- Fractal models, 474
- Frame, 342
- Franksten, Bob, 395
- Free Software Foundation, 232–233
- From clause, 404
- Front-side bus (FSB), 122–123
- FSB. *See* Front-side bus
- FTP. *See* File Transfer Protocol
- Full adder, 109, 109*f*
- Functional model, 296–297

**G**

- Gambling on Internet, 551–552
- Game engine, defined, 484
- Game loop, 487
- Game play, 489
  - defined, 483
- Games and gaming, 482–487
  - as addiction, 489–490
  - dangers of, 516
  - defined, 482
  - design and development of, 485–486
  - history of, 483
  - programming, 486–487
  - virtual world, 483
- Gantt charts
  - first come, first served, 347
  - round robin scheduling algorithm, 350*f*
  - shortest job next, 348
- Gantz, John, 185
- Gates, 5, 94
  - AND gate, 97–98, 97*f*, 103–104
  - and circuits, 93–116
  - combinational circuits and, 104
  - constructing, 101–104, 103*f*
    - transistors, 102–104
  - gate processing review, 100–101
  - logic, 96
  - with more inputs, 101
  - NAND and NOR gates, 99–100, 103
  - NOT gate, 96–97, 96*f*
  - OR gate, 98, 98*f*
  - review of processing, 100–101
  - XOR gate, 98–99, 99*f*
- Gates, Bill, 508
- Gateway, 498
  - between LAN and other networks, 498
- Gateway 2000, 594
- General case
  - in recursive algorithm, 221
  - for recursive factorial, 223
- General Public License (GPL), 232, 233
- Genomics, computational, 467
- Geometric modeling techniques, 468, 469*f*
- Geophysical and Fluid Dynamics Laboratory (GFDL), 465
- The George Polya Prize, 195
- German Enigma and Lorenz ciphers, 576
  - image file, 364
- GFDL. *See* Geophysical and Fluid Dynamics Laboratory
- GIF. *See* Graphics Interchange Format
- Giga, 145
- GIMPS project. *See* Great Internet Mersenne Prime Search project
- Glaser, Will, 172
- Global impact, 27*t*
- Goldstine, Herbert, 248
- Google, 331, 380
  - Chrome, 24
- Google Analytics, 530–531, 531*f*
- Google Cloud, 516
- Google spider bots, 528
- Government projects, bugs in, 603–604
- GPL. *See* General Public License
- GPU. *See* Graphics processor unit
- Grace Murray Hopper Award, 395
- Grade point average, calculating, 285
- Graph algorithms, 259–265
  - breadth-first search, 261–264
  - depth-first search, 259–261, 260*f*
  - single-source shortest-path search, 264–265
- Graph theory, 250
- Graphical user interface (GUI), 312, 364, 462, 468
- Graphics and images, 80–84
  - color, 80–82
  - digitized images, 82–83
  - vector representation of graphics, 83–84
- Graphics Interchange Format (GIF), 83
  - .gif extension, 364, 364*f*
- Graphics processor unit (GPU), 123
- Graphs, 256–265
  - creating, 258–259
  - defined, 256
  - directed, 256
  - examples of, 257*f*



- undirected, 256
  - vertices and edges in, 256
  - Great Internet Mersenne Prime Search (GIMPS) project, 39
  - Greater than or equal to relational operator, 300*t*
  - Greater than relational operator, 300*t*
  - Green trends, 529
  - Grid lines, in spreadsheets, 391
  - Grounded electrical signal, transistors and, 102
  - Group permissions, in UNIX operating system, 367
  - Growth rates, comparison of, 611*t*
  - GUI. *See* Graphical user interface
  - Gulf War I, missile software errors during, 603–604
- H**
- Hackers, 146, 267
  - Half adder, 108
  - Halting problem, 615–617
    - proposed program for solving, 615–616, 616*f*
  - Haptics, 470
  - Hard disks, 136*f*, 137
  - Hardware, 3, 4, 5
    - cloud computing, 18–19
    - in computing system, 4
    - early history, 9–13
    - first generation (1951–1959), 13
    - fourth generation (1971–?), 16–17
    - limits caused by, 588–596
    - networking, 17–18
    - parallel computing, 17
    - second generation (1959–1965), 13
    - third generation (1965–1971), 15–16
  - Hardware layer, 5
  - Harris Interactive Poll, 489
  - Harvard Mark I computer, 11, 46
  - Hashing, 38
  - HD. *See* High definition
  - HDMI. *See* High-definition multimedia interface
  - Head-mounted display (HMD), 462
  - Health Insurance Portability and Accountability Act (HIPAA), 352–353
  - Heart rate variability, 375
  - Heartbleed bug, 602
  - HeartMath, 375
  - Hertz, Heinrich R., 122
  - Hertz (Hz), 122
  - Heuristics, 567
  - Hewlett-Packard, 16, 18
  - Hexadecimal number, 38–41
  - High color, 80
  - High definition (HD), 123
  - High-definition multimedia interface (HDMI), 125
  - High-level languages, 20, 291
    - functionality in, 298–313
      - Boolean expressions, 299–301
      - control structures, 307–310
      - data typing, 301–305
      - input/output structures, 305–307
  - High-level protocols, 506, 507–508
  - High-speed digital cameras, 282
  - HIPAA. *See* Health Insurance Portability and Accountability Act
  - History of Modern Computing, A* (book), 18
  - Hoare, C. A. R., 224, 601
  - Hoare, Tony, 377–378
  - Hoaxes, 321–322
  - Hollerith cards, 13, 130
  - Hollerith, Herman, 10–11, 130
  - Home monitoring sensors, 376, 393
  - Hopper, Grace Murray, 46*b*, 125
  - Host. *See* Nodes
  - Host table, 514
  - Hostnames, 510
  - Houses relationship, 425
  - How to Solve It: A New Aspect of Mathematical Method* (book), 192, 195
  - HTML. *See* Hypertext Markup Language
  - HTML5, 532, 540–541
  - HTTP. *See* Hypertext Transfer Protocol
  - Huffman, David, 75
  - Huffman encoding, 75–77
  - Hurricane tracking, 464–466, 465*f*
  - Huynh, Justin, 247
  - HWRE, 465

- Hybrid cloud, 516
  - Hybrid deliberate/reactive approach, 443
  - Hypermedia, 531
  - Hypertext, 531
  - Hypertext Markup Language (HTML), 24, 508, 531–541, 534*f*
    - elements, 535
    - tag attributes, 534–535
    - tags, 532, 535
  - Hypertext Transfer Protocol (HTTP), 507
- I**
- IBM
    - cards, 13
    - Deep Blue, 158
    - founding of, 11, 130
    - IBM 370/168, 16, 404, 594
    - IBM Automatic Sequence Controlled Calculator, 11
    - Journal of Research and Development*, 603
    - PC, 16, 395
  - IBM 650, 41, 69
  - ICANN, 513, 514
  - ICs. *See* Integrated circuits
  - ICT Development Index (IDI), 30
  - Identifiers, 230, 315
    - in assembly language, 301
    - uppercase and lowercase used in, 305
  - Identity property, 107*t*
  - Identity theft, 321
  - IDI. *See* ICT Development Index
  - IE. *See* Internet Explorer
  - IEEE. *See* Institute of Electrical and Electronics Engineers
  - IF function, in spreadsheets, 394*f*
  - If statement, 308
  - If-then-else statement, 181
  - Ifrah, Georges, 37
  - Illumination model, 473
  - IM. *See* Instant messaging
  - iMac, 349
  - Images/graphics, 527
    - digitized, 82–83
    - representing color, 80–82
    - vector representation of graphics, 83–84
  - Imitation Game, The* (movie), 11
  - Immediate addressing mode, 155
  - Immigration database, 388
  - Imperative paradigm
    - object-oriented, 295–296
    - procedural, 295
  - Implementation level, 242
    - in computer problem-solving process, 196, 196*f*
  - Inclusive OR gate, 99
  - Indentation, in Python, 308
  - Indexed color, 83
  - Indexing techniques, search engines and, 528
  - Inference engine, 430
  - Infinite loop, 201
  - Infinite recursion, 223
  - Informatics, 26
  - Information, 5, 56, 388
  - Information Age, 30
  - Information hiding, 8, 228–229, 313
  - Information layer, 5
  - Information management, 388–389
  - Information security, 558–560
  - Information Superhighway, 18
  - Information systems, 5, 387–412
    - and big data, 409
  - Infrared touch screen, 141
  - Inheritance, 316–317
  - Inhibited state, neuron in, 432
  - Initial public offerings, 447
  - Input devices, 13
  - Input, in pseudocode algorithm, 172
  - Input statements, in four languages, 307
  - Input stream, 306
  - Input unit, 130
  - Input/output devices, 15, 130
  - Insertion sort algorithm, 220, 220*f*
    - insert statement, in SQL, 405
  - Insertions, spreadsheet formulas and, 393
  - Inspection, 599



- Instagram, 519
  - Instance, 282
  - Instance-of relationships, 425
  - Instant messaging (IM), 528–529
  - Instantiation, 315, 425
  - Institute of Electrical and Electronics Engineers (IEEE), 124
    - Codes of Ethics, 114
  - Instruction-level parallelism, 142, 144
  - Instruction register (IR), 131
    - in Pep/9, 154
    - simulation program, 161
  - Instruction specifier, in Pep/9, 155
  - Integers, 36, 302
    - limits on, 588–589
    - sorted list of, 246f
    - unsorted list of, 245f
  - Integrated circuits (ICs), 15, 112
  - Integrity, 559
  - Intel, 15, 170
  - Intelligent browsers, 26
  - Interactive systems, 454
  - Interactive web pages, 541–543
  - International Species Inventory System (ISIS), 153
  - Internet, 6, 18, 27*t*, 396, 506. *See also* Web (World Wide Web)
    - access, 30
    - connections, 500–502
    - control of, 514–515
    - digital divide and, 30
    - lending clubs, 260
    - privacy issues, 380
    - shopping, 407–408
    - spying, 86
    - stock sales, 447
    - surveillance on, 86
  - Internet backbone, 500
  - Internet Explorer (IE), 24
  - Internet gambling, 551–552
    - software piracy and copyrighting, 185
  - Internet gaming disorder*, 490
  - Internet Protocol (IP), 506
    - address, 510–511, 511f
  - Internet service providers (ISPs), 500, 514–515, 526
    - privacy and spam, 380
  - Internetworking, 498
  - Interoperability, 504
  - Interpreters, 292–294
  - Intersection operation, in SQL, 405
  - Intractable problems, 617
  - Inventory control systems, 330
  - Inversion bubble, 97
  - Inverter, 96
  - Investigation of the Laws of Thought; on Which Are Founded the Mathematical Theories of Logic and Probabilities, An* (book), 95
  - iOS mobile operating system, 331
  - IP. *See* Internet Protocol
  - iPad, 331
  - iPhone, 331, 331*f*, 565, 574
  - iPod, 348
  - iPod Touch, 331
  - IR. *See* Instruction register
  - ISBLANK function, in spreadsheets, 394*f*
  - ISIS. *See* International Species Inventory System
  - ISPs. *See* Internet service providers
  - Item number, in Universal Product Code, 402
- J**
- Jacquard, Joseph, 9
  - Jacquard's loom, 9
  - Java, 24, 293, 296, 301
    - asynchronous processing in, 313
    - braces in, 308
    - class concept and, 313
    - if and while statements in, 308
    - input statement in, 307
    - variable declaration in, 304
  - Java applets, 541–542
  - Java Bytecode, 542
  - .java extension, 364, 364*f*
  - Java Model Railroad Interface, 233
  - Java program compiled into, and run on different systems, 294*f*

Java Server Pages (JSPs), 542–543  
 scriptlets, 542  
 Java Virtual Machine (JVM), 293  
 JavaScript, in game development, 486  
 Job, 333  
 Jobs, Steve, 16, 349*b*  
 Journalism protection of bloggers, 580  
 JPEG format, 82, 83, 363  
 JSPs. *See* Java Server Pages  
 JVM. *See* Java Virtual Machine

## K

Kasparov, Garry, 429  
 Katzer, Matthew, 233  
 Kennedy–Nixon debate, 427  
 Kerry–Bush election, 138  
 Key fields, 400  
 Keyboard, 16  
 Keyframe, 85  
 Keyword encoding, 71–74  
 Keyword stuffing, 528  
 Keywords, 549  
 Knowledge-based system, 430  
 Knowledge representation, 423–429  
   defined, 423  
   search trees, 427–429  
   semantic networks, 425–427  
 Knowledge responsibilities, 285  
 Knox, Dilly, 576  
 Kuhn, Thomas, 295

## L

Labels, 168  
 Lambda calculus, 615  
 Landscape, computer-generated, 475*f*  
 LANs. *See* Local-area networks  
 Laptop computers  
   hard disks, 137  
   translating advertisement for, 122–126

Lardner, Dionysius, 14  
 Large-scale integration, 16, 112*t*  
 Last-in, first-out (LIFO), 242, 243  
 Latency, 137, 374, 500  
 Latin-1 Extended ASCII character set, 69  
 Leaf node, 249  
 LED. *See* Light-emitting diode  
 Lee, J. A. N., 594  
 Left child, in binary trees, 247  
 LEFT function, in spreadsheets, 394*f*  
 Leibniz machine, 9  
 Lending clubs, 260  
 Less than or equal to relational operator, 300*t*  
 Less than relational operator, 300*t*  
 Leveson, Nancy, 597  
 Lexical ambiguity, 439  
 Library class, 288–289  
 Licensing, of computer professionals, 180  
 Life-simulation games, 483  
 Light  
   normal view and reflection vectors, 471, 471*f*  
   simulating, 472–474  
   works, 470–472  
 Light-emitting diode (LED), 123  
 Lightweight laptops, 125  
 Like operation, in SQL, 405  
 Limitations on computing, 6, 587–620  
   ethical issues, 620  
   hardware, 588–596  
     limits on arithmetic, 588–593  
     limits on communication, 595–596  
     limits on components, 594  
   problems, 604–618  
     Big-O analysis, 607–610  
     classification of algorithms, 617–618  
     comparing algorithms, 605–612  
     halting problem, 615–617  
     Turing machines, 612–615, 615*f*  
   software, 596–604  
     complexity of software, 596–597  
     notorious software errors, 602–604  
*Limits of Computing, The* (book), 588, 603  
 Lincoln, Abraham, 427

Linear accelerators, 620  
 Linear time, 610  
 Lines, 362  
 Linked structure, 245  
 LinkedIn, 519  
 Linkers, 21  
 Links, 250, 526  
 Linux, 5, 185, 233, 331, 601  
 Lisp language, 20, 293, 296, 298, 431  
 List data structure and subprograms, in object-oriented design, 318–319  
 Lists, 244–247, 258  
 Lively (monitoring product), 393  
 Lives-in relationships, 425  
 Loaders, 21, 161  
 Local-area networks (LANs), 18, 497, 498f  
 Loebner, Hugh, 422  
 Loebner prize, 423  
 Logarithmic time, 610  
 Logic bomb, 566  
 Logic diagram, 94  
     of circuit, 104  
 Logic gates, 96  
 Logic programming, 297–298  
 Logic Theorist, 424  
 Logical address, 337, 338–339  
     binding of, to physical address, 339f  
     invalid, 343  
     in paged memory management system, 343  
 Logical (or abstract) level, 242  
 Login process, 335  
 LOOK disk scheduling, 378  
 Loop control variable, 200  
 Looping, 298  
     selection statements nested within structures of, 310  
 Loops  
     count-controlled, 200–201  
     event-controlled, 201–203  
     halting problem and, 615–617  
     history behind, 10  
     infinite, 201

    pretest, 201  
     program with, 170  
 Lorenz cipher, 576  
 Lossless compression, 57  
 Lossy compression, 57  
 Lotus, 23  
 Lotus 1-2-3, 395  
 Lovelace, Ada (Countess of Lovelace), 9

## M

Mac OS family, 5, 331  
 Machine code, 191  
 Machine language, 16, 19, 152–159  
     first-generation software, 19–20, 20f  
     program example, 159–163  
     second-generation software, 20–21, 21f  
     third-generation software, 21–23, 22f  
 Machine translation, unrealized early promise of, 439  
 Macintosh, 23  
 Magnetic cores, 13  
 Magnetic disks, 15, 136–137, 136f, 363, 373, 374f  
 Magnetic drum, 13  
 Magnetic tape, 13, 135, 135f  
 Main memory, 123, 336  
     partition memory management and, 340  
     sections of, 338f  
 Main module, 197  
 Main tasks, listing, algorithm design and, 197–198  
 Mainframe, 335  
 Maintenance phase  
     in computer problem-solving process, 196, 196f  
     errors found during, 600, 600t  
 Malware (malicious code), 208, 565–566  
     detection software, 125  
 MAN. *See* Metropolitan-area network  
 Man-in-the-middle, 569  
 Mantissa, binary floating-point value and, 66–67  
 Manufacturer identification number, in Universal Product Code, 402  
 Many-to-many relationship, 406

- Mariner 1 (Venus probe) error, 604
- Markup language, 532, 532*f*, 547. *See also* Hypertext Markup Language
- Mars Climate Orbiter Mission Failure, 604
- Mars Reconnaissance Orbiter, 443
- Mass storage devices, 135
- Massachusetts Institute of Technology (MIT), 30, 395, 538
- Massively parallel processor, 144
- Mathematical Analysis of Logic, The* (book), 95
- Mathematical logic, 27
- Mathematics and Plausible Reasoning* (book), 195
- Mathematics education, 195
- Mauchly, John, 126, 127
- MAX function, in spreadsheets, 394*f*
- MB (megabytes), 123
- McAfee, 567
- Medical diagnosis applications, 26
- Medical records, privacy issues and, 352–353
- Medium-scale integration circuit, 112*t*
- Megabyte, 123
- Memory, 128–129
  - address, 336
  - circuits as, 111
  - management of, 332, 336–344
    - paged, 341–344
    - partition, 339–341
    - single contiguous, 338–339
  - transistors, 16
- Memory-mapped I/O, 159
- Menabrea, Luigi, 14
- Mercury thermometer, as analog device, 57–58, 58*f*
- Metadata, 83, 86
- Metalanguage, 544
- Metcalfe, Robert, 17
- Meteorological models, 461–466, 461*f*
  - hurricane tracking, 464–466, 465*f*
  - weather forecasting, 463–464
- Method (algorithm), 283
- Metrics, scheduling algorithms evaluation and, 346
- Metropolitan-area network (MAN), 498
- Micro-taggant, 606
- Microcomputers, 16, 335
- Microphones, 125
- Microseconds, 125
- Microsoft Research (England), 378
- Microsoft®, 23, 185, 508
  - Azure, 516
  - Excel spreadsheet program, 389
  - Internet Explorer (IE), 24
  - open-source software debate and, 232, 233
  - Windows, versions of, 331
  - Word, 23, 69, 363
- Midpoint sub-division, 476, 476*f*
- Miller's law, 7
- MIMD computers. *See* Multiple-instruction, multiple-data-stream computers
- MIME. *See* Multipurpose Internet Mail Extension
- Minicomputers, 335
- Missile guidance programs, 330
- MIT. *See* Massachusetts Institute of Technology
- ML language, 296
- Mnemonic letter codes, assembly languages and assignment of, 163
- Mobile devices, in classroom, 244. *See also* iPhone; Laptop computers; Smartphones
- Mobile robots, 440
- Model Output Statistics (MOS) model, 464
- Models, 455
  - constructing, 455–457
- Modem, 500
- Modula-2, 23
- Modulus operator, 302
- Molecular modeling, 467
- Moore, Gordon, 15
- Moore's law, 15, 17
- MOS model. *See* Model Output Statistics model
- Mosaic, 24
- Motherboard, 131
- Mouse, 23, 503
- Mouse clicking, 23, 313
- Mozilla Firefox, 24
- MP3 audio format, 79–80
- MS-DOS, 23
- Multi-boot system, 330–331
- Multicore processors, 144

- Multimedia, 56
- Multiple-instruction, multiple-data-stream (MIMD) computers, 17
- Multiplexers, 110–111
- Multiplication, of integers, 302
- Multiprogramming, 332
- Multipurpose Internet Mail Extension (MIME), 508–509
- Music Genome Project, 172, 177
- Music streaming, 177
  
- N**
- $N \log_2 N$  time, 610
- Name class, in responsibility algorithm, 290–291
- Naming things, 230–231
- NAND gate, 99–100, 99f
  - memory circuits and, 111
  - SSI chip containing, 112f
  - transistors and, 103, 103f
- Nanoscience, 96
- Nanoseconds, 125
- Nanotube transistors, 16
- NASA twin robot launch, 444
- National Medal of Technology, 127
- National Oceanic and Atmospheric Administration (NOAA), 464
- National Security Agency (NSA), 49, 86, 140, 462, 514
- National Weather Service, 465
- Natural join operation, in SQL, 405
- Natural language comprehension, 435, 436, 439–440
- Natural language processing, 435–440
  - defined, 423
  - natural language comprehension, 439–440
  - voice recognition, 436, 438–439
  - voice synthesis, 436, 437–438
- Natural number, 36
- NCR, 16
- Negative number, 36
- Negative values, 61–65
  - fixed-sized numbers, 62–63
  - number overflow, 65
  - signed-magnitude representation, 61–62
  - two's complement, 64–65
- Negroponte, Nicholas, 30
- Neiman Marcus (retailer), 146
- Nested directories, 369
- Nested Grid model (NGM), 464
- Nested logic, 310–312
- Nested structure, 203
- Netscape Navigator, 24, 331
- Netware (Novell), 18
- Network addresses, 510–511
- Network neutrality, 515
- Network protocols, 505–506, 505f
- Networked workstations, 16
- Networking, 17–18. *See also* Social networks over social media, 519
- Networks, 6, 336, 495–518. *See also* Social networking
  - types of, 498f
- Neural networks, 432–435
  - artificial, 433–435
  - biological, 432–433, 433f
  - defined, 423
- Neurons, 432
- New state, 344
- Newell, Allen, 424
- Newman, Max, 614
- Newspapers, 529
- NeXT, 349
- NGM. *See* Nested Grid model
- Nigerian check scams, 160
- Nike sensor, 348
- Nim, search trees for simplified version of, 427–428, 428f
- Nintendo, 483, 487
- Nixon–Kennedy debate, 427
- NOAA. *See* National Oceanic and Atmospheric Administration

- Nodes, 245, 496
    - in binary search trees, 247, 249, 250
    - graph theory, 250
  - Nonpreemptive scheduling, 346
  - NOR gates, 99–100
    - transistors and, 103, 103f
  - Norton, 567
  - Norwegian Computing Center, 458
  - NOT Boolean operator, 107, 209, 301
  - Not equal to relational operator, 300*t*
  - NOT expression, 97
  - NOT gates, 96–97, 96f, 100
    - transistors and, 103, 103f
  - Notes on Structured Programming* (article), 307
  - Nouns, in object-oriented design, 286
  - NP-complete problems, 618
  - NSA. *See* National Security Agency
  - Nude Descending a Staircase* (painting), 8f
  - Numbers. *See also specific entries*
    - and binary values, 35–49
      - numbers and computing, 36
      - positional notation, 36–47
    - categories of, 36
    - and computing, 36
    - overflow, 65
  - Numeric data, 61–68
    - negative values, 61–65
      - fixed-sized numbers, 62–63
      - number overflow, 65
      - signed-magnitude representation, 61–62
      - two's complement, 64–65
    - real numbers, 65–68
  - Numeric values, 61
  - Nygaard, Kristen, 458
- O**
- Obama, Barack
    - Internet election strategy of, 411–412
    - on NSA eavesdropping, 86
  - Object class, 282, 314
  - Object orientation, 282–283
  - Object-oriented design, 24, 198, 224, 282, 290
    - nouns in, 286
    - procedural design compared with, 318–319
    - top-down design *vs.*, 282
  - Object-oriented languages
    - classes, 314–316
    - functionality of, 313–318
      - encapsulation, 313–314
    - inheritance, 316–317
    - polymorphism, 317–318
  - Object-oriented methodology, 282–291
    - design methodology, 283–286
      - brainstorming, 283–284
    - example
      - brainstorming and filtering, 286–289
      - problem statement, 286
      - responsibility algorithms, 289–291
    - filtering, 286
      - responsibility algorithms, 285–286
      - scenarios, 284–285
    - object orientation, 282–283
  - Object-oriented paradigm, 295–296
  - Objects, 282
    - being served, in queuing model, 458
    - as implementation phase, 314
    - matter shaped by, 472
    - shadows and, 471
  - Octal number, 38–41
  - Odd parity, 595
  - Office suites, 24
  - Offset value, 343
  - OLPC computers. *See* One Laptop per Child computers
  - Olsen, Ken, 25
  - 1-bit binary adder, 11
  - One Laptop per Child (OLPC) program, 30
  - One-to-many relationship, 406
  - One-to-one relationship, 406
  - Online blogging, 24
  - Online gambling, 551–552
  - Online transactions, future of, 516
  - Open Handset Alliance, 331
  - Open Source Hardware Bank, 247



- Open-source software, 185, 232–233, 601–602
  - Open systems, 504
  - Open Systems Interconnection (OSI) Reference Model, 504, 505*f*
  - Operand specifier, in Pep/9, 155
  - Operating system(s), 5, 21, 329–353
    - batch processing, 333–334
    - in computing system, 5
    - CPU scheduling and, 345–350
    - defined, 332
    - factors related to, 335–336
    - first-come, first-served and, 347–348
    - interactions of, 330*f*
    - main memory and, 336, 337, 338*f*
    - memory management and, 336
    - memory, process, and CPU management, 332–333
    - path names and, 371–373
    - process control block, 345–346
    - process states, 344–345
    - round robin CPU scheduling and, 356–358
    - roles of, 330–336, 330*f*
    - secondary memory tracked by, 365
    - timesharing, 334–335
  - Operation codes (opcodes), in Pep/9, 155
  - Operator, 333, 333*f*, 335
  - Opt-in and opt-out, 380
  - OR Boolean operator, 106, 209, 301
  - OR gate, 98, 98*f*, 100
    - combinational circuit and, 104
  - Order of magnitude, 607–610
  - Orzack, Maressa Hecht, 489
  - OS. *See* Operating system(s)
  - OSI Reference Model. *See* Open Systems Interconnection Reference Model
  - Output devices, 13
  - Output, in pseudocode algorithm, 172
  - Output statements, 306
  - Output unit, 130
  - Overflow, 65, 593
  - Owner permissions, in UNIX operating system, 367
- p**
- p-code, 293
  - P2P model. *See* Peer-to-peer model
  - Pacific Marine Environmental Laboratory, 464
  - Packet switching, 18, 502–504
  - Packets, 502
  - Page-map table (PMT), 342
  - Page number value, 343
  - Page swap, 343
  - Paged memory management, 338, 341–344
  - Paged memory technique, 342, 342*f*
  - Paging, memory management with, 343
  - Paint programs, 469
  - Pandora, 177
  - Paradigms
    - declarative, 296–297
    - defined, 295
    - imperative, 295
  - Parallel architectures, 17, 142–145
    - classes of parallel hardware, 144–145
    - parallel computing, 142–144
  - Parallel computing, 17, 142–144
  - Parallel hardware, classes of, 144–145
  - Parameters, 266–267
    - lists, 266
    - passing by reference, 268
    - passing by value, 268
    - positional, 267
  - Parent directory, 369
  - Parentheses, objects within, 298
  - Pareto's law, 456
  - Parity bits, 595
  - Partition memory management, 339–341
    - address resolution in, 340, 340*f*
  - Partition selection, approaches to, 341
  - Partition table, 341
  - Pascal, Blaise, 9
  - Pascal language, 23, 293, 295
  - Passwords, 561–563
    - guessing, 567
    - management software, 563
  - Path, 257

- Path names, 371–373
- Paul, Ron, 411
- PayPal, 260, 407
- PC-DOS, 23
- PC Magazine*, 26
- PCB. *See* Process control block
- PCM. *See* Pulse-code modulation
- PCs. *See* Personal computers
- Peer-to-peer (P2P) model, 288, 497
- Pentium chip, 594
- Pep/9 (virtual computer), 153–159
  - architecture, 154*f*
  - assembly, 164–166
    - program with a loop, 170
  - basic features of, 153–155
  - immediate addressing mode and direct addressing mode, 155, 156*f*
  - important features reflected in, 153
  - instruction format, 155, 155*f*
  - instruction of Stop in, 302
  - limits on, 588
  - sample instructions, 156–159
    - add operand to A register, 158
    - load byte into A register, 157
    - load word into A register, 156–157
    - stop execution, 156
    - store byte from A register, 158
    - store word from A register, 158
    - subtract operand from A register, 159
  - simulator, 160–162
  - subset of instructions, 156*f*
- Period, statements of fact ended with, 298
- Peripheral devices, 13
- Perlis, Alan, 133
- Person class, in responsibility algorithm, 289
- Personal computers (PCs), 16, 335
- Personal identification number (PIN), 132, 560
- Personal privacy, 146
- Philosophy and computer programming, 311
- Phishing, 567–568
- Phone-answering competition, 79
- Phone data, 86
- Phone modems, 500–501
- Phonemes, 437, 437*f*
- Photographs, 82, 82*f*
- Physical address, 337, 337*f*
  - logical address bound to, 340, 340*f*
  - producing, 341
- Physics engine, 484
- PI function, in spreadsheets, 394*f*
- Picoseconds, 125
- Picture elements. *See* Pixels
- Piggybacking, 218
- PIN. *See* Personal identification number
- Ping, 506
- Pipeline, processors in, 143*f*
- Pipelining technique, 131
- Pirated software, 185, 208, 288, 317
- Pixar, 349
- Pixels, 82, 468, 473
- Plankalkul* (Plan Calculus), 181
- Planning systems, robotics and, 441
- Plato, 224
- Platters, 137
- Playstation, 487
- PMT. *See* Page-map table
- PNG. *See* Portable Network Graphics
- Point-and-click, 23
- Polya, George, 192, 193, 195*b*, 198
- Polya's list, 192*f*, 193
- Polymorphism, 317–318
- Polynomial-time algorithms, 611
- Polynomials, 37
- Pong, 483
- Popping items, off stack, 243
- Popular Mechanics, 25
- Portability, standardized languages vs. interpretation
  - by Bytecode, 294*f*
- Portable devices, security of, 574–575
- Portable Network Graphics (PNG), 83
- Ports, 125, 508
- Positional notation, 36–47
  - arithmetic in other bases, 41–42
  - binary, octal, and hexadecimal, 38–41
  - binary values and computers, 45–47



- converting from base 10 to other bases, 44–45
  - power-of-2 number systems, 42–44
- Pound sign (#), at beginning of comment in Python, 304–305
- Power of 2 number systems, 42–43
- Pratt, Terry, 293
- Precision, 590
- Preemptive scheduling, 345
- Prefixes, used in computing, 126
- Prentice Hall, 25
- Presidential campaigns
  - electronic voting in, 138
  - Internet and, 411–412
  - social networking and, 411–412
- Pretest loop, 201
- Preventive maintenance, 594
- Prime number, largest, 39
- Princeton Ocean Model, 465
- Printing, data in binary search tree, 254–255, 255*t*
- Priority queue, 265, 460
- Privacy, 146
  - electronic health records, 352–353
  - expense of, 591
  - workplace, 273–274
- Private cloud, 516
- Private fields, in class, 316
- Probabilistic models, 475–476
- Problem solving, 5, 192–199
  - algorithms, 194
  - computer problem-solving process, 196
  - divide and conquer, 194
  - look for familiar things, 193
  - questions to ask, 193
  - summary of methodology, 196–198
    - analyzing problem, 197
    - list main tasks, 197–198
    - re-sequence and revise as necessary, 198
    - write remaining modules, 198
  - testing algorithm, 198
- Problems
  - equally valid solutions to, 605, 605*f*
  - halting problem, 615–617
- Procedural abstraction, 230
- Procedural design, object-oriented design compared with, 318–319
- Procedural programming, 295
- Process, 332
- Process control block (PCB), 345
- Process life cycle, 344*f*
- Process management, 332
- Process states, 344–345
- Processing algorithms with arrays, 207
- Processors, 122
- Program counter (PC), 131, 132
  - in Pep/9, 154
  - simulation program, 161
- Programming, 3, 27*t*
  - in computing system, 5
  - game, 486–487
  - layer, 5
  - object-oriented, 24
  - skill, 26
  - structured, 24, 307, 309
- Programming language paradigms
  - declarative paradigm, 296–298
  - imperative paradigm, 295–296
- Programming Research Group, 377
- Project operation, in SQL, 405
- PROLOG (logic programming language), 297, 298
- Proprietary systems, 504
- Protein structure prediction, 467
- Protocols, 496
  - defined, 505
  - high-level, 507–508
  - network, 505–506
  - open systems and, 504–510
  - ports used by, 508
  - stack, 505
  - TCP/IP, 506–507
- Pseudo-operations, 165
- Pseudocode, 171, 191, 281
  - algorithm
    - following, 175–177
    - translating, 180–182
    - writing, 177–180
  - elements, 174*t*
  - functionality

- assignment, 171–172
    - input/output, 172
    - repetition, 173–175
    - selection, 172
    - variables, 171
  - Psychoacoustics, 79
  - Public cloud, 516
  - Public fields, 316
  - Public-key cryptography, 571
  - Pulse-code modulation (PCM), 58
  - Punched cards, 9, 10
  - Purdue University, 28
  - Pushing items, onto stack, 243
  - Python, 296
    - if and while statements in, 308
    - input statement in, 307
    - reserved words in, 305
    - variable declaration and, 304
- Q**
- Quadratic time, 610
  - Queries, 399
    - in SQL, 404–405
  - Questions, in problem solving, 193
  - Queues, 242, 243–244, 247, 258
    - FIFO, 457
    - priority queue, 460
    - routes stored in, 263*f*
  - Queuing model, 458
  - Queuing systems, 457–460
  - Quicksort algorithm, 377
    - discovery of, 377
    - ordering list using, 225*f*
    - selection sort, 224–228
- R**
- Race condition, 620
  - Radiation overdoses, 620
  - Radio-frequency identification technology, 365, 372
  - Radiosity, 474
  - Radix point, 66, 589
  - Rag-doll physics, 484
  - Random access memory (RAM), 123, 134.
    - See also* Main memory
  - Random-number generator, 460
  - Range of cells, spreadsheet, 393
  - Raster-graphics format, 82
  - Rational number, 36
  - Ray tracing, 473
  - Read-only memory (ROM), 134, 330
  - Read/write head, in disk drive, 135, 136
  - Ready state, 345
  - Real data type, 302
  - Real numbers
    - limits on, 589–593
    - representing, 65–68
  - Real-time system, 336
  - Real Video, 85
  - Reclock, 58
  - Record(s) (or object or entity), 207–208, 362, 400
  - Recurrence coding. *See* Run-length encoding
  - Recursion, 221
    - infinite, 223
    - power of, 227
  - Recursive algorithms
    - quicksort, 224–228
    - recursive binary search, 224
    - recursive factorial, 223
    - subprogram statements, 221–222
  - Recursive binary search, 224
  - Recursive call, 221
  - Recursive definition, 249
  - Recursive factorial, 223
  - Red Hat (Linux), 233
  - Reduced-instruction-set computer (RISC)
    - architecture, 16–17
    - RISC chips, 17, 141
  - Reference Model, 504
  - Reference parameters, 268–271
    - value parameters *vs.*, 269*f*
  - Referential ambiguity, 440
  - Reflections, 473

Register, 129  
 in Pep/9, 154, 155

Relational model, 399–403

Relational operators, 300, 300*t*

Relative path name, 372

Relays, 11

Relocatable models, 464

Remington Rand, 16

“Renaming the file,” 367

Rendering, 473  
 for graphics, 484

Rents database table, 403*f*

Repeaters, 504

Repetition construct, in pseudocode algorithm, 173–175

Representation skill, 26

Representational error, 592

Reserved words, 304, 305

Resistive touch screen, 140

Resolution, 82

Response time, 336

Responsibility algorithms, 283, 285–286, 289–291

Reuse, 318  
 inheritance and, 317

Revolutions per minute (RPM), 124, 137

Rewritable DVD, 124

RFID tags, 365, 372

RGB values, 80

Right child, in binary trees, 247

Ring topology, 497

RISC architecture. *See* Reduced-instruction-set computer architecture

Risk analysis, 560

Robotic whiskers, 441

Robotics, 423, 440–445, 470  
 Asimov’s laws of, 443*f*  
 hybrid deliberative/reactive, 443  
 mobile, 440  
 new control paradigm, 443*f*  
 physical components, 443–445  
 sense-plan-act paradigm, 441  
 subsumption architecture, 441–443  
 topological maps and, 443

Robots, 441, 444  
 Aibo, 444  
 fixed, 440  
 mobile, 440  
 physical components of, 443–445  
 Sojourner rover, 444  
 twin, NASA launch of, 444

Role-playing games, 483

ROM. *See* Read-only memory

Room to Read, 23

Root, in binary tree, 247, 250

Root directory, 369

Rosetta stone, 198

Ross, Blake, 331

Rotation delay, 137

Round-off error, 592

Round robin scheduling, 348–350

Route cipher, 570

Routers, 502, 504

Row designations, spreadsheet cells, 389

RPM. *See* Revolutions per minute

Rule-based system, 430

Run-length encoding, 74–75

Running state, 345

## S

S-R latch, 111, 111*f*

Safari browser, 24

Sales estimates, spreadsheets and, 398

Sampling, 78, 78*f*

SARS. *See* Severe acute respiratory syndrome

Savage Beast Technologies, 172

SAW touch screen. *See* Surface acoustic wave touch screen

Scalable Vector Graphics (SVG), 84

Scams, 321–322

SCAN disk scheduling, 376–378

Scanbuy Shopper, 559

Scanner fraud, 402

Scenarios, 283, 284–285

Scheduling algorithms, evaluating, 345

- Schema, 399, 401
- Scheme language, 20, 296
- Scientific disciplines, 27
- Scientific notation, 68
- Scientific visualization systems, 470
- Scriptlets, 542
- Sculley, John, 349
- SDRAM. *See* Synchronous, dynamic RAM
- Search engines, 527–528
- Search for Extraterrestrial Intelligence (SETI), 500–501
- Search trees, 427–429
  - defined, 427
  - for simplified version of Nim, 427–428, 428*f*
- Searching algorithms with arrays, 207
- Second-generation computers
  - hardware, 13
  - software, 20–21
- Secondary memory, operating system and tracking of, 365
- Secondary storage devices, 135–139
  - CDs and DVDs, 138–139
  - flash drives, 139
  - magnetic disks, 136–137, 136*f*
  - magnetic tape, 135, 135*f*
- Secondhand shopping, 407
- Sectors, 136
- Securities and Exchange Commission, U.S., 447
- Security, 557–581
  - antivirus software, 566–567
  - attacks, 567–569
  - authentication credentials, 560
  - back door, 568
  - biometrics, 560
  - Blaster worm, 565
  - buffer overflow, 568
  - CAPTCHA, 563–564, 564*f*
  - ciphers, 569
  - corporate responsibility, 574
  - cryptanalysis, 570
  - cryptography, 569–572
  - decryption, 569
  - denial of service, 569
  - digital certificate, 571
  - digital signature, 571
  - e-commerce and, 408
  - encryption, 569
  - ethical issues associated with blogging, 580–581
  - fingerprint analysis, 564–565, 565*f*
  - information security, 558–560
  - malicious code, 565–566
  - man-in-the-middle, 569
  - password management software, 563
  - passwords, 561–563
  - phishing, 567–568
  - policy, 573
  - portable devices and, 574–575
  - protecting online information, 572–573
  - public-key cryptography, 571
  - smart cards, 560
  - spoofing, 568
  - unauthorized access, 560–565
  - user authentication, 560
  - viruses, 566
  - WikiLeaks, 575–578
- Seek time, 137, 374
- SEI Software Engineering Process Group, 599
- Seismic models, 467
- Select clause, 404–405
- Select operation, in SQL, 405
- Select signals (select control lines), 110
- Select statements, 405
- Selection construct, 173
- Selection sort, 215–217
  - example of, 216*f*
- Selection statements, 298–299, 310
- Self-auditing, 517
- Semantic networks, 425–427, 426*f*
- Semicolons
  - in Pep/9, 201
  - statements ended with, 304
- Semiconductor, 102
- Sense-plan-act paradigm, 441*f*
- Sequential circuit, 104
- Sequential file access, 366

- Sequential search, 208–209
  - average number of comparisons with binary search and, 213*t*
  - in sorted array, 209–211
- Server, in queuing model, 458. *See also* Web servers
- SETI. *See* Search for Extraterrestrial Intelligence
- SETI@Home, 500–501
- Severe acute respiratory syndrome (SARS), 352
- SGML. *See* Standard Generalized Markup Language
- Shading model, 473
- Shadows, 471–472
- Shannon, Claude E., 11
- Shared memory, 124
  - parallel processor, 144, 144*f*
- Shaw, J. C., 424
- Shi Tao, 575
- Shockley, William B., 13
- Shortest job next, 348
- Shortest-*seek-time-first* disk scheduling, 375–376
- Siemens, 181
- Signature detection software, 567
- Signed-magnitude representation, 61–62
- Significant digits, 590
- Silicon and silicon chips, 16, 112
- Silicon Valley, 19
- Simon, Herbert A., 424*b*
- Simple data types, 303
- Simple Mail Transfer Protocol (SMTP), 507
- Simple variables, algorithms with
  - with repetition, 200–206
  - with selection, 199–200
- SIMULA programming language, 72, 296, 458
- Simulated worlds, 482
- Simulation, 5, 453
  - complex systems, 454
  - continuous simulation, 455–456
  - defined, 454
  - discrete-event, 456–457
- Simulation models, 455
  - business and economic forecasting models, 467
  - computational biology, 466–467
  - computing power necessary for, 467–468
  - forecasting models, 463–464
  - hurricane tracking, 464–466
  - meteorological models, 461–466, 461*f*
  - queuing systems, 457–460
  - seismic models, 467
  - weather models, 465*f*
- Simulators, 293
- SIN function, in spreadsheets, 394*f*
- Single contiguous memory management, 338–339
- Single-instruction, multiple-data-stream (SIMD) computers, 17
- Single instructions, multiple data (SIMD) parallelism, 143
- Single quotes, characters enclosed within, 304
- Single-source shortest-path search, 264–265
- Six degrees of separation, 548
- Size factor, 223
- Sketchpad, 462–463
- Slate Corporation, 396
- Small-scale integration circuit, 112*f*, 112*t*
- Small world phenomenon, 548
- Smalltalk, 296
- Smart cards, 560
- Smartphones, 30, 331
  - apps, 596
- SMPs. *See* Symmetric multiprocessors
- SMTP. *See* Simple Mail Transfer Protocol
- SNOBOL4, 293
- Snowden, Edward, 49, 86, 146
- Social networking, 24
  - analysis, 250
  - benefits *vs.* costs of, 519
  - defined, 519
  - ethical issues, 519
  - evolution, 547–548
  - security policy, 573
- Software, 3, 4, 5, 329
  - categories of, 330
  - complexity of, 596–597
  - fifth generation, 23–25
  - first-generation, 19–20
  - fourth generation, 23
  - laptop, 125
  - limits on, 596–604

- notorious software errors, 602–604
- open-source, 232–233
- piracy and, 185, 208, 288
- second-generation, 20–21
- terrorist detection, 250
- testing, 596
- third-generation, 21–23
- tools, 6
- viruses, 185, 566
- Software Arts, 395
- Software engineering, 597–600
- Software Engineering Institute (Carnegie Mellon University), 599
- Software errors, 602–604
  - AT&T down for nine hours, 602–603
  - bugs in government projects, 603–604
  - notorious, 602–604
  - Therac-25, 603
- Software Garden, 396
- Software piracy and copyrighting, 185
- Software quality
  - formal verification, 600–601
  - open-source movement, 601–602
  - software engineering, 597–600
- Software requirements, 598
- Software specifications, 598
- Sojourner rover, 444
- Solid-state disks (SSDs), 124, 138
- Sony Playstation, 483
- Sorenson video codec, 85
- Sorted arrays, 210*f*
  - sequential search in, 209–211
- Sorted lists, 245, 246*f*
- Sorting algorithms, 214–220
  - with arrays, 207
  - bubble sort, 218–219, 218*f*
  - insertion sort, 220, 220*f*
- Sound perception, 77
- Sound waves, 77–78, 77*f*
- Source file, 363
- Source, transistor, 103
- SourceForge, 602
- Space Shuttle Ground Processing System, 600
- Spam, 380
- Spatial video compression, 85
- Special characters, 74
- Special Interest Group for Computer Science
  - Education, 46, 309
- Splitting algorithm, 228*f*
- Spoofing, 568
- Spreadsheets, 23, 389–398, 409
  - analysis of, 397–398
  - applications with, 398
  - circular references and, 396
  - common functions for, 394*f*
  - data and computations in, 390*f*
  - defined, 389
  - formulas for, 391–394
  - function, defined, 392
  - grid of labeled cells in, 389*f*
    - behind some of the cells, 392*f*
- SPSS. *See* Statistical Package for the Social Sciences
- Spyware, 288
- SQL. *See* Structured Query Language
- Square root algorithm, 203–206
  - completed, 205
  - walk-through of, 206*f*
- SSDs. *See* Solid-state disks
- SSI circuit. *See* Small-scale integration circuit
- Stack, Matt, 247
- Stacks, 242–243, 247, 258
  - routes stored in, 260–261, 260*f*
- Standard Generalized Markup Language (SGML), 544
- Stanford University, 28
- Star topology, 497
- Starvation, 376
- Statistical Package for the Social Sciences (SPSS), 22
- STDEV function, in spreadsheets, 394*f*
- Stephenson, Arthur, 604
- Stereo signal, 77–78
- Stibitz, George, 11
- Stonehenge, 9, 10
- STOP branch instruction, 168
- Storage capacity, expressed in binary notation, 125
- Storage devices, 13

- Stored-program concept, 126–141
    - fetch–execute cycle, 134*f*
      - decoding instruction, 133
      - executing instruction, 133–134
      - fetching next instruction, 132–133
      - getting data, 133
    - RAM and ROM, 134
    - secondary storage devices
      - CDs and DVDs, 138–139
      - flash drives, 139
      - magnetic disks, 136–137
      - magnetic tape, 135
    - touch screens, 139–141
    - von Neumann architecture, 128*f*
      - arithmetic/logic unit, 129–130
      - control unit, 130–132
      - input/output units, 130
      - memory, 128–129
  - Strachey, Christopher, 377
  - Strategy games, 483
  - Stress management, soothing software and, 375
  - Strings, 172, 206, 303–304
    - binary search tree built from, 253*f*
  - STRO branch instruction, 167
  - Strong equivalence, 422
  - Strong typing, 301
  - Structure of Scientific Revolutions, The* (book), 295
  - Structured design, 24
  - Structured programming, 23, 307, 309
  - Structured Query Language (SQL), 404–405
    - defined, 404
    - mathematical basis of, 405
    - modifying database content, 405
    - queries, 404–405
  - Styluses, 12
  - Subdirectory, 369
  - Subprograms, 265–271, 284, 314
    - declaration, in VB.NET and C++, 310
    - flow of control, 222*f*
    - nested logic and, 310
    - statements, 221–222
  - Substitution cipher, 569
  - Subsumption architecture, 441–443
  - Subtraction
    - of integers, 302
    - of numbers in other bases, 42
  - SUM function, in spreadsheets, 394*f*
  - Sun Microsystems, 17, 24
  - Superclass, 316
  - Superensembles, 465
  - Superscalar processor, 142, 144
  - Surface acoustic wave (SAW) touch screen, 141
  - Sutherland, Ivan, 462–463*b*
  - SVG. *See* Scalable Vector Graphics (SVG)
  - Swap algorithm, 216
  - Symantec, 567
  - Symbolic logic and relays, 11
  - Symbols
    - arithmetic operations, 302
    - comment, 304
    - relational operators, 300*t*
  - Symmetric encryption, 571
  - Symmetric multiprocessors (SMPs), 144
  - Synapse, 432
  - Synchronous, dynamic RAM (SDRAM), 123
  - Synchronous processing, 143
  - Syntactic ambiguity, 440
  - Systems
    - complex, 454
    - definition of, 454
    - queuing, 457–460
    - types of, 455
  - Systems programmers, 20–21
  - Systems software, 21, 330
- ## T
- Table, 400
  - Tablet computers, 331
  - Tablets for teaching, 244
  - Tag, 532
    - HTML. *See* Hypertext Markup Language
  - Tandy/Radio Shack, 16
  - Tape drives, 362
  - Target (retailer), 132, 146



- Target game platform, 486–487
- Task-level parallelism, 143, 145
- TCP. *See* Transmission Control Protocol
- TeamAlpha, 368
- Technology use, study of, 170
- Telegraph, Einstein’s description of, 83
- Television and elections, 427
- Telnet, 507
- Temporal video compression, 84–85
- Ten-level binary search tree, 252*f*
- Ten’s complement, 63
- Tenth strand, 100
- Terminal I/O button, 16, 161
- Terminated state, 345
- Terrorist detection software, 250
- Test case, 182
- Test plan, 182
- Testing, 231
  - algorithms, 182–183, 198
  - importance of, 231
  - programs, 182–183
- Text, 68–77
  - ASCII character set, 69–70
  - text compression, 71–77
    - Huffman encoding, 75–77
    - keyword encoding, 71–74
    - run-length encoding, 74–75
  - Unicode character set, 70–71
- Text compression, 71–77
  - Huffman encoding, 75–77
  - keyword encoding, 71–74
  - run-length encoding, 74–75
- Text files, 362–363
- Textile counterfeiting, 606
- Texting, 528
- Texture mapping techniques, 472
- Therac-25, 620
  - software errors, 603
- Thinking machines, 420–423
- Third-generation computer hardware/software, 15–16, 21–22
- Thrashing, 344
- 3D camera, 125
- Three-input AND gate, 101, 101*f*
- Threshold values, 433, 434
- Thumb drive, 139
- TIFF, 363
- Time-driven simulation, 458
- Time sharing, 21–22, 334–335
- Time slice, 348
- Titanic effect, 594
- TLDs. *See* Top-level domains
- TODAY function, in spreadsheets, 394*f*
- Top-down design, 198, 290
  - object-oriented design vs., 282
  - verbs in, 286
- Top-level domains (TLDs), 511–512, 512*f*
- Torvolds, Linus, 601
- Touch ID, 565
- Touch screens, 139–141, 140*f*
- Traceroute, 507, 507*f*
- Track, 136
- Training, 434
- Transfer rate, 137
- Transistors, 13, 13*f*, 102–104, 102*f*
- Translation process, 291–294
  - compilers, 292
  - interpreters, 292–294
- Transmission Control Protocol (TCP), 506, 507
- Transposition cipher, 570
- Traveling Salesman problem, 618
- Treatise on Differential Equations* (book), 95
- Treatise on the Calculus of Finite Differences* (book), 95
- Trees, 258
  - binary, 247–249
  - binary search, 249–255
  - other operations, 255–256
- Trellix Corporation, 396
- Trojan horse, 288, 566
- True color, 80
- True value, in Boolean data type, 303
- Trump, Donald, 574
- Truth table, 94
  - AND gate, 97*f*, 101*f*
  - combinational circuit and, 105, 106
  - full adder, 109



- NAND gate, 99f
- NOR gate, 100f
- NOT gate, 96f
- OR gate, 98f
- XOR gate, 99f
- Tsunami detection, 464
- Turing, Alan M., 11, 248b, 421, 571, 612, 613–614b
- Turing Award, 11
- Turing machine, 11, 612–615, 615f
- Turing test, 421–423, 422f
- Turnaround time, 345
- Twitter, 411, 447, 519
- Two's complement, 64–65

## U

- UDP. *See* User Datagram Protocol
- Unary instructions, 155
- Unauthorized access, 560–565
- Unconditional branch, 167
- Underflow, 592
- Undirected graph, 256
- Unicode character set, 70–71, 71f, 302, 306, 362
- Uniform Resource Locator (URL), 527, 549
- Union operation, in SQL, 405
- UNIVAC I computer, 11, 46
- Universal History of Computing, The* (book), 37
- Universal Product Code (UPC), 402, 559
- Universal serial bus (USB), 125, 139
- University of Pennsylvania, 28
- UNIX, 23
  - directory tree, 371, 371f
  - operating system, 331
    - file protection settings in, 367
  - workstations, 17
- Unordered lists, 245
- Unsorted arrays, 210f
- Unsorted linked lists, 245f
- UPC. *See* Universal Product Code
- Update statement, in SQL, 405
- Uploads, 502
- URL. *See* Uniform Resource Locator

- USA PATRIOT Act of 2001, 49
- USB. *See* Universal serial bus
- User authentication, 560
- User Datagram Protocol (UDP), 506
- User-friendly software packages, 25
- Users, ever-changing role of, 26
- UTeach Institute, 244

## V

- Vacuum tubes, 13, 13f
- Value parameters, 268–271
  - reference parameters vs., 269f
- Value-returning subprograms, 265, 270
- Values, copying in spreadsheets, 394
- van Dam, Andy, 503
- Variables
  - arrays, 206–207
  - composite, 206–208
  - in pseudocode algorithms, 171
  - records, 207–208
- VB .NET
  - asynchronous processing in, 313
  - end if and end while in, 308
  - if and while statements in, 308
  - input statement in, 307
  - subprogram declaration in, 310
  - uppercase used in, 305
  - variable declaration in, 304
- Vector graphics, 83–84
- Vector representation, of graphics, 83–84
- Veeder, Jane, 469
- Verbs, in top-down design, 286
- Verification
  - formal, 600–601
  - in software life cycle, 598
- Vertex (vertices)
  - adjacent, 257
  - breadth-first search and, 261
  - depth-first search and, 259–261
  - in graphs, 256, 257f
- Very large numbers, representing, 589

- Very-large-scale integration circuit, 112–113, 112*t*  
 Video codecs (COmpressor/DECompressor), 84  
 Video game addiction, 489–490  
 Video, representing, 84–85  
 Vinyl record album, 79  
 Virtual computers, 153–159  
 Virtual environments, 26  
 Virtual games, 140  
 Virtual machines, 293, 334–335  
 Virtual memory, 343  
 Virtual world, 482, 484–485  
 Viruses, 185, 566  
 VisiCalc, 395  
 Visio, 363  
 Visual system, human, 470  
 VLSI chips, 112  
 Voice recognition, 436, 438–439  
 Voice synthesis, 436, 437–438  
 Voiceprint, 439  
 Voltage levels, 94  
 von Leibniz, Gottfried Wilhelm, 9  
 von Neumann, John, 11, 126, 195, 248*b*  
 von Neumann architecture, 128*f*, 298  
     arithmetic/logic unit, 129–130  
     control unit, 130–132  
     input/output units, 130  
     memory, 128–129  
 Voyager 1 and Voyager 2 space probes, 472  
 VQF format, 79
- W**
- Waiting, in queuing systems, 457–458  
 Waiting state, 345  
 Walk-through, 599  
 Walker, Henry, 588, 602–603  
 WAN. *See* Wide-area network  
 Warford, Stanley, 153  
 WARPITOUT, 469  
 Watson, computing engine for smartphone apps, 596  
 Watson, Thomas, 25  
 WAV format, 79, 80
- Wayne, Ronald, 349  
 Weak equivalence, 421  
 Weather forecasting, 463–464  
 Weather models, 456  
 Web (World Wide Web), 6, 336, 407, 525–550.  
     *See also* Internet  
     Consortium, 538  
     Berners-Lee and, 538  
 Web analytics, 530–531  
 Web browsers, 526. *See also* Browsers  
 Web pages, 526  
     interactive, 541–543  
 Web servers, 497, 526  
 Web surfing, 3, 25  
 Weblogs. *See* Blogs and blogging  
 Websites, 526  
 Westergren, Tim, 172  
 What-if analysis, 398  
 Where clause, 404  
 While loop, count-controlled loop and, 201  
 While statement, 308  
     in demonstration languages, 308  
     event-controlled loops and, 201–202  
 Whiskers, robotic, 441  
 Wi-Fi, 543, 574  
 Wide-area network (WAN), 498  
 Wiki, 575  
 WikiLeaks, 575–578  
 Wikipedia, 24  
 Wilkes, Maurice, 110, 126  
 Windows 10, 125, 331  
     directory tree, 370*f*  
     operating system, 23, 24  
 Windows XP, 5  
 Wired magazine, 331  
 Wireless access points, 499  
 Wireless networking technology, 543  
 Wireless networks, 499  
 Wireless TV cameras, 282  
 Wood, John, 23  
 Word processors, 23  
 .WORD pseudo-op, 165  
 WordPerfect, 23

Words, 47  
    meanings for, 302  
    reserved, 304, 305  
Working directory, 370  
Workplace monitoring, 273–274  
Workplace privacy, 273–274  
Workstations, 16, 335  
World of Warcraft players, addiction and, 489  
World permissions, in UNIX operating system, 367  
World Wide Web. *See* Web  
Worms, 566  
Worst fit, 341  
Wozniak, Steve, 16, 349  
WPS-8 word processing product, 395  
Writing and counting, 12  
Wylie, Christopher, 574

## X

XBox (Microsoft), 483  
Xerox, 18

Xerox PARC, 23  
XML. *See* Extensible Markup Language  
XO laptops, 30  
XOR gate, 98–99, 99f  
XSL. *See* Extensible Stylesheet Language

## Y

Yahoo!, 527

## Z

Z specification language, 377  
Z1–Z4 machines, 181  
Zero, importance of, 37  
Zuckerberg, Mark, 547, 574  
Zuse, Konrad, 11, 181*b*  
Zuse machines, 181